

28 mΩ $R_{DS(ON)}$ 3A High-Side Load Switch in 1.2 mm x 1.2 mm FDFN Package

Features

- 28 mΩ $R_{DS(ON)}$
- 3A Continuous Operating Current
- Space-Saving 1.2 mm x 1.2 mm 4-Lead FDFN Package
- Input Voltage Range: 1.7V to 5.5V
- Internal Level Shift for CMOS/TTL Control Logic
- Ultra-Low Quiescent Current
- Micropower Shutdown Current
- Soft-Start: MIC94042, MIC94043
- Load Discharge Circuit: MIC94041, MIC940483
- Ultra-Fast Turn-Off Time
- -40°C to +125°C Junction Operating Temperature

Applications

- Cellular Phones
- Portable Navigation Devices (PND)
- Personal Media Players (PMP)
- Ultra-Mobile PCs
- Portable Instrumentation
- Other Portable Applications
- PDAs
- Industrial and Datacom Equipment

Package Type

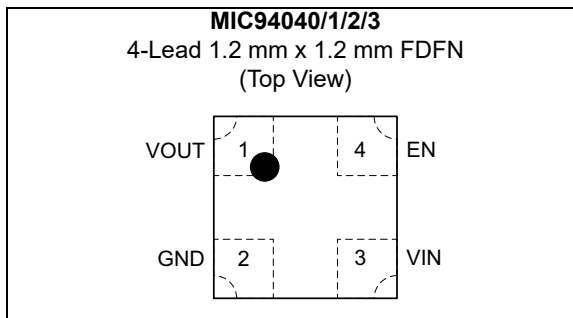

General Description

The MIC94040, MIC94041, MIC94042, and MIC94043 are a family of high-side load switches designed to operate from 1.7V to 5.5V input voltage. The load switch pass element is an internal 28 mΩ $R_{DS(ON)}$ P-channel MOSFET which enables the device to support up to 3A of continuous current. Additionally, the load switch supports 1.5V logic level control and shutdown features in a tiny 1.2 mm x 1.2 mm 4-lead FDFN package.

The MIC94040 and MIC94041 feature rapid turn on, while the MIC94042 and MIC94043 provide a slew rate controlled soft-start turn-on of 100 μs. The soft-start feature is provided to prevent an in-rush current event from pulling down the input supply voltage.

The MIC94041 and MIC94043 feature an active load discharge circuit which switches in a 200Ω load when the switch is disabled to automatically discharge a capacitive load.

An active pull-down on the enable input keeps the MIC94040/1/2/3 in a default OFF state until the enable pin is pulled above 1.2V. Internal level shift circuitry allows low voltage logic signals to switch higher supply voltages. The enable voltage can be as high as 5.5V and is not limited by the input voltage.

The MIC94040/1/2/3 operating voltage range makes them ideal for Lithium ion and NiMH/NiCad/Alkaline battery powered systems, as well as non-battery powered applications. The devices provide low quiescent current and low shutdown current to maximize battery life.

MIC94040/1/2/3

Typical Application Circuits

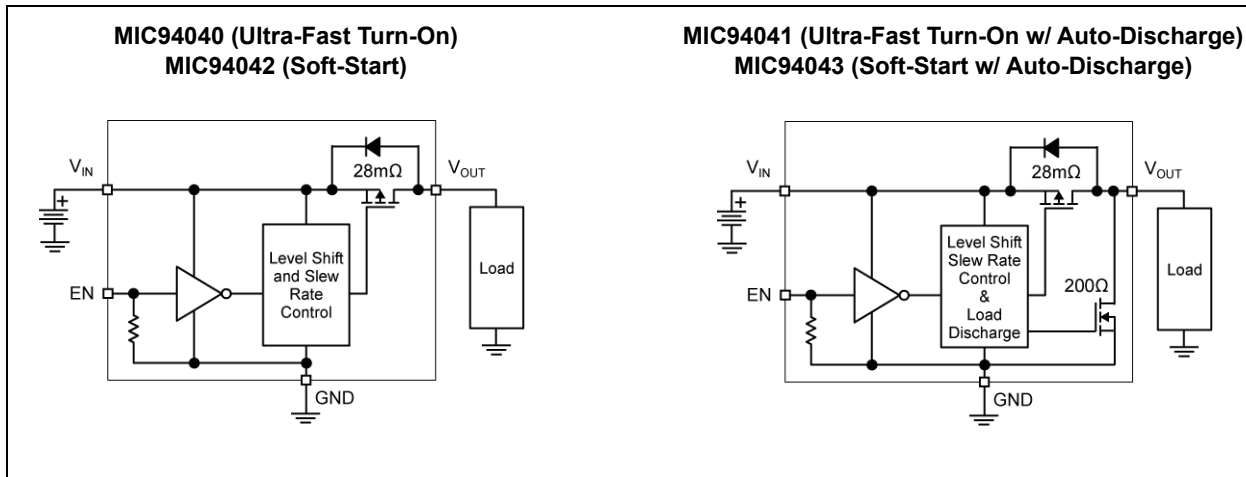

1.0 ELECTRICAL CHARACTERISTICS

Absolute Maximum Ratings †

Input Voltage (V_{IN})	+6V
Enable Voltage (V_{EN})	+6V
Continuous Drain Current (I_D) (Note 1)	
$T_A = +25^\circ\text{C}$	$\pm 3\text{A}$
$T_A = +85^\circ\text{C}$	$\pm 2\text{A}$
Pulsed Drain Current (I_{DP}) (Note 2)	$\pm 6.0\text{A}$
Continuous Diode Current (I_S) (Note 3)	-50 mA
ESD Rating (HBM, Note 4)	3 kV

Operating Ratings ††

Input Voltage (V_{IN})	+1.7V to +5.5V
----------------------------------	----------------

† **Notice:** Stresses above those listed under “Absolute Maximum Ratings” may cause permanent damage to the device. This is a stress rating only and functional operation of the device at those or any other conditions above those indicated in the operational sections of this specification is not intended. Exposure to maximum rating conditions for extended periods may affect device reliability.

†† **Notice:** The device is not guaranteed to function outside its operating ratings.

Note 1: With thermal contact to PCB. See Thermal Considerations section.

2: Pulse width <300 μs with <2% duty cycle.

3: Continuous body diode current conduction (reverse conduction, i.e. V_{OUT} to V_{IN}) is not recommended.

4: Devices are ESD sensitive. Handling precautions recommended. Human body model, 1.5 k Ω in series with 100 pF.

ELECTRICAL CHARACTERISTICS

Electrical Characteristics: $T_A = +25^\circ\text{C}$, **bold** values indicate $-40^\circ\text{C} \leq T_A \leq +85^\circ\text{C}$, unless noted.

Parameter	Symbol	Min.	Typ.	Max.	Units	Conditions
Enable Threshold Voltage	V_{EN_TH}	0.4	—	1.2	V	$V_{IN} = 1.7\text{V to } 4.5\text{V}$, $I_D = -250 \mu\text{A}$
Quiescent Current	I_Q	—	0.1	1	μA	$V_{IN} = V_{EN} = 5.5\text{V}$, $I_D = \text{OPEN}$ Measured on V_{IN} MIC94040/1
		—	7	10		$V_{IN} = V_{EN} = 5.5\text{V}$, $I_D = \text{OPEN}$ Measured on V_{IN} MIC94042/3
Enable Input Current	I_{EN}	—	2.5	4	μA	$V_{IN} = V_{EN} = 5.5\text{V}$, $I_D = \text{OPEN}$
Quiescent Current (Shutdown)	I_{SHUT-Q}	—	0.1	1	μA	$V_{IN} = +5.5\text{V}$, $V_{EN} = 0\text{V}$, $I_D = \text{OPEN}$ Measured on V_{IN}
OFF State Leakage Current	$I_{SHUT-SWITCH}$	—	0.1	1	μA	$V_{IN} = +5.5\text{V}$, $V_{EN} = 0\text{V}$, $I_D = \text{SHORT}$ Measured on V_{IN} , Note 1
P-Channel Drain-to-Source ON Resistance	$R_{DS(ON)}$	—	28	55	$\text{m}\Omega$	$V_{IN} = +5.0\text{V}$, $I_D = -100 \text{mA}$, $V_{EN} = 1.5\text{V}$
		—	30	60		$V_{IN} = +4.5\text{V}$, $I_D = -100 \text{mA}$, $V_{EN} = 1.5\text{V}$
		—	33	65		$V_{IN} = +3.6\text{V}$, $I_D = -100 \text{mA}$, $V_{EN} = 1.5\text{V}$
		—	45	90		$V_{IN} = +2.5\text{V}$, $I_D = -100 \text{mA}$, $V_{EN} = 1.5\text{V}$
		—	72	145		$V_{IN} = +1.8\text{V}$, $I_D = -100 \text{mA}$, $V_{EN} = 1.5\text{V}$
		—	82	160		$V_{IN} = +1.7\text{V}$, $I_D = -100 \text{mA}$, $V_{EN} = 1.5\text{V}$

Note 1: Measured on the MIC94040YFL and MIC94042YFL.

MIC94040/1/2/3

ELECTRICAL CHARACTERISTICS (CONTINUED)

Electrical Characteristics: $T_A = +25^\circ\text{C}$, **bold** values indicate $-40^\circ\text{C} \leq T_A \leq +85^\circ\text{C}$, unless noted.

Parameter	Symbol	Min.	Typ.	Max.	Units	Conditions
Load Discharge Resistance	$R_{\text{DISCHARGE}}$	—	250	400	Ω	$V_{\text{IN}} = +3.6\text{V}$, $I_{\text{TEST}} = 1\text{ mA}$, $V_{\text{EN}} = 0\text{V}$ MIC94041/3
Dynamic Electrical Characteristics						
Turn-On Delay	$t_{\text{ON_DLY}}$	—	0.97	1.5	μs	$V_{\text{IN}} = +3.6\text{V}$, $I_{\text{D}} = -100\text{ mA}$, $V_{\text{EN}} = 1.5\text{V}$ MIC94040, MIC94041
		50	106	185		$V_{\text{IN}} = +3.6\text{V}$, $I_{\text{D}} = -100\text{ mA}$, $V_{\text{EN}} = 1.5\text{V}$ MIC94042, MIC94043
Turn-On Rise Time	$t_{\text{ON_RISE}}$	0.5	0.9	5	μs	$V_{\text{IN}} = +3.6\text{V}$, $I_{\text{D}} = -100\text{ mA}$, $V_{\text{EN}} = 1.5\text{V}$ MIC94040, MIC94041
		50	116	200		$V_{\text{IN}} = +3.6\text{V}$, $I_{\text{D}} = -100\text{ mA}$, $V_{\text{EN}} = 1.5\text{V}$ MIC94042, MIC94043
Turn-Off Delay Time	$t_{\text{OFF_DLY}}$	—	100	200	ns	$V_{\text{IN}} = +3.6\text{V}$, $I_{\text{D}} = -100\text{ mA}$, $V_{\text{EN}} = 0\text{V}$
Turn-Off Fall Time	$t_{\text{OFF_FALL}}$	—	20	100	ns	$V_{\text{IN}} = +3.6\text{V}$, $I_{\text{D}} = -100\text{ mA}$, $V_{\text{EN}} = 0\text{V}$

Note 1: Measured on the MIC94040YFL and MIC94042YFL.

TEMPERATURE SPECIFICATIONS

Parameters	Symbol	Min.	Typ.	Max.	Units	Conditions
Temperature Ranges						
Junction Temperature Range	T_J	-40	—	+125	$^\circ\text{C}$	—
Storage Temperature Range	T_S	-55	—	+150	$^\circ\text{C}$	—
Package Thermal Resistances						
Thermal Resistance, 4-Ld FDFN 1.2 mm x 1.2 mm	θ_{JC}	—	90	—	$^\circ\text{C/W}$	—

Note 1: The maximum allowable power dissipation is a function of ambient temperature, the maximum allowable junction temperature and the thermal resistance from junction to air (i.e., T_A , T_J , θ_{JA}). Exceeding the maximum allowable power dissipation will cause the device operating junction temperature to exceed the maximum $+125^\circ\text{C}$ rating. Sustained junction temperatures above $+125^\circ\text{C}$ can impact the device reliability.

2.0 TYPICAL PERFORMANCE CURVES

Note: The graphs and tables provided following this note are a statistical summary based on a limited number of samples and are provided for informational purposes only. The performance characteristics listed herein are not tested or guaranteed. In some graphs or tables, the data presented may be outside the specified operating range (e.g., outside specified power supply range) and therefore outside the warranted range.

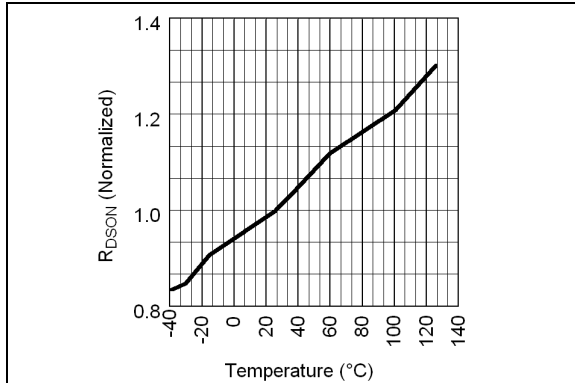

FIGURE 2-1: MIC94040/1/2/3 $R_{DS(ON)}$ Variance vs. Temperature.

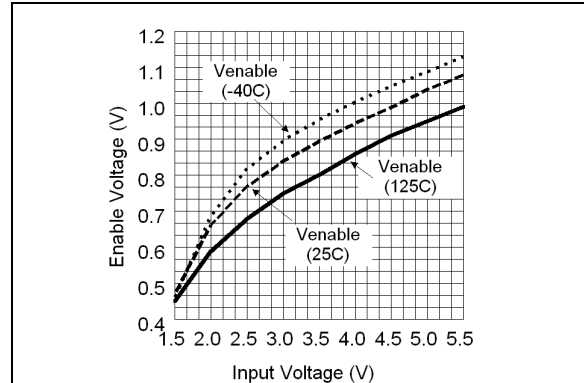

FIGURE 2-4: MIC94040/1 Enable Threshold vs. Input Voltage.

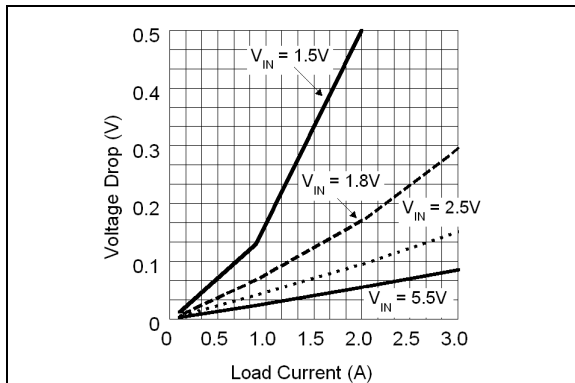

FIGURE 2-2: MIC94040/1/2/3 Voltage Drop vs. Load Current.

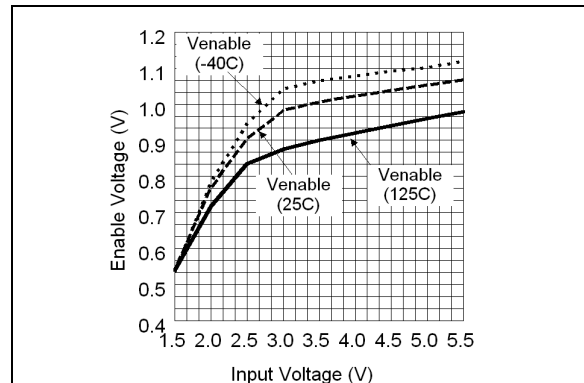

FIGURE 2-5: MIC94042/3 Enable Threshold vs. Input Voltage.

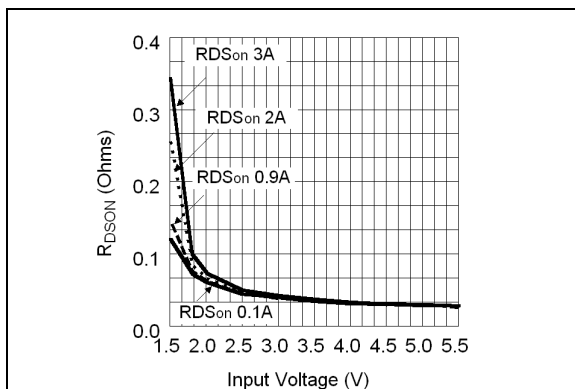

FIGURE 2-3: MIC94040/1/2/3 On Resistance vs. Input Voltage.

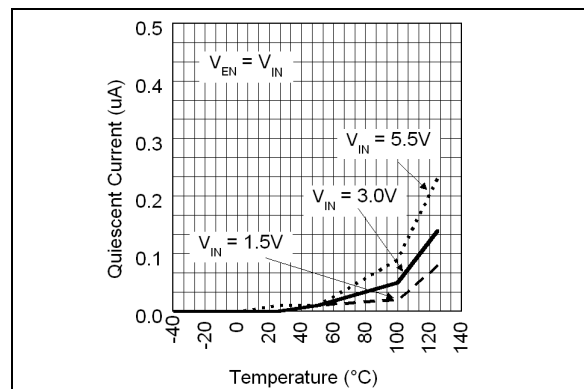

FIGURE 2-6: MIC94040/1 Quiescent Current vs. Temperature.

MIC94040/1/2/3

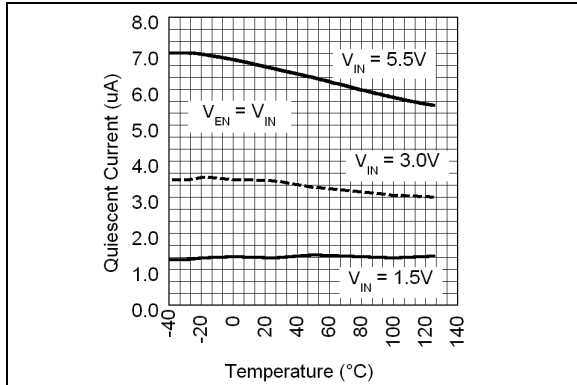

FIGURE 2-7: MIC94042/3 Quiescent Current vs. Temperature.

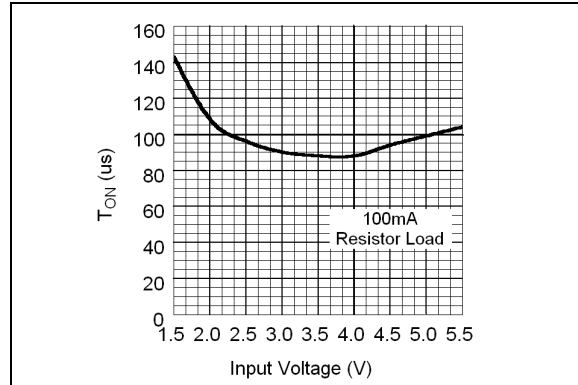

FIGURE 2-10: MIC94042/3 t_{ON} Delay vs. Input Voltage.

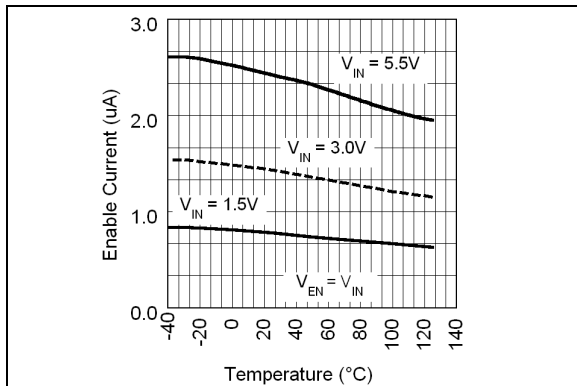

FIGURE 2-8: MIC94042/3 Enable Current vs. Temperature.

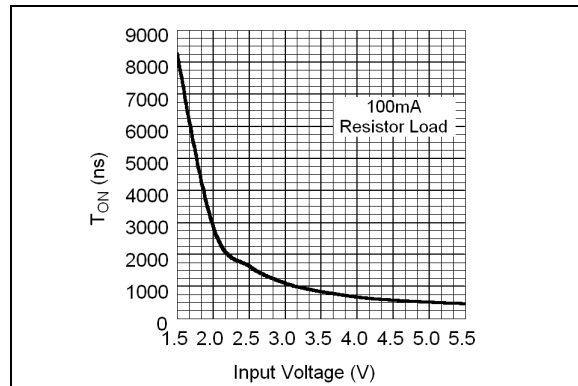

FIGURE 2-11: MIC94040/1 Rise Time vs. Input Voltage.

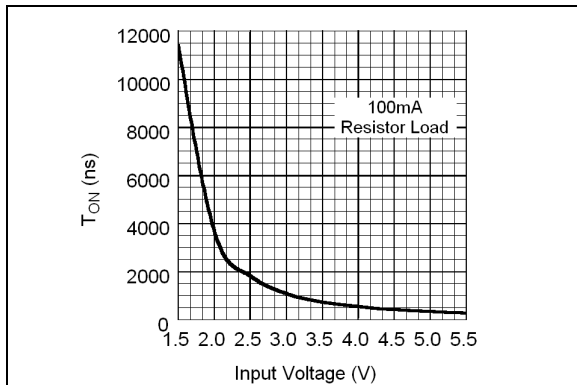

FIGURE 2-9: MIC94040/1 t_{ON} Delay vs. Input Voltage.

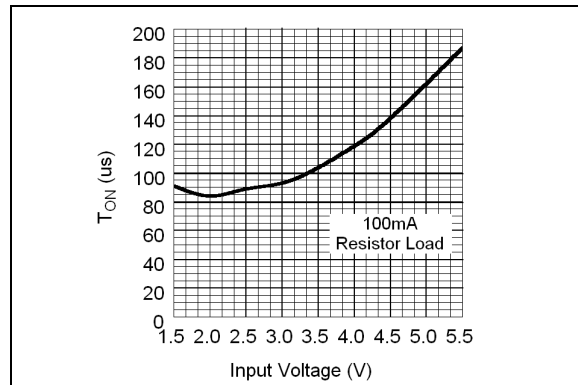

FIGURE 2-12: MIC94042/3 Rise Time vs. Input Voltage.

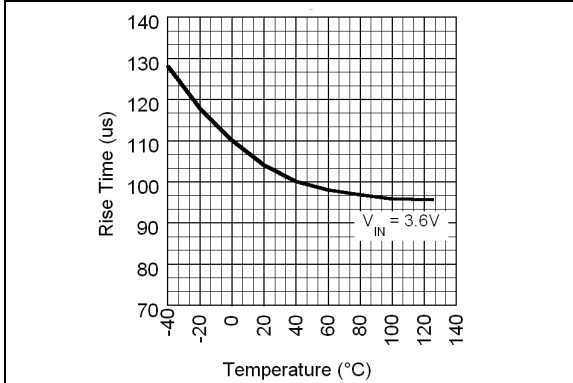

FIGURE 2-13: MIC94040/1 Turn-On Rise Time vs. Temperature.

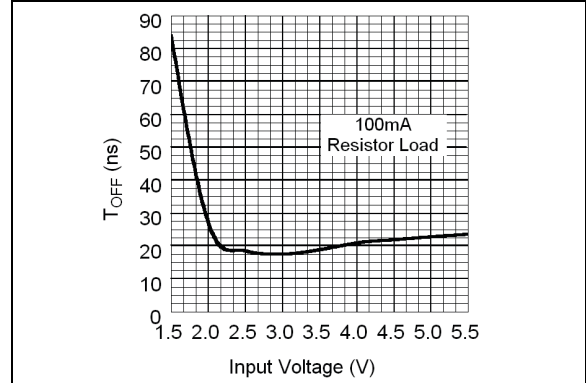

FIGURE 2-16: MIC94042/3 Fall Time vs. Input Voltage.

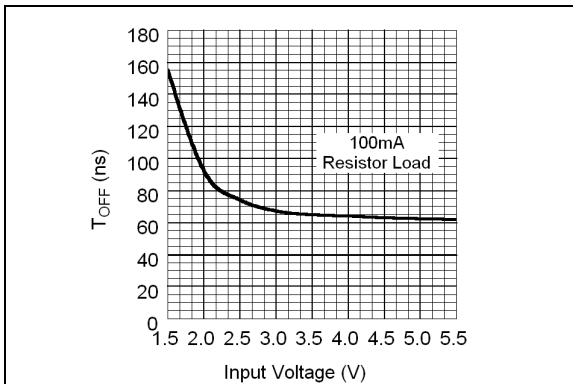

FIGURE 2-14: MIC94042/3 t_{OFF} Delay vs. Input Voltage.

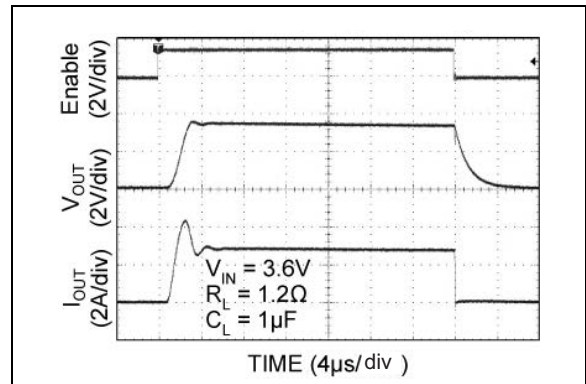

FIGURE 2-17: MIC94040 Turn-On/Turn-Off Timing.

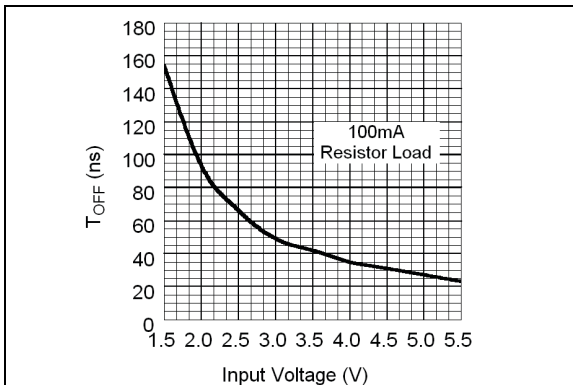

FIGURE 2-15: MIC94040/1/2/3 t_{OFF} Delay vs. Input Voltage.

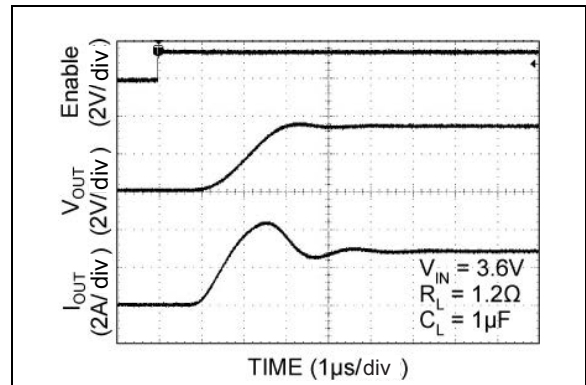

FIGURE 2-18: MIC94040 Turn-On/Turn-Off Timing.

MIC94040/1/2/3

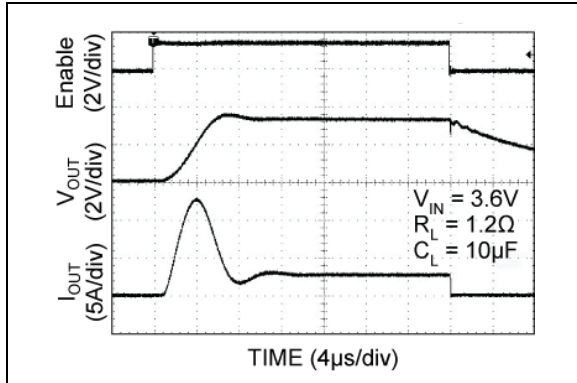

FIGURE 2-19: MIC94040 Turn-On/Turn-Off Timing.

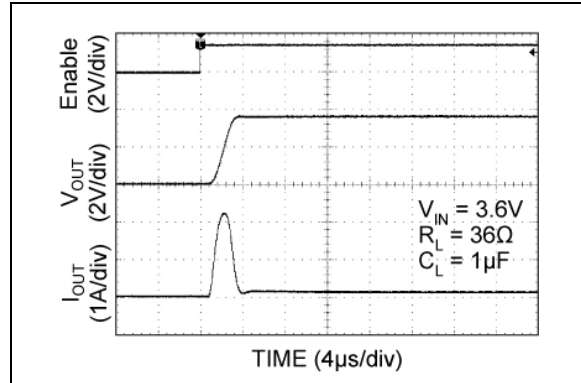

FIGURE 2-22: MIC94040 Turn-On/Turn-Off Timing.

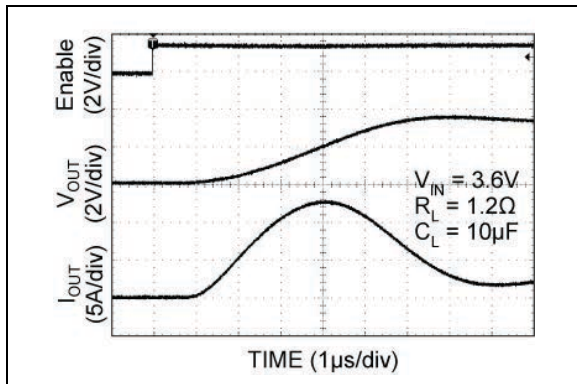

FIGURE 2-20: MIC94040 Turn-On/Turn-Off Timing.

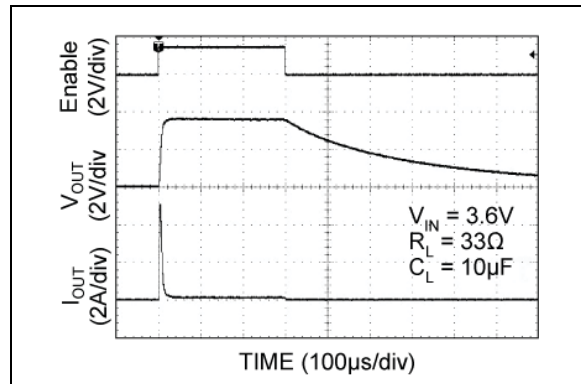

FIGURE 2-23: MIC94040 Turn-On/Turn-Off Timing.

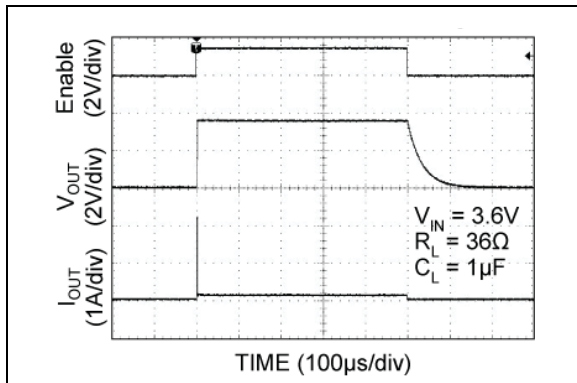

FIGURE 2-21: MIC94040 Turn-On/Turn-Off Timing.

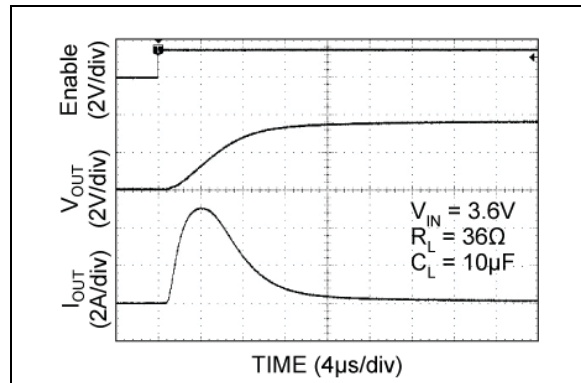

FIGURE 2-24: MIC94040 Turn-On/Turn-Off Timing.

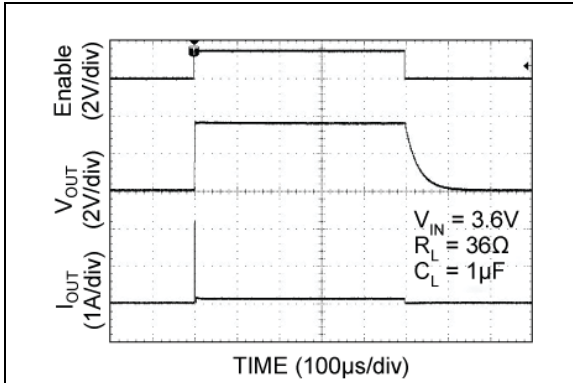

FIGURE 2-25: MIC94041 Turn-On/Turn-Off Timing.

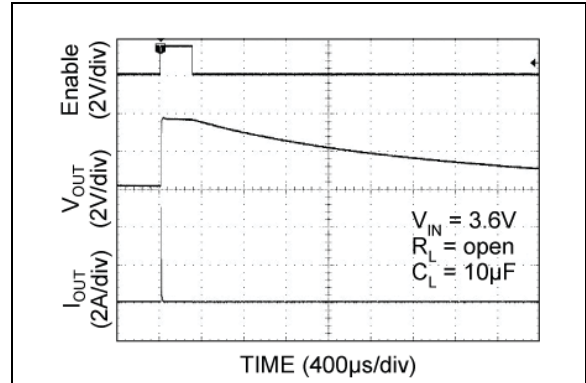

FIGURE 2-28: MIC94041 Turn-On/Turn-Off Timing.

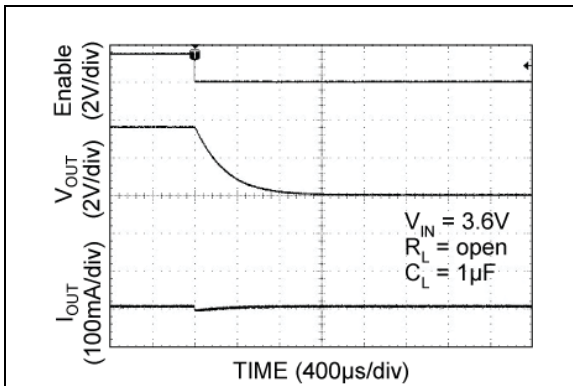

FIGURE 2-26: MIC94041 Turn-On/Turn-Off Timing.

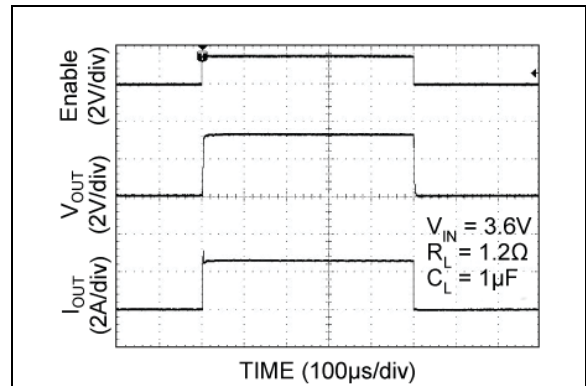

FIGURE 2-29: MIC94041 Turn-On/Turn-Off Timing.

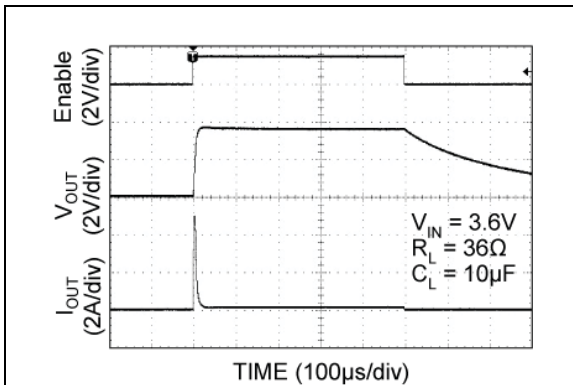

FIGURE 2-27: MIC94041 Turn-On/Turn-Off Timing.

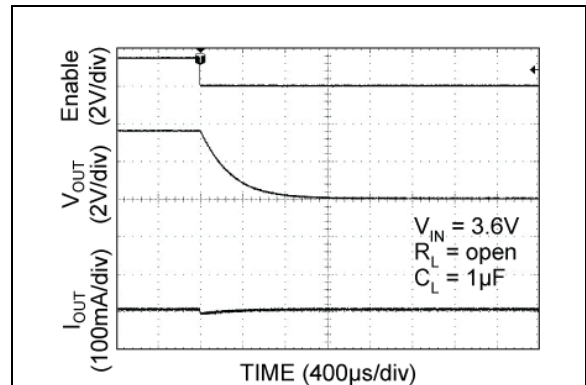

FIGURE 2-30: MIC94041 Turn-On/Turn-Off Timing.

MIC94040/1/2/3

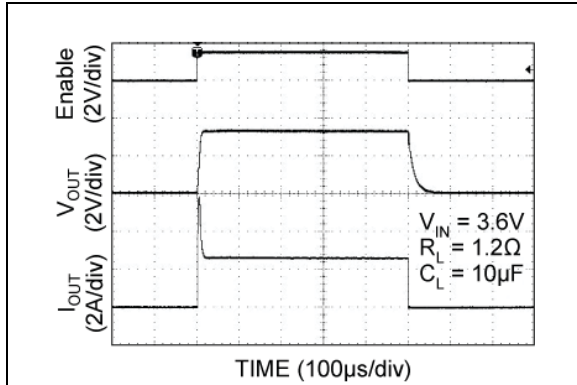

FIGURE 2-31: MIC94041 Turn-On/Turn-Off Timing.

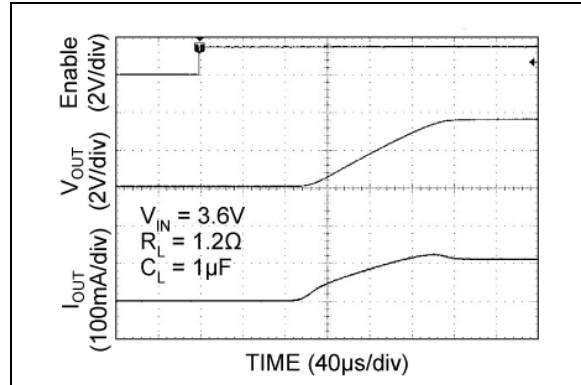

FIGURE 2-34: MIC94042 Turn-On/Turn-Off Timing.

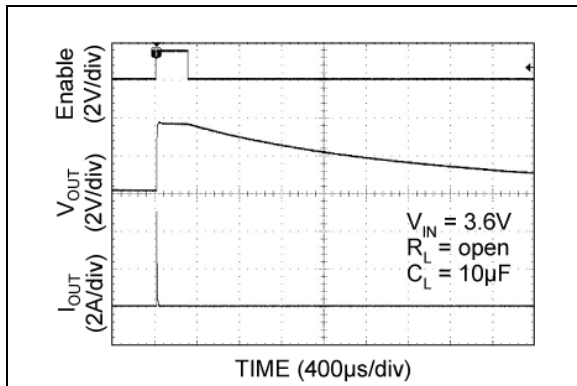

FIGURE 2-32: MIC94041 Turn-On/Turn-Off Timing.

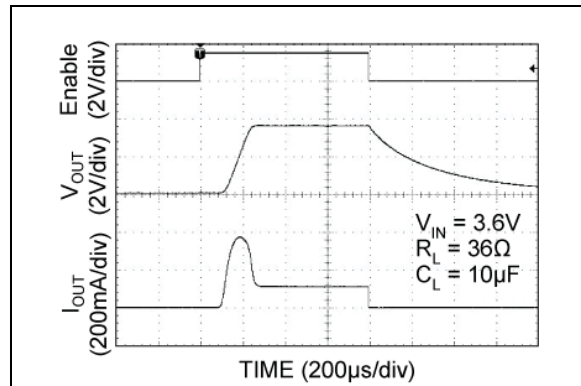

FIGURE 2-35: MIC94042 Turn-On/Turn-Off Timing.

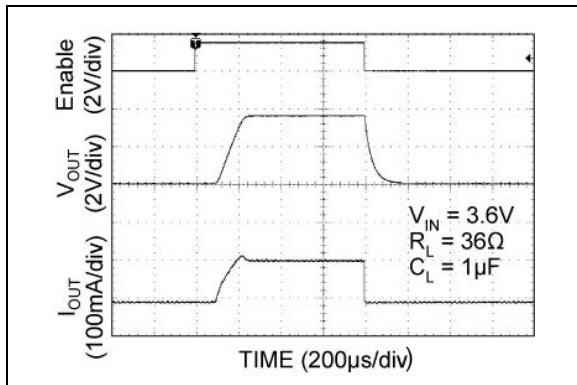

FIGURE 2-33: MIC94042 Turn-On/Turn-Off Timing.

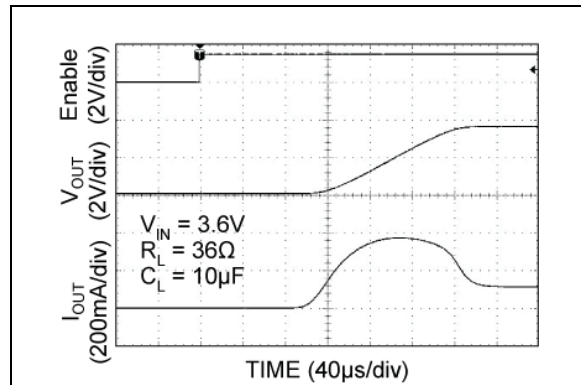

FIGURE 2-36: MIC94042 Turn-On/Turn-Off Timing.

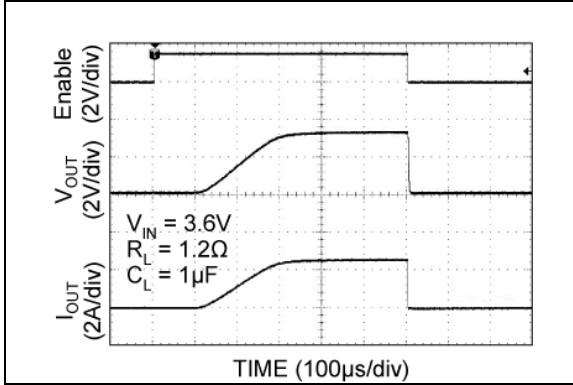

FIGURE 2-37: MIC94042 Turn-On/Turn-Off Timing.

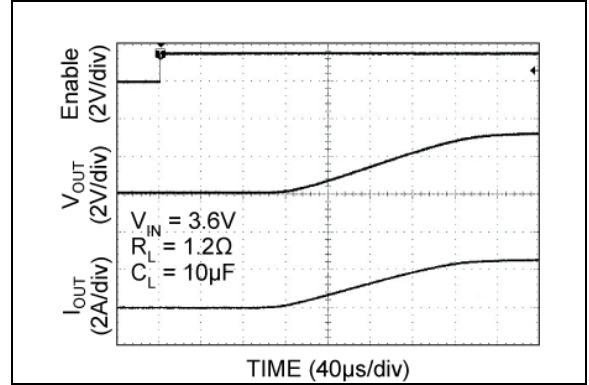

FIGURE 2-40: MIC94042 Turn-On/Turn-Off Timing8.

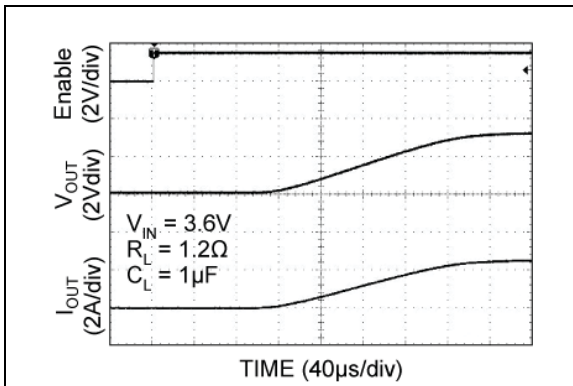

FIGURE 2-38: MIC94042 Turn-On/Turn-Off Timing.

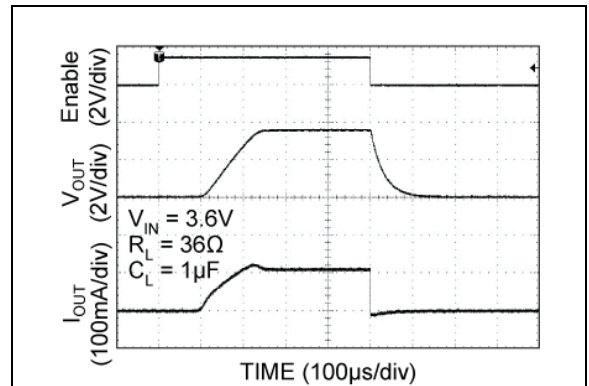

FIGURE 2-41: MIC94043 Turn-On/Turn-Off Timing.

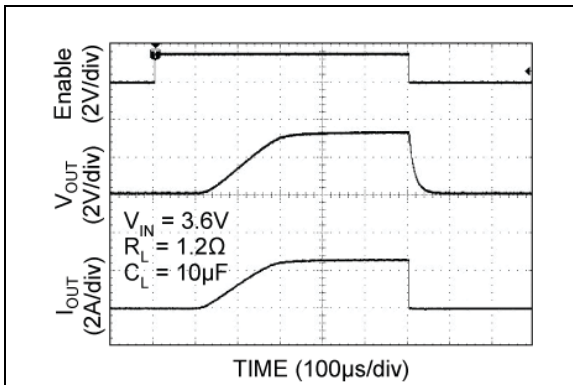

FIGURE 2-39: MIC94042 Turn-On/Turn-Off Timing.

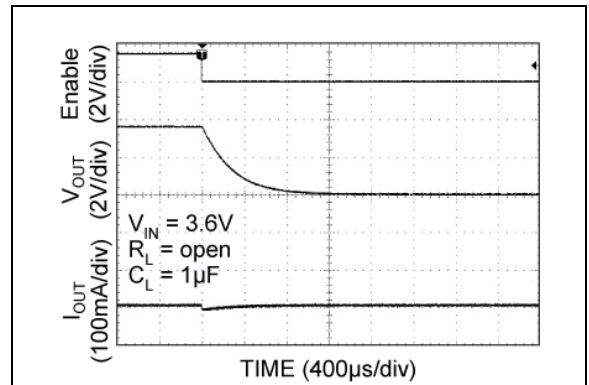

FIGURE 2-42: MIC94043 Turn-On/Turn-Off Timing.

MIC94040/1/2/3

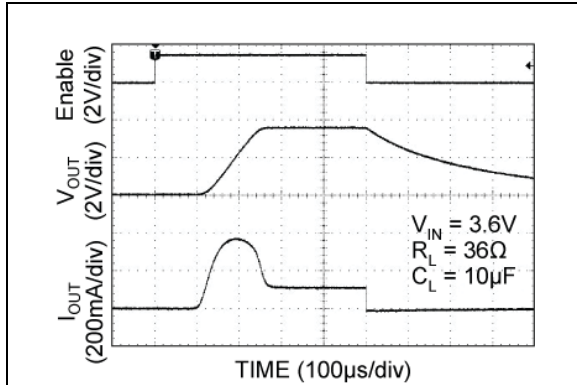

FIGURE 2-43: MIC94043 Turn-On/Turn-Off Timing.

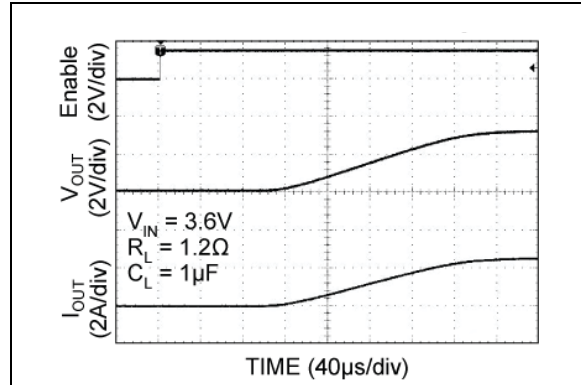

FIGURE 2-46: MIC94043 Turn-On/Turn-Off Timing.

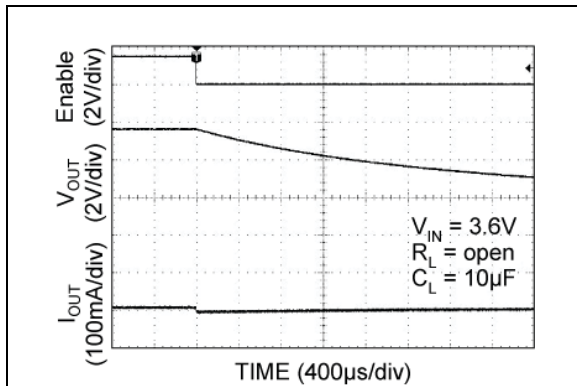

FIGURE 2-44: MIC94043 Turn-On/Turn-Off Timing.

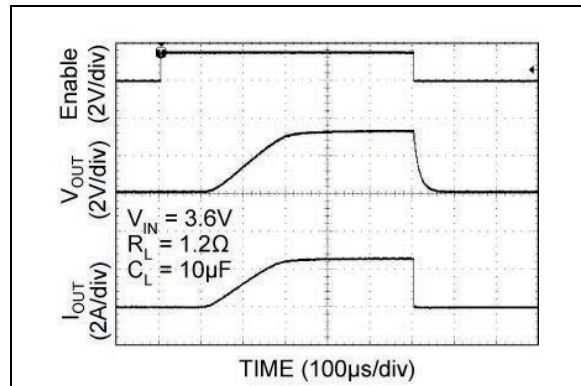

FIGURE 2-47: MIC94043 Turn-On/Turn-Off Timing.

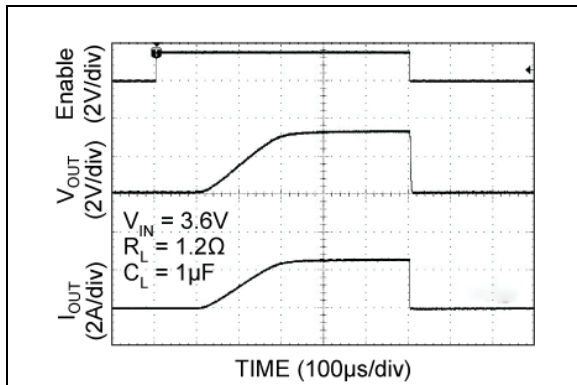

FIGURE 2-45: MIC94043 Turn-On/Turn-Off Timing.

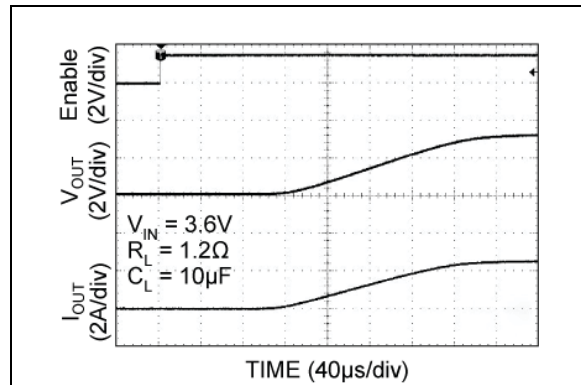

FIGURE 2-48: MIC94043 Turn-On/Turn-Off Timing.

3.0 PIN DESCRIPTIONS

The descriptions of the pins are listed in [Table 3-1](#).

TABLE 3-1: PIN FUNCTION TABLE

Pin Number	Pin Name	Description
1	V _{OUT}	Drain of P-Channel MOSFET.
2	GND	Ground. Should be connected to electrical ground.
3	V _{IN}	Source of P-Channel MOSFET.
4	EN	Enable (Input): Active-high CMOS/TTL control input for switch. Internal ~2 M Ω pull-down resistor. Output will be off if this pin is left floating.

MIC94040/1/2/3

4.0 APPLICATION INFORMATION

4.1 Power Dissipation Considerations

As with all power switches, the current rating of the switch is limited mostly by the thermal properties of the package and the PCB on which it's mounted. There is a simple Ohm's law type relationship between thermal resistance, power dissipation, and temperature that are analogous to an electrical circuit.

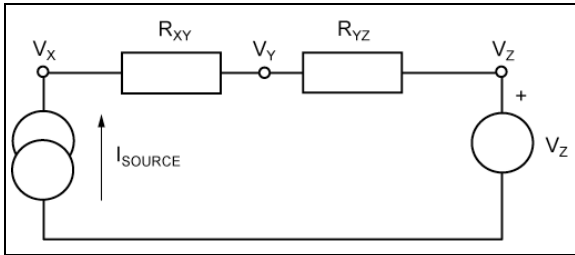

FIGURE 4-1: Simple Electrical Circuit.

From this simple circuit, one can calculate V_X if one knows I_{SOURCE} , V_Z , and the resistor values for R_{XY} and R_{YZ} using Equation 4-1.

EQUATION 4-1:

$$V_X = I_{SOURCE} \times (R_{XY} + R_{YZ}) + V_Z$$

Thermal circuits can be considered using these same rules and can be drawn similarly by replacing current sources with power dissipation (in Watts), resistance with thermal resistance (in °C/W), and voltage sources with temperature (in °C).

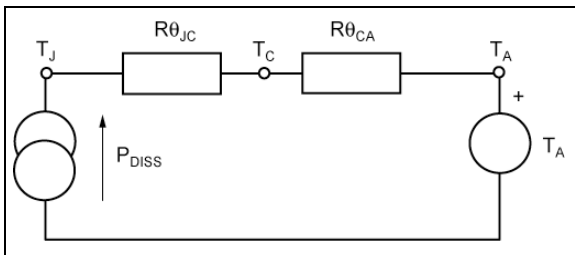

FIGURE 4-2: Simple Thermal Circuit.

By replacing the variables in the equation for V_X , one can find the junction temperature (T_J) from power dissipation, ambient temperature, and then know thermal resistance of the PCB ($R_{\theta_{CA}}$) and the package ($R_{\theta_{JC}}$).

EQUATION 4-2:

$$T_J = P_{DISS} \times (R_{\theta_{JC}} + R_{\theta_{CA}}) + T_A$$

P_{DISS} is calculated as $I_{SWITCH}^2 \times R_{SW(MAX)}$. $R_{\theta_{JC}}$ is found in the [Temperature Specifications](#) section of this data sheet and $R_{\theta_{CA}}$ (the PCB thermal resistance) values for various PCB copper areas is discussed in [Designing with Low Dropout Voltage Regulators](#).

4.1.1 AN EXAMPLE

A switch is intended to drive a 2A load and is placed on a PCB that has a ground plane area of at least 25 mm by 25 mm (625 mm²). The voltage source is a Li-ion battery with a lower operating threshold of 3V and the ambient temperature of the assembly can be up to 50°C.

Summary of variables:

- $I_{SW} = 2A$
- $V_{IN} = 3V$ to 4.2V
- $T_A = 50^\circ C$
- $R_{\theta_{JC}} = 90^\circ C/W$
- $R_{\theta_{CA}} = 53^\circ C/W$ (as read from [Figure 4-3](#))

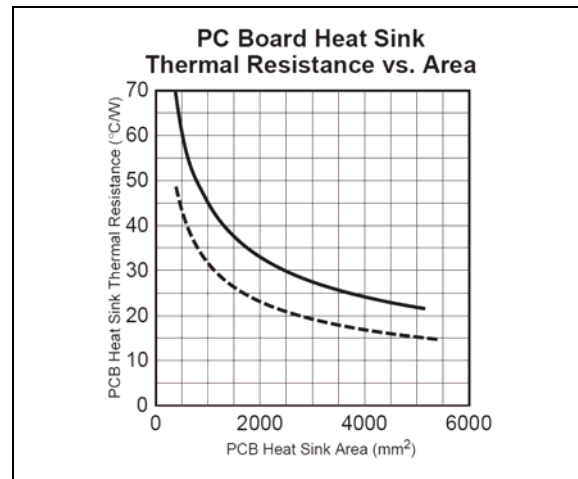

FIGURE 4-3: Excerpt from the LDO Book.

EQUATION 4-3:

$$P_{DISS} = I_{SW}^2 \times R_{SW(MAX)}$$

The worst case switch resistance ($R_{SW(MAX)}$) at the lowest V_{IN} of 3V is not available in the data sheet, so the next lowest value of V_{IN} is used.

$R_{SW(MAX)}$ at 2.5V is 90 m Ω .

If this were a figure for worst case $R_{SW(MAX)}$ for 25°C, an additional consideration is to allow for the maximum junction temperature of 125°C, the actual worst case resistance in this case can be 30% higher (See [Figure 2-1](#)). However, 90 m Ω is the maximum over temperature.

EQUATION 4-4:

$$T_J = 2^2 \times 0.090 \times (90 + 53) + 50 = 101^\circ C$$

This is below the maximum of 125°C.

MIC94040/1/2/3

5.0 PACKAGING INFORMATION

5.1 Package Marking Information

4-Lead FDFN*

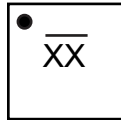

Example

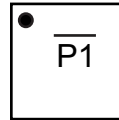

TABLE 5-1: MARKING CODES

Part Number	Marking Code	Features
MIC94040YFL-TR	P4	Fast Turn-On
MIC94041YFL-TR	P1	Fast Turn-On, Load Discharge
MIC94042YFL-TR	P2	Soft-Start
MIC94043YFL-TR	P3	Soft-Start, Load Discharge

<p>Legend:</p> <ul style="list-style-type: none"> XX...X Product code or customer-specific information Y Year code (last digit of calendar year) YY Year code (last 2 digits of calendar year) WW Week code (week of January 1 is week '01') NNN Alphanumeric traceability code (e3) Pb-free JEDEC® designator for Matte Tin (Sn) * This package is Pb-free. The Pb-free JEDEC designator (e3) can be found on the outer packaging for this package. •, ▲, ▼ Pin one index is identified by a dot, delta up, or delta down (triangle mark).
<p>Note: In the event the full Microchip part number cannot be marked on one line, it will be carried over to the next line, thus limiting the number of available characters for customer-specific information. Package may or may not include the corporate logo.</p> <p>Underbar (¯) and/or Overbar (˘) symbol may not be to scale.</p>

4-Lead FDFN Package Outline & Recommended Land Pattern

TITLE

4 LEAD FDFN 1.2x1.2 mm PACKAGE (Flip Chip) OUTLINE & RECOMMENDED LAND PATTERN

DRAWING #	FDFN1212-4LD-PL-1	UNIT	MM
Lead Frame	NiPdAu	Lead Finish	NiPdAu

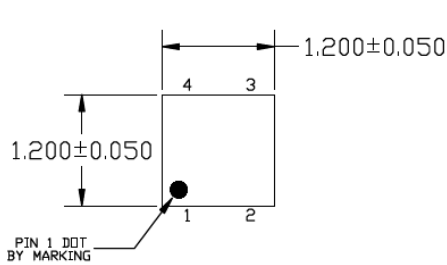

TOP VIEW

NOTE: 1, 2, 3

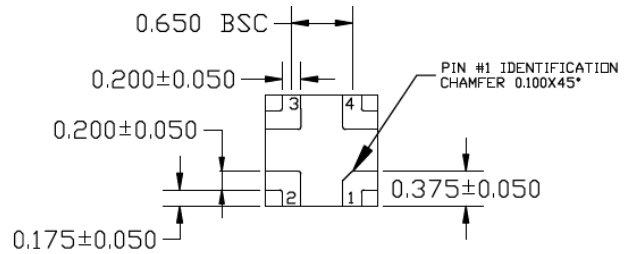

BOTTOM VIEW

NOTE: 1, 2, 3

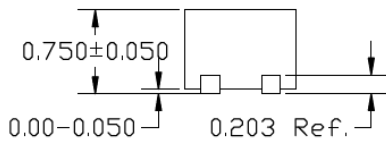

END VIEW

NOTE: 1, 2, 3

NOTE:

1. MAX PACKAGE WARPAGE IS 0.05 MM
2. MAX ALLOWABLE BURR IS 0.076MM IN ALL DIRECTIONS
3. PIN #1 IS ON TOP WILL BE LASER MARKED
4. CYAN SHADED AREAS INDICATE OPTIONAL SOLDER STENCIL OPENING FOR IMPROVED THERMAL PERFORMANCE

Note: For the most current package drawings, please see the Microchip Packaging Specification located at <http://www.microchip.com/packaging>.

MIC94040/1/2/3

POD-Land Pattern drawing #FDFN1212-4LD-PL-1

RECOMMENDED LAND PATTERN

NOTE: 4

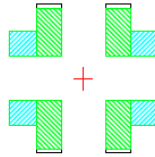

STACKED-UP

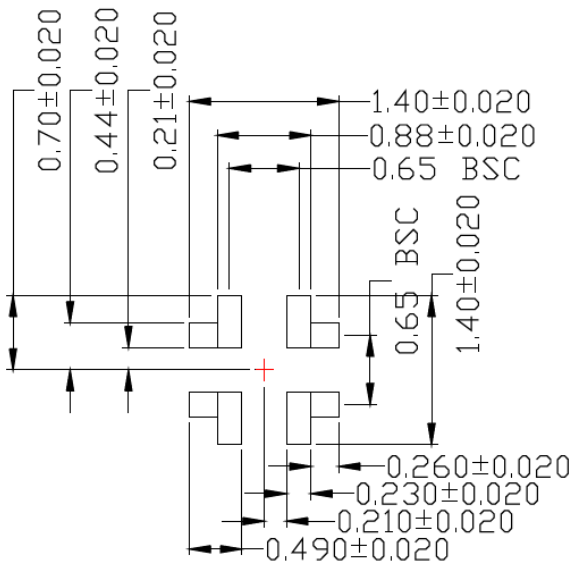

EXPOSED METAL TRACE

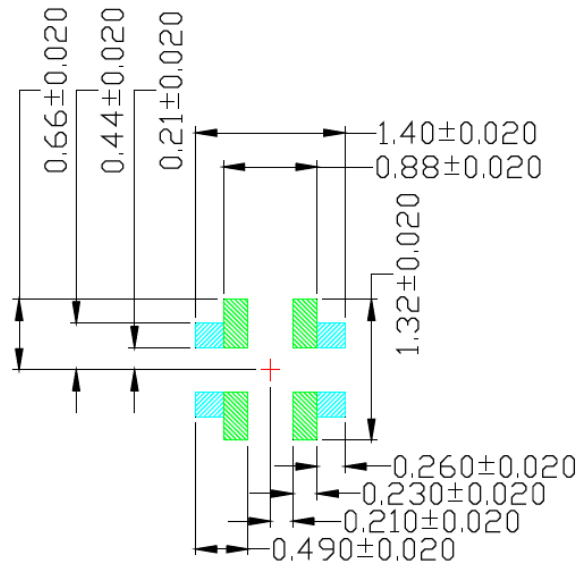

SOLDER STENCIL OPENING

Note: For the most current package drawings, please see the Microchip Packaging Specification located at <http://www.microchip.com/packaging>.

APPENDIX A: REVISION HISTORY

Revision A (November 2021)

- Converted Micrel document MIC94040/1/2/3 to Microchip data sheet template DS20006607A.
- Minor grammatical text changes throughout.

MIC94040/1/2/3

NOTES:

PRODUCT IDENTIFICATION SYSTEM

To order or obtain information, e.g., on pricing or delivery, contact your local Microchip representative or sales office.

Device	<u>X</u>	<u>XX</u>	<u>-XX</u>	Examples:
Part No.	Junction Temp. Range	Package	Media Type	
Device:	MIC94040:	28 mΩ R _{DS(ON)} 3A High-Side Load Switch with Fast Turn-On		a) MIC94040YFL-TR: MIC94040, -40°C to +125°C Temperature Range, 4-Lead FDFN, 5,000/Reel
	MIC94041:	28 mΩ R _{DS(ON)} 3A High-Side Load Switch with Fast Turn-On and Load Discharge		b) MIC94041YFL-TR: MIC94041, -40°C to +125°C Temperature Range, 4-Lead FDFN, 5,000/Reel
	MIC94042:	28 mΩ R _{DS(ON)} 3A High-Side Load Switch with Soft-Start		c) MIC94042YFL-TR: MIC94042, -40°C to +125°C Temperature Range, 4-Lead FDFN, 5,000/Reel
	MIC94043:	28 mΩ R _{DS(ON)} 3A High-Side Load Switch with Soft-Start and Load Discharge		d) MIC94043YFL-TR: MIC94043, -40°C to +125°C Temperature Range, 4-Lead FDFN, 5,000/Reel
Junction Temperature Range:	Y =	-40°C to +125°C, RoHS-Compliant		Note 1: Tape and Reel identifier only appears in the catalog part number description. This identifier is used for ordering purposes and is not printed on the device package. Check with your Microchip Sales Office for package availability with the Tape and Reel option.
Package:	FL =	4-Lead 1.2 mm x 1.2 mm FDFN		
Media Type:	TR =	5,000/Reel		

MIC94040/1/2/3

NOTES:

Note the following details of the code protection feature on Microchip products:

- Microchip products meet the specifications contained in their particular Microchip Data Sheet.
- Microchip believes that its family of products is secure when used in the intended manner, within operating specifications, and under normal conditions.
- Microchip values and aggressively protects its intellectual property rights. Attempts to breach the code protection features of Microchip product is strictly prohibited and may violate the Digital Millennium Copyright Act.
- Neither Microchip nor any other semiconductor manufacturer can guarantee the security of its code. Code protection does not mean that we are guaranteeing the product is “unbreakable”. Code protection is constantly evolving. Microchip is committed to continuously improving the code protection features of our products.

This publication and the information herein may be used only with Microchip products, including to design, test, and integrate Microchip products with your application. Use of this information in any other manner violates these terms. Information regarding device applications is provided only for your convenience and may be superseded by updates. It is your responsibility to ensure that your application meets with your specifications. Contact your local Microchip sales office for additional support or, obtain additional support at <https://www.microchip.com/en-us/support/design-help/client-support-services>.

THIS INFORMATION IS PROVIDED BY MICROCHIP "AS IS". MICROCHIP MAKES NO REPRESENTATIONS OR WARRANTIES OF ANY KIND WHETHER EXPRESS OR IMPLIED, WRITTEN OR ORAL, STATUTORY OR OTHERWISE, RELATED TO THE INFORMATION INCLUDING BUT NOT LIMITED TO ANY IMPLIED WARRANTIES OF NON-INFRINGEMENT, MERCHANTABILITY, AND FITNESS FOR A PARTICULAR PURPOSE, OR WARRANTIES RELATED TO ITS CONDITION, QUALITY, OR PERFORMANCE.

IN NO EVENT WILL MICROCHIP BE LIABLE FOR ANY INDIRECT, SPECIAL, PUNITIVE, INCIDENTAL, OR CONSEQUENTIAL LOSS, DAMAGE, COST, OR EXPENSE OF ANY KIND WHATSOEVER RELATED TO THE INFORMATION OR ITS USE, HOWEVER CAUSED, EVEN IF MICROCHIP HAS BEEN ADVISED OF THE POSSIBILITY OR THE DAMAGES ARE FORESEEABLE. TO THE FULLEST EXTENT ALLOWED BY LAW, MICROCHIP'S TOTAL LIABILITY ON ALL CLAIMS IN ANY WAY RELATED TO THE INFORMATION OR ITS USE WILL NOT EXCEED THE AMOUNT OF FEES, IF ANY, THAT YOU HAVE PAID DIRECTLY TO MICROCHIP FOR THE INFORMATION.

Use of Microchip devices in life support and/or safety applications is entirely at the buyer's risk, and the buyer agrees to defend, indemnify and hold harmless Microchip from any and all damages, claims, suits, or expenses resulting from such use. No licenses are conveyed, implicitly or otherwise, under any Microchip intellectual property rights unless otherwise stated.

For information regarding Microchip's Quality Management Systems, please visit www.microchip.com/quality.

Trademarks

The Microchip name and logo, the Microchip logo, Adaptec, AnyRate, AVR, AVR logo, AVR Freaks, BesTime, BitCloud, CryptoMemory, CryptoRF, dsPIC, flexPWR, HELDO, IGLOO, JukeBlox, KeeLoq, Klear, LANCheck, LinkMD, maXStylus, maXTouch, MediaLB, megaAVR, Microsemi, Microsemi logo, MOST, MOST logo, MPLAB, OptoLyzer, PIC, picoPower, PICSTART, PIC32 logo, PolarFire, Prochip Designer, QTouch, SAM-BA, SenGenuity, SpyNIC, SST, SST Logo, SuperFlash, Symmetricom, SyncServer, Tachyon, TimeSource, tinyAVR, UNI/O, Vectron, and XMEGA are registered trademarks of Microchip Technology Incorporated in the U.S.A. and other countries.

AgileSwitch, APT, ClockWorks, The Embedded Control Solutions Company, EtherSynch, Flashtec, Hyper Speed Control, HyperLight Load, IntelliMOS, Libero, motorBench, mTouch, Powermite 3, Precision Edge, ProASIC, ProASIC Plus, ProASIC Plus logo, QuietWire, SmartFusion, SyncWorld, Temux, TimeCesium, TimeHub, TimePictra, TimeProvider, TrueTime, WinPath, and ZL are registered trademarks of Microchip Technology Incorporated in the U.S.A.

Adjacent Key Suppression, AKS, Analog-for-the-Digital Age, Any Capacitor, AnyIn, AnyOut, Augmented Switching, BlueSky, BodyCom, CodeGuard, CryptoAuthentication, CryptoAutomotive, CryptoCompanion, CryptoController, dsPICDEM, dsPICDEM.net, Dynamic Average Matching, DAM, ECAN, Espresso T1S, EtherGREEN, GridTime, IdealBridge, In-Circuit Serial Programming, ICSP, INICnet, Intelligent Paralleling, Inter-Chip Connectivity, JitterBlocker, Knob-on-Display, maxCrypto, maxView, memBrain, Mindi, MiWi, MPASM, MPF, MPLAB Certified logo, MPLIB, MPLINK, MultiTRAK, NetDetach, NVM Express, NVMe, Omniscient Code Generation, PICDEM, PICDEM.net, PICkit, PICtail, PowerSmart, PureSilicon, QMatrix, REAL ICE, Ripple Blocker, RTAX, RTG4, SAM-ICE, Serial Quad I/O, simpleMAP, SimpliPHY, SmartBuffer, SmartHLS, SMART-I.S., storClad, SQI, SuperSwitcher, SuperSwitcher II, Switchtec, SynchroPHY, Total Endurance, TSHARC, USBCheck, VariSense, VectorBlox, VeriPHY, ViewSpan, WiperLock, XpressConnect, and ZENA are trademarks of Microchip Technology Incorporated in the U.S.A. and other countries.

SQTP is a service mark of Microchip Technology Incorporated in the U.S.A.

The Adaptec logo, Frequency on Demand, Silicon Storage Technology, Symmcom, and Trusted Time are registered trademarks of Microchip Technology Inc. in other countries.

GestIC is a registered trademark of Microchip Technology Germany II GmbH & Co. KG, a subsidiary of Microchip Technology Inc., in other countries.

All other trademarks mentioned herein are property of their respective companies.

© 2021, Microchip Technology Incorporated and its subsidiaries.

All Rights Reserved.

ISBN: 978-1-5224-9229-0



MICROCHIP

Worldwide Sales and Service

AMERICAS

Corporate Office
2355 West Chandler Blvd.
Chandler, AZ 85224-6199
Tel: 480-792-7200
Fax: 480-792-7277
Technical Support:
<http://www.microchip.com/support>
Web Address:
www.microchip.com

Atlanta

Duluth, GA
Tel: 678-957-9614
Fax: 678-957-1455

Austin, TX

Tel: 512-257-3370

Boston

Westborough, MA
Tel: 774-760-0087
Fax: 774-760-0088

Chicago

Itasca, IL
Tel: 630-285-0071
Fax: 630-285-0075

Dallas

Addison, TX
Tel: 972-818-7423
Fax: 972-818-2924

Detroit

Novi, MI
Tel: 248-848-4000

Houston, TX

Tel: 281-894-5983

Indianapolis

Noblesville, IN
Tel: 317-773-8323
Fax: 317-773-5453
Tel: 317-536-2380

Los Angeles

Mission Viejo, CA
Tel: 949-462-9523
Fax: 949-462-9608
Tel: 951-273-7800

Raleigh, NC

Tel: 919-844-7510

New York, NY

Tel: 631-435-6000

San Jose, CA

Tel: 408-735-9110
Tel: 408-436-4270

Canada - Toronto

Tel: 905-695-1980
Fax: 905-695-2078

ASIA/PACIFIC

Australia - Sydney
Tel: 61-2-9868-6733

China - Beijing
Tel: 86-10-8569-7000

China - Chengdu
Tel: 86-28-8665-5511

China - Chongqing
Tel: 86-23-8980-9588

China - Dongguan
Tel: 86-769-8702-9880

China - Guangzhou
Tel: 86-20-8755-8029

China - Hangzhou
Tel: 86-571-8792-8115

China - Hong Kong SAR
Tel: 852-2943-5100

China - Nanjing
Tel: 86-25-8473-2460

China - Qingdao
Tel: 86-532-8502-7355

China - Shanghai
Tel: 86-21-3326-8000

China - Shenyang
Tel: 86-24-2334-2829

China - Shenzhen
Tel: 86-755-8864-2200

China - Suzhou
Tel: 86-186-6233-1526

China - Wuhan
Tel: 86-27-5980-5300

China - Xian
Tel: 86-29-8833-7252

China - Xiamen
Tel: 86-592-2388138

China - Zhuhai
Tel: 86-756-3210040

ASIA/PACIFIC

India - Bangalore
Tel: 91-80-3090-4444

India - New Delhi
Tel: 91-11-4160-8631

India - Pune
Tel: 91-20-4121-0141

Japan - Osaka
Tel: 81-6-6152-7160

Japan - Tokyo
Tel: 81-3-6880-3770

Korea - Daegu
Tel: 82-53-744-4301

Korea - Seoul
Tel: 82-2-554-7200

Malaysia - Kuala Lumpur
Tel: 60-3-7651-7906

Malaysia - Penang
Tel: 60-4-227-8870

Philippines - Manila
Tel: 63-2-634-9065

Singapore
Tel: 65-6334-8870

Taiwan - Hsin Chu
Tel: 886-3-577-8366

Taiwan - Kaohsiung
Tel: 886-7-213-7830

Taiwan - Taipei
Tel: 886-2-2508-8600

Thailand - Bangkok
Tel: 66-2-694-1351

Vietnam - Ho Chi Minh
Tel: 84-28-5448-2100

EUROPE

Austria - Wels
Tel: 43-7242-2244-39
Fax: 43-7242-2244-393

Denmark - Copenhagen
Tel: 45-4485-5910
Fax: 45-4485-2829

Finland - Espoo
Tel: 358-9-4520-820

France - Paris
Tel: 33-1-69-53-63-20
Fax: 33-1-69-30-90-79

Germany - Garching
Tel: 49-8931-9700

Germany - Haan
Tel: 49-2129-3766400

Germany - Heilbronn
Tel: 49-7131-72400

Germany - Karlsruhe
Tel: 49-721-625370

Germany - Munich
Tel: 49-89-627-144-0
Fax: 49-89-627-144-44

Germany - Rosenheim
Tel: 49-8031-354-560

Israel - Ra'anana
Tel: 972-9-744-7705

Italy - Milan
Tel: 39-0331-742611
Fax: 39-0331-466781

Italy - Padova
Tel: 39-049-7625286

Netherlands - Drunen
Tel: 31-416-690399
Fax: 31-416-690340

Norway - Trondheim
Tel: 47-7288-4388

Poland - Warsaw
Tel: 48-22-3325737

Romania - Bucharest
Tel: 40-21-407-87-50

Spain - Madrid
Tel: 34-91-708-08-90
Fax: 34-91-708-08-91

Sweden - Gothenberg
Tel: 46-31-704-60-40

Sweden - Stockholm
Tel: 46-8-5090-4654

UK - Wokingham
Tel: 44-118-921-5800
Fax: 44-118-921-5820