

DATA SHEET

SUNGMUN CODE : QDR-08S
DESCRIPTION : ROTARY DIP SWITCH

SUNGMUN ELECTRONICS CO., LTD.

Address 301-302, Bucheon Technopark 345, Seokcheon-ro, Ojeong-gu
Bucheon-si, Gyeonggi-do, Korea
TEL. +82-32-328-1941~4
FAX +82-32-328-1945
E-mail sungmun@sungmun.co.kr
Website www.sungmun.com



SUNGMUN
ELECTRONICS

MRK. 	DATE	REVISION	SIGN
--	------	----------	------

SPECIFICATION

1. Rating : 150mA, DC 42V (Switching)
200mA, DC 42V (None-Switching)
2. Contact Resistance : 80mΩ Max
3. Insulation Resistance : 100MΩ Min at DC 250V
4. Operating Force : 700gf Max
5. Life cycle : 10,000 steps
6. Sealing : IP67 (Dust & Water proof)
7. Packing : 50pcs Tube / 600pcs Reel Packing

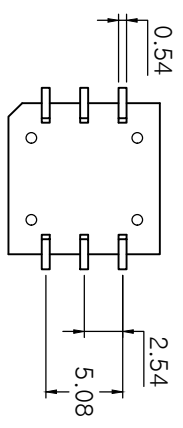
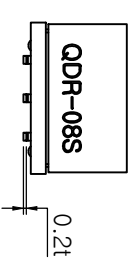
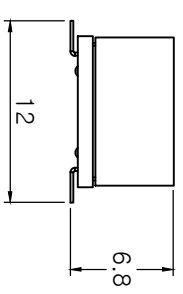
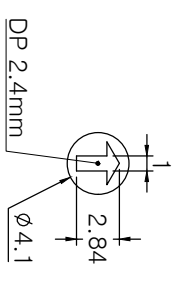
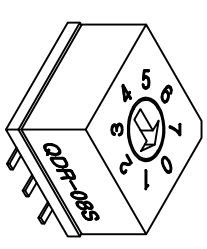
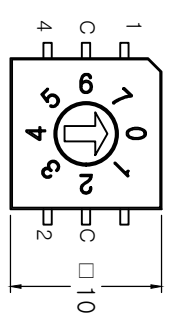
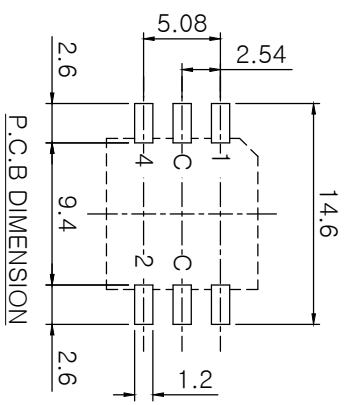

08 P o s i t i o n	Reel Code			
	C	1	2	4
0	●			0
1	●	●		1
2	●		●	2
3	●	●		3
4	●		●	4
5	●	●		5
6	●		●	6
7	●	●		7

DRAW/DESIGNED	CHECKED	APPROVED		G.TOL	TITLE
J.S YANG	W.J LEE	K.L LEE		±0.3	ROTARY DIP SWITCH
2022-01-25	2022-01-25	2022-01-25	UNIT	SCALE	MODEL
			mm	2:1	QDR-08S
			SIZE	DRAW	REV.
			A4	NO.	03
SUNGMUN ELECTRONICS CO.,LTD					QDR-08S-03

1. Description:

This specification describes "10X10 size of Rotary Dip Switches" which are S, T, F and Q,E series.

1-1 Operating / Storage Temperature Range : -40°C ~ +85°C

2. Rating:

2-1 None-Switching : 200 mA, DC 42V

2-2 Switching : 150 mA, DC 42V

3. Type of Actuation : Rotating

4. Electrical Characteristics

ITEM	DESCRIPTION	TEST CONDITIONS	REQUIREMENTS
4-1	Visual Examination	By visual examination check without any out pressure & testing.	There shall be no defects that affect the serviceability of the product.
4-2	Contact Resistance	① To be measured between the two terminals associated with each switch pole. ② Measurements shall be made with a 1kHz shall current contact resistance meter.	80mΩ max.
4-3	Insulation Resistance	250V DC, 1minute ±5seconds	100 MΩ min.
4-4	Dielectric withstanding Voltage	250V AC(50Hz or 60Hz)shall be applied between all the adjacent terminal and between the terminal and the frame for 1 minute.	There shall be no breakdown or flashover.

5. Mechanical Characteristics

ITEM	DESCRIPTION	TEST CONDITIONS	REQUIREMENTS
5-1	Operation Force	Operating direction shall be clockwise or counter clockwise direction	700gf·cm max
5-2	Operation Life	Measurements shall be made following the test set forth below: 1)150mA, 42V DC resistive load 2)Rate of operation: 15~20 cycles/ minute 3)Step of operation: 10,000 steps	1)As shown in item 4-3, 4-4 2)Contact Resistance: 200mΩ max

6. Environmental Characteristics

ITEM	DESCRIPTION	TEST CONDITIONS	REQUIREMENTS
6-1	Resistance Low Temperature	Following the test set forth below the sample shall be left in normal temperature and humidity conditions for an hour before measurements are made: 1)Temperature: -40°C ±3°C 2)Time: 96 hours	1)As shown in item 4-3, 4-4, 5-1 2)Contact Resistance: 200mΩ max
6-2	Resistance High Temperature	Following the test set forth below the sample shall be left in normal temperature and humidity conditions for an hour before measurements are made: 1)Temperature: 85°C ±2°C 2)Time: 96 hours	1)As shown in item 4-3, 4-4, 5-1 2)Contact Resistance: 200mΩ max
6-3	Resistance Humidity	Following the test set forth below the sample shall be left in normal temperature and humidity conditions for an hour before measurements are made: 1)Temperature: 40°C ±2°C 2)Relative humidity: 90~95% 3)Time: 96 hours	1)As shown in item 4-4, 5-1 2)Contact Resistance: 200mΩ max 3)Insulation Resistance: 10 MΩ min

7. This item is "RoHS" Compliant

8. Manual Soldering : Max 350°C, 3 sec.

9. Wave Soldering : Max 260°C, 5 sec.

10. Reflow Soldering Conditions: (SMD type only)



10-1 Condition for Soldering

Profile Feature	Pb-Free Assembly
Average Ramp-UP Rate(Ts max to TP)	3°C/second max
Preheat	
- Temperature Min(Ts min)	150°C
- Temperature Max(Ts max)	200°C
- Time (ts min to ts max)	60-180seconds
Time maintained above:	
- Temperature (TL)	217°C
- Time (tL)	60-150seconds
Peak/Classification Temperature(TP)	260°C +0°C/ -5°C
Time within 5°C of actual Peak Temperature(TP)	5~10 seconds
Ramp-Down Rate	6°C/sec max
Time 25°C to Peak Temperature	8 minutes max