

8.0 A Single-Phase Silicon Bridge Rectifier
Rectifier Reverse Voltage 50 to 1000V

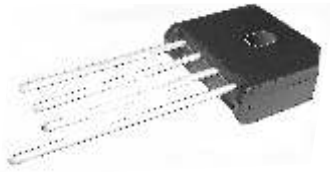

Features

- Ideal for P.C. Board mounting
- High surge current capability
- This series is UL listed under the Recognized Component Index, file number E142814
- The plastic material used carries Underwriters Laboratory flammability recognition 94V-0
- High temperature soldering guaranteed 265°C /10 seconds at 5 lbs (2.3kg) tension

Mechanical Data

Case: Molded plastic body
 Terminals: Plated leads solderable per MIL-STD-202, Method 208
 Polarity: Polarity symbols molded on body
 Mounting Position:: Any
 Mounting Torque: 5 in-lbs max.
 Weight: 0.3 ounce, 8.0 grams (approx)

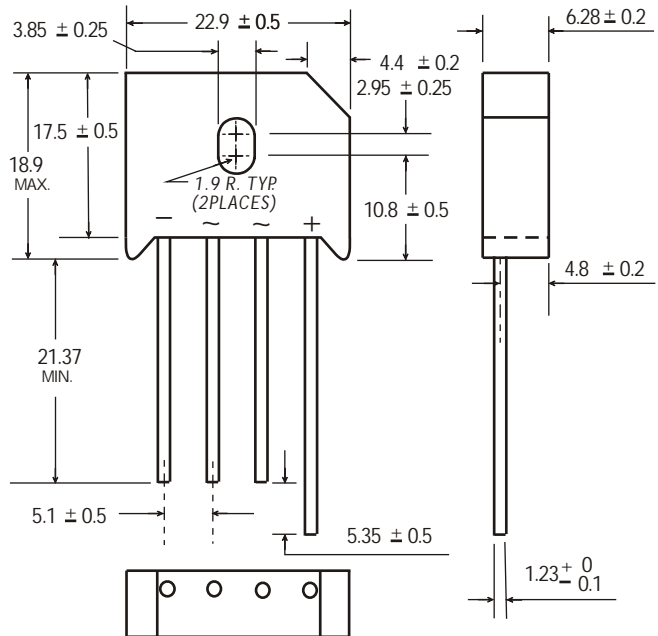

Dimensions in millimeters(1mm =0.0394")

Maximum Ratings & Thermal Characteristics

Rating at 25°C ambient temperature unless otherwise specified, Resistive or Inductive load, 60 Hz.
 For Capacitive load derate current by 20%.

Parameter	Symbol	KBU 8005	KBU 801	KBU 802	KBU 804	KBU 806	KBU 808	KBU 810	unit
Maximum repetitive peak reverse voltage	VRRM	50	100	200	400	600	700	1000	V
Maximum RMS bridge input voltage	VRMS	35	70	140	280	420	560	700	V
Maximum DC blocking voltage	VDC	50	100	200	400	600	700	1000	V
Maximum average forward rectified output current at TA=100°C	IF(AV)	8.0							A
Peak forward surge current single sine-wave superimposed on rated load (JEDEC Method)	IFSM	300							A
Rating for fusing (t<8.3ms)	I ² t	150							A ² sec
Typical thermal resistance per element (1)	ReJA	2.7							°C / W
Operating junction and storage temperature range	TJ, TSTG	-55 to + 150							°C

Electrical Characteristics

Rating at 25°C ambient temperature unless otherwise specified. Resistive or Inductive load, 60Hz.
 For Capacitive load derate by 20 %.

Parameter	Symbol	KBU 8005	KBU 801	KBU 802	KBU 804	KBU 806	KBU 807	KBU 810	Unit
Maximum instantaneous forward voltage drop per leg at 8.0A	VF	1.1							V
Maximum DC reverse current at rated DC blocking voltage per element	IR	10 500							μA

Notes: (1)Thermal resistance from Junction to Ambient on P.C.board mounting.

Rating and Characteristic Curves ($T_A=25^{\circ}\text{C}$ Unless otherwise noted) KBU8005 thru KBU810

Fig. 1 Derating Curve for Output Rectified Current

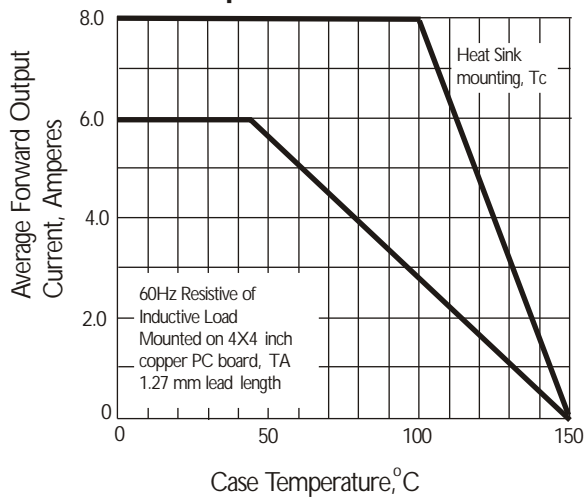

Fig. 2 Maximum Non-repetitive Peak Forward Surge Current

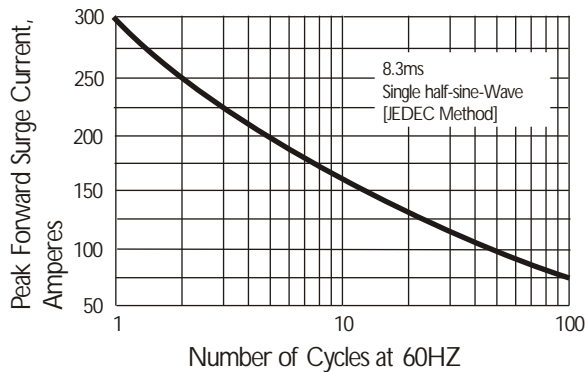

Fig. 3 Typical Instantaneous Forward Characteristics

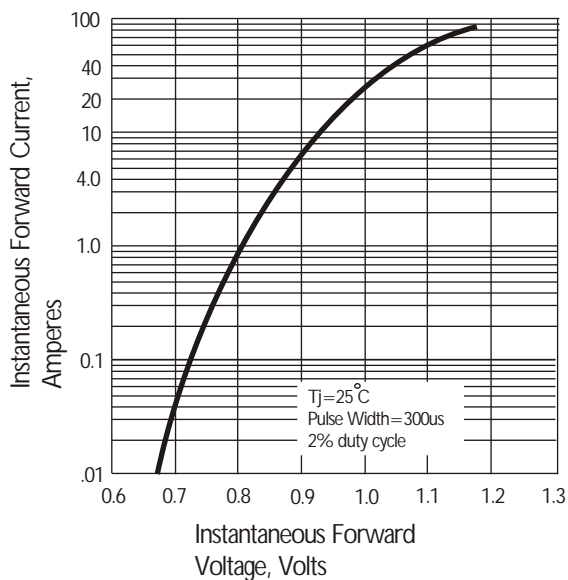

Fig. 4 Typical Reverse Characteristics

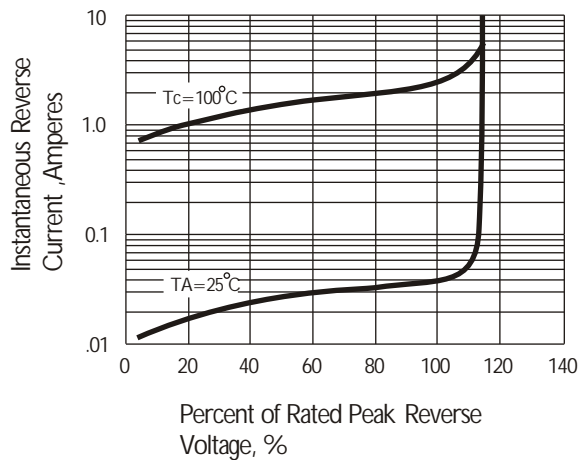

Fig. 5 Typical Junction Capacitance

