

»Features

- Excellent clamping capability
- Low leakage current
- Low capacitance
- High surge capability
- Glass passivated chip
- Epoxy resin package
- Built-in strain relief
- Will not fatigue
- RoHS Compliant
- Fast response time:
typically less than 1.0ps from 0 Volts to V_{BR} min



SOD-123F

»Mechanical Characteristics

- Package: SOD-123F plastic package.
- Lead Finish: Matte Tin
- Case Material: Epoxy Molding Compound.
- UL Flammability Classification Rating 94V-0
- Moisture Sensitivity: Level 1 per J-STD-020

»Applications

- Cellular phones
- Portable devices
- Business machines
- Power supplies
- Consumer applications

»Electrical Parameters

Parameter	Definition
C_J	Junction Capacitance - typical capacitance measured with 0V or V_R bias
I_{PP}	Peak Pulse Current - maximum rated peak impulse current
V_C	Clamping Voltage - Peak voltage measured across the suppressor at a specified I_{ppm} (peak impulse current)
V_{BR}	Breakdown Voltage - Maximum voltage that flows through the TVS at a specified test current (I_T)
I_R	Leakage Current - maximum peak off-state current measured at V_R
V_R	Peak Off-state Voltage - maximum voltage that can be applied while maintaining off state

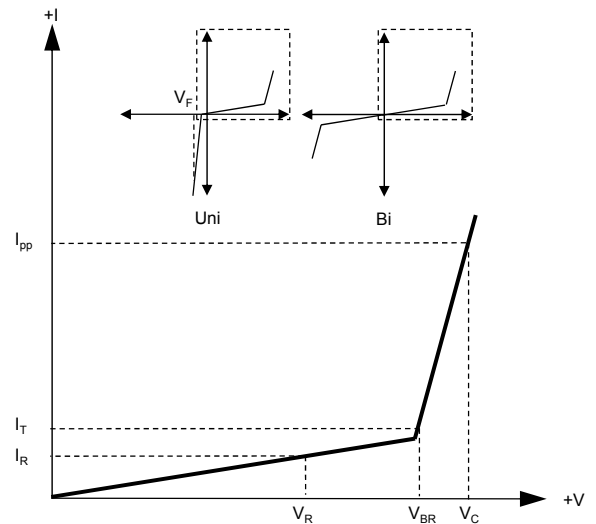

»Summary of Packing Options

Package	Packing Description	Packing Quantity	Industry Standard
SOD-123F	Tape/Reel, 7" reel	3000	EIA-481-1
	Tape/Reel, 13" reel	10000	EIA-481-1

»Absolute Maximum Ratings ($T_A=25^{\circ}\text{C}$ unless otherwise noted)

Parameter	Symbol	Value	Units	Remarks
Peak Pulse Power Dissipation	P_{PPM}	200	W	(Note1)(Note2)
Steady State Power Dissipation	P_D	1	W	(Note3)
Peak Forward Surge Current	I_{FSM}	20	A	(Note4)
Maximum Instantaneous Forward Voltage at 10A	V_{FM}	3.5	V	(Note5)
Typical Thermal Resistance Junction to Lead	$R_{\theta JL}$	100	$^{\circ}\text{C}/\text{W}$	
Typical Thermal Resistance Junction to Ambient	$R_{\theta JA}$	220	$^{\circ}\text{C}/\text{W}$	
Operating Temperature Range	T_J	-55 to 150	$^{\circ}\text{C}$	
Storage Temperature Range	T_{STG}	-55 to 150	$^{\circ}\text{C}$	

Notes1: Non-repetitive current pulse , 10/1000us Waveform.

Notes2: Mounted on copper pad area of 3×3mm to each terminal.

Notes3: Infinite HeatSink at $T_A=50^{\circ}\text{C}$

Notes4: Measured on 8.3ms single half sine wave or equivalent square wave, duty cycle=4 perminute maximum.

Notes5: For UnidirectionalOnly.

»Electrical Characteristics ($T_A=25^{\circ}\text{C}$ unless otherwise noted)

Part Number (Uni)	Part Number (Bi)	Reverse Stand off Voltage V_R (V)	Breakdown Voltage $V_{BR} @ I_T$ (V)		Test Current I_T (mA)	Maximum Clamping Voltage $V_C @ I_{PP}$ (V)	Maximum Peak Pulse Current I_{PP} (A)	Maximun Reverse Leakage $I_R @ V_R$ (μA)
			Min	Max				
SMFJ5.0A	SMFJ5.0CA	5	6.4	7	10	9.2	21.7	400
SMFJ6.0A	SMFJ6.0CA	6	6.67	7.37	10	10.3	19.4	400
SMFJ6.5A	SMFJ6.5CA	6.5	7.22	7.98	10	11.2	17.9	250
SMFJ7.0A	SMFJ7.0CA	7	7.78	8.6	10	12	16.7	100
SMFJ7.5A	SMFJ7.5CA	7.5	8.33	9.21	1	12.9	15.5	50
SMFJ8.0A	SMFJ8.0CA	8	8.89	9.83	1	13.6	14.7	25
SMFJ8.5A	SMFJ8.5CA	8.5	9.44	10.4	1	14.4	13.9	10
SMFJ9.0A	SMFJ9.0CA	9	10	11.1	1	15.4	13	5
SMFJ10A	SMFJ10CA	10	11.1	12.3	1	17	11.8	2.5
SMFJ11A	SMFJ11CA	11	12.2	13.5	1	18.2	11	2.5
SMFJ12A	SMFJ12CA	12	13.3	14.7	1	19.9	10.1	2.5
SMFJ13A	SMFJ13CA	13	14.4	15.9	1	21.5	9.3	1
SMFJ14A	SMFJ14CA	14	15.6	17.2	1	23.2	8.6	1
SMFJ15A	SMFJ15CA	15	16.7	18.5	1	24.4	8.2	1
SMFJ16A	SMFJ16CA	16	17.8	19.7	1	26	7.7	1
SMFJ17A	SMFJ17CA	17	18.9	20.9	1	27.6	7.2	1
SMFJ18A	SMFJ18CA	18	20	22.1	1	29.2	6.8	1
SMFJ20A	SMFJ20CA	20	22.2	24.5	1	32.4	6.2	1
SMFJ22A	SMFJ22CA	22	24.4	26.9	1	35.5	5.6	1
SMFJ24A	SMFJ24CA	24	26.7	29.5	1	38.9	5.1	1

»Electrical Characteristics ($T_A=25^{\circ}\text{C}$ unless otherwise noted)

Part Number (Uni)	Part Number (Bi)	Reverse Stand off Voltage V_R (V)	Breakdown Voltage $V_{BR} @ I_T$ (V)		Test Current I_T (mA)	Maximum Clamping Voltage $V_C @ I_{PP}$ (V)	Maximum Peak Pulse Current I_{PP} (A)	Maximum Reverse Leakage $I_R @ V_R$ (μA)
			Min	Max				
SMFJ26A	SMFJ26CA	26	28.9	31.9	1	42.1	4.8	1
SMFJ28A	SMFJ28CA	28	31.1	34.4	1	45.4	4.4	1
SMFJ30A	SMFJ30CA	30	33.3	36.8	1	48.4	4.1	1
SMFJ33A	SMFJ33CA	33	36.7	40.6	1	53.3	3.8	1
SMFJ36A	SMFJ36CA	36	40	44.2	1	58.1	3.4	1
SMFJ40A	SMFJ40CA	40	44.4	49.1	1	64.5	3.1	1
SMFJ43A	SMFJ43CA	43	47.8	52.8	1	69.4	2.9	1
SMFJ45A	SMFJ45CA	45	50	55.3	1	72.7	2.8	1
SMFJ48A	SMFJ48CA	48	53.3	58.9	1	77.4	2.6	1
SMFJ51A	SMFJ51CA	51	56.7	62.7	1	82.4	2.4	1
SMFJ54A	SMFJ54CA	54	60	66.3	1	87.1	2.3	1
SMFJ58A	SMFJ58CA	58	64.4	71.2	1	93.6	2.1	1
SMFJ60A	SMFJ60CA	60	66.7	73.7	1	96.8	1.8	1
SMFJ64A	SMFJ64CA	64	71.1	78.6	1	103	1.7	1
SMFJ70A	SMFJ70CA	70	77.8	86	1	113	1.5	1
SMFJ75A	SMFJ75CA	75	83.3	92.1	1	121	1.4	1
SMFJ78A	SMFJ78CA	78	86.7	95.8	1	126	1.4	1
SMFJ85A	SMFJ85CA	85	94.4	104	1	137	1.3	1
SMFJ90A	SMFJ90CA	90	100	111	1	146	1.2	1
SMFJ100A	SMFJ100CA	100	111	123	1	162	1.1	1
SMFJ110A	SMFJ110CA	110	122	135	1	177	1	1
SMFJ120A	SMFJ120CA	120	133	147	1	193	0.9	1
SMFJ130A	SMFJ130CA	130	144	159	1	209	0.8	1
SMFJ150A	SMFJ150CA	150	167	185	1	243	0.7	1
SMFJ160A	SMFJ160CA	160	178	197	1	259	0.7	1
SMFJ170A	SMFJ170CA	170	189	209	1	275	0.6	1
SMFJ180A	SMFJ180CA	180	201	222	1	292	0.7	1
SMFJ190A	SMFJ190CA	190	209	243	1	308	0.6	1
SMFJ200A	SMFJ200CA	200	224	247	1	324	0.6	1
SMFJ210A	SMFJ210CA	210	231	268	1	340	0.6	1
SMFJ220A	SMFJ220CA	220	246	272	1	356	0.5	1
SMFJ250A		250	279	309	1	405	0.5	1
SMFJ300A		300	335	371	1	486	0.4	1
SMFJ350A		350	391	432	1	567	0.3	1
SMFJ400A		400	447	494	1	648	0.3	1
SMFJ440A		440	492	543	1	713	0.3	1

»Rating And Characteristic Curves ($T_A=25^\circ\text{C}$ unless otherwise noted)

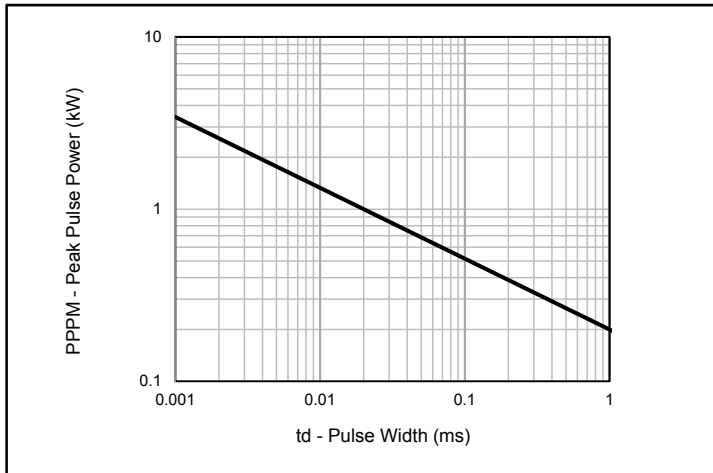

Fig.1 - Peak Pulse Power Rating

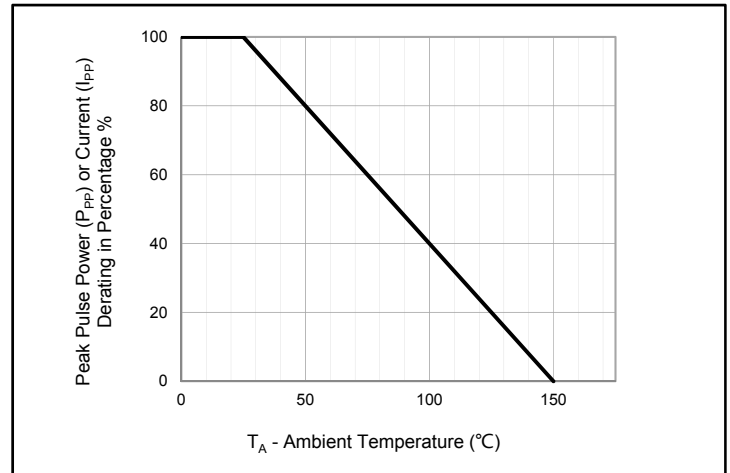

Fig.2 - Pulse Derating Curve

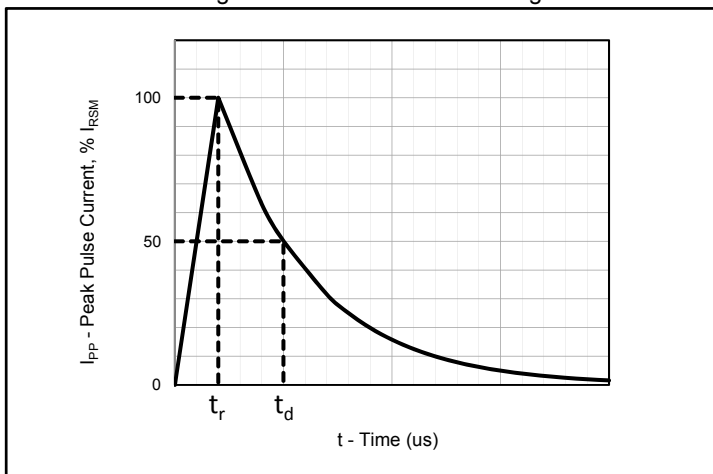

Fig.3 - Pulse Waveform

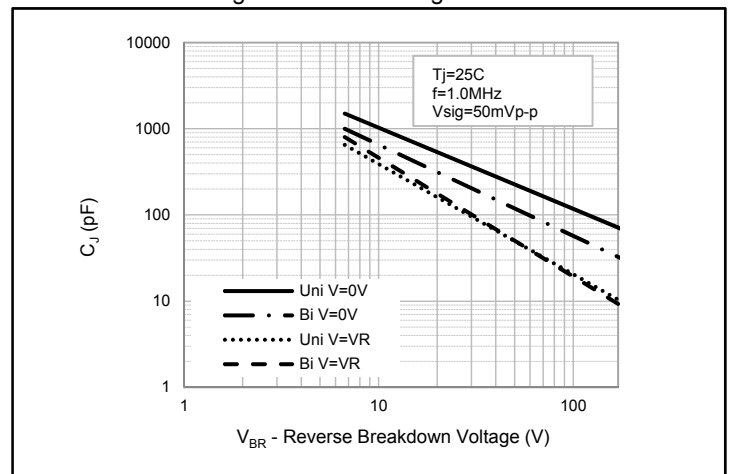

Fig.4 - Typical Junction Capacitance

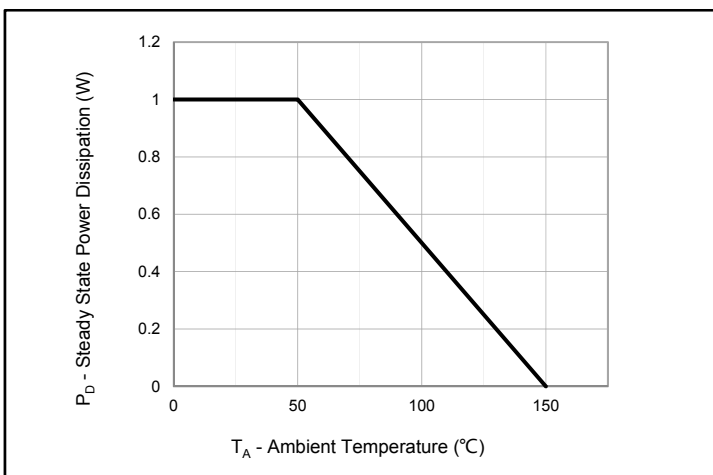

Fig.5 - Steady State Power Dissipation Derating Curve

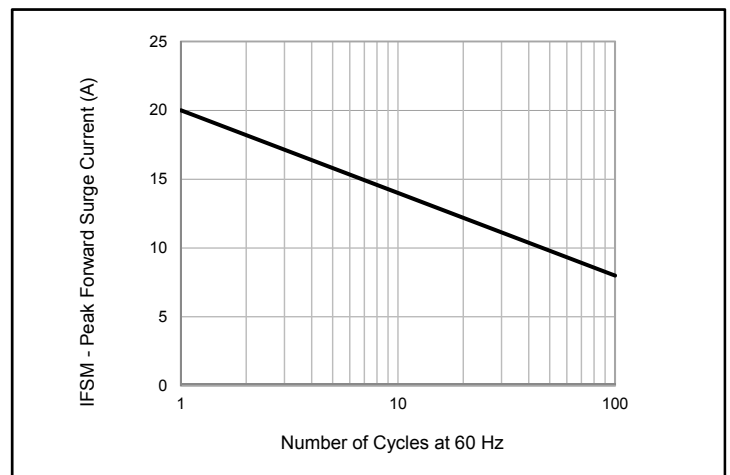
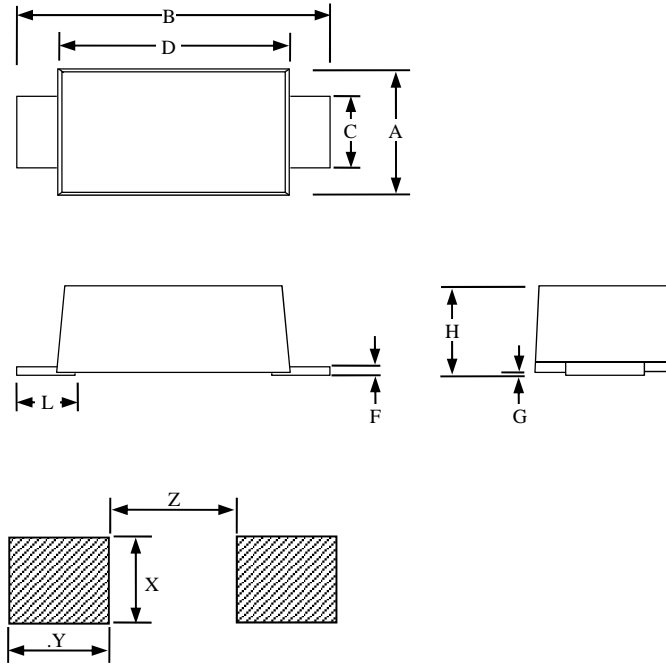

Fig.6 - Maximum Non-Repetitive Peak Forward Surge Current
Uni-Directional Only

»Package Dimensions



SOD-123F						
Dimension	Inches			Millimeters		
	MIN	NOM	MAX	MIN	NOM	MAX
A	0.059		0.079	1.5		2
B	0.134		0.154	3.4		3.9
C	0.028		0.047	0.7		1.2
D	0.098		0.114	2.5		2.9
F	0.002		0.01	0.05		0.26
G	-		0.004	-		0.1
H	0.037		0.053	0.95		1.35
L	0.014		0.035	0.35		0.9
X		0.055			1.4	
Y		0.051			1.3	
Z		0.063			1.6	

»Marking Information

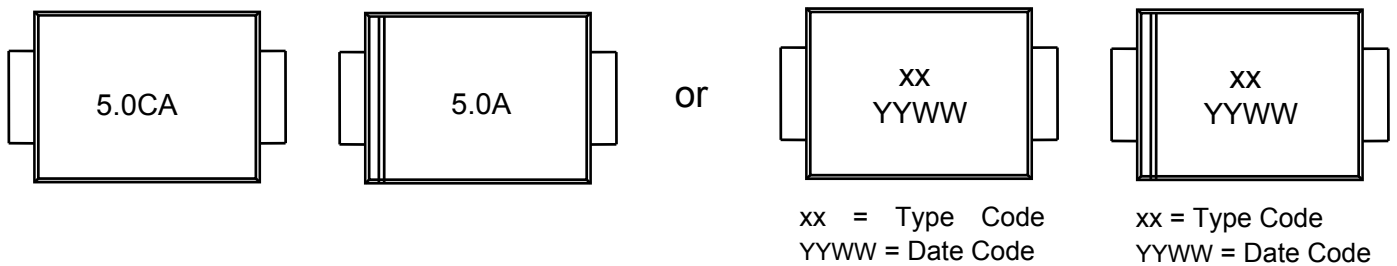

»Soldering Parameters

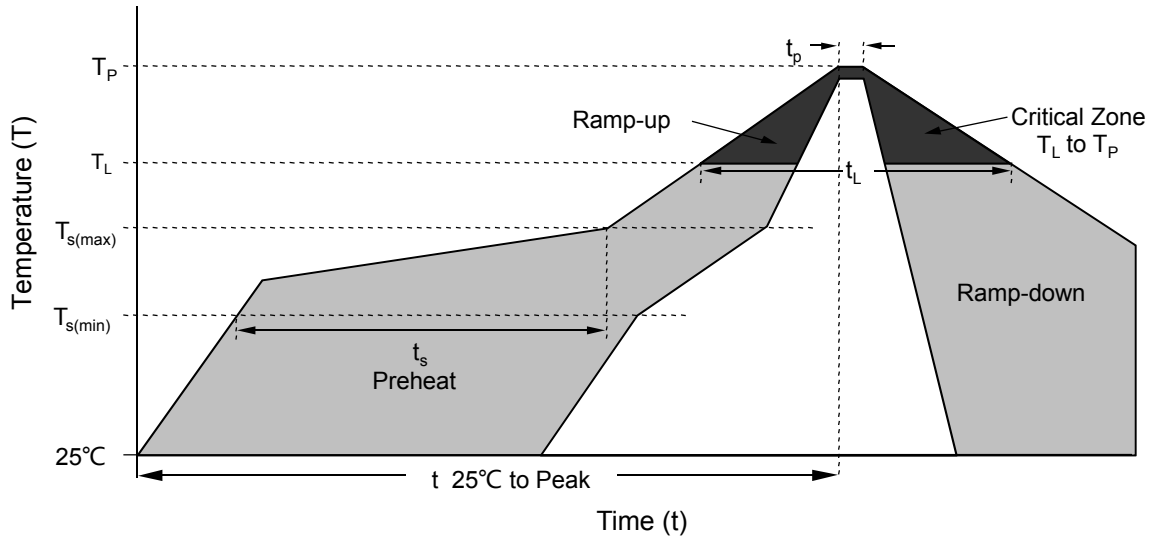

Reflow Condition		Lead-free assembly
Pre Heat	- Temperature Min ($T_{s(min)}$)	150°C
	- Temperature Max ($T_{s(max)}$)	200°C
	- Time (min to max) (t_s)	60 – 180 secs
Average ramp up rate (Liquidus Temp (T_L) to peak)		3°C/second max
$T_{s(max)}$ to T_L - Ramp-up Rate		3°C/second max
Reflow	- Temperature (T_L) (Liquidus)	217°C
	- Time (t_L)	60 – 150 secs
Peak Temperature (T_P)		260 ^{+0/-5} °C
Time within 5°C of actual peak Temperature (t_p)		20 – 40 secs
Ramp-down Rate		6°C/second max
Time 25°C to peak Temperature (t)		8 minutes Max.
Do not exceed		260°C

»Tape and Reel Specification

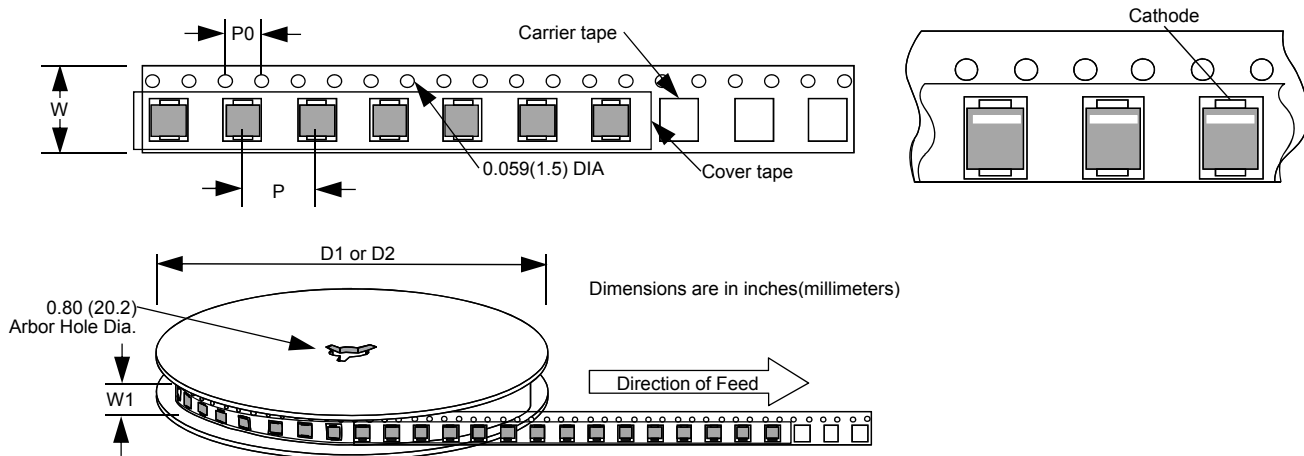

Dimension	Inches			Millimeters		
	MIN	NOM	MAX	MIN	NOM	MAX
P		0.157			4	
P0		0.157			4	
W		0.315			8	
W1		0.374			9.5	
D1		7			177.8	
D2		13			330.2	