

P-CHANNEL MOSFET FOR SWITCHING

RC60P04Y

■ Features

- -60V, -4.0A, $R_{DS(ON)} = 90m\Omega$ @ $V_{GS} = -10V$.
 $R_{DS(ON)} = 125m\Omega$ @ $V_{GS} = -4.5V$.
- High dense cell design for extremely low $R_{DS(ON)}$.
- Rugged and reliable.

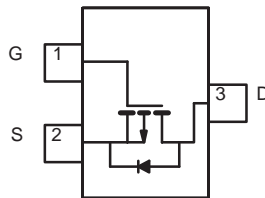

SOT-23L(SC59)

Unit:mm

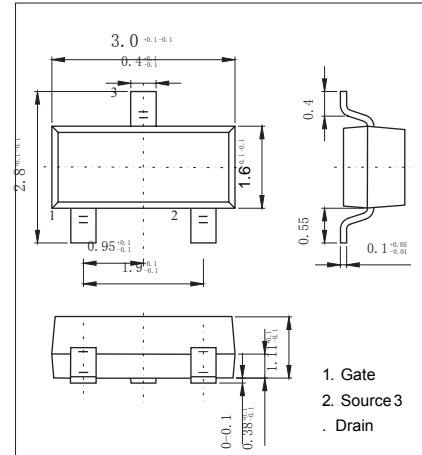

ABSOLUTE MAXIMUM RATINGS $T_A = 25\text{ }^\circ\text{C}$ unless otherwise noted

Parameter	Symbol	Limit	Units
Drain-Source Voltage	V_{DS}	-60	V
Gate-Source Voltage	V_{GS}	± 20	V
Drain Current-Continuous	I_D	-4.0	A
Drain Current-Pulsed ^a	I_{DM}	-17.2	A
Maximum Power Dissipation	P_D	3	W
Operating and Store Temperature Range	T_J, T_{stg}	-55 to 150	$^\circ\text{C}$

Thermal Characteristics

Parameter	Symbol	Limit	Units
Thermal Resistance, Junction-to-Ambient ^b	$R_{\theta JA}$	42	$^\circ\text{C/W}$

■ Marking

Marking	60P04Y
---------	--------

P-CHANNEL MOSFET FOR SWITCHING

RC60P04Y

Electrical Characteristics $T_A = 25\text{ }^\circ\text{C}$ unless otherwise noted

Parameter	Symbol	Test Condition	Min	Typ	Max	Units
Off Characteristics						
Drain-Source Breakdown Voltage	BV_{DSS}	$V_{GS} = 0V, I_D = -250\mu A$	-60			V
Zero Gate Voltage Drain Current	I_{DSS}	$V_{DS} = -60V, V_{GS} = 0V$			-1	μA
Gate Body Leakage Current, Forward	I_{GSSF}	$V_{GS} = 20V, V_{DS} = 0V$			100	nA
Gate Body Leakage Current, Reverse	I_{GSSR}	$V_{GS} = -20V, V_{DS} = 0V$			-100	nA
On Characteristics^c						
Gate Threshold Voltage	$V_{GS(th)}$	$V_{GS} = V_{DS}, I_D = -250\mu A$	-1		-3	V
Static Drain-Source On-Resistance	$R_{DS(on)}$	$V_{GS} = -10V, I_D = -4A$		90	92	$m\Omega$
		$V_{GS} = -4.5V, I_D = -2A$			125	$m\Omega$
Dynamic Characteristics^d						
Input Capacitance	C_{iss}	$V_{DS} = -30V, V_{GS} = 0V, f = 1.0\text{ MHz}$		1135		pF
Output Capacitance	C_{oss}			95		pF
Reverse Transfer Capacitance	C_{rss}			60		pF
Switching Characteristics^d						
Turn-On Delay Time	$t_{d(on)}$	$V_{DD} = -30V, I_D = -1A, V_{GS} = -10V, R_{GEN} = 6\Omega$		13	26	ns
Turn-On Rise Time	t_r			4	8	ns
Turn-Off Delay Time	$t_{d(off)}$			45	90	ns
Turn-On Fall Time	t_f			6	12	ns
Total Gate Charge	Q_g	$V_{DS} = -30V, I_D = -3.5A, V_{GS} = -10V$		22.6	14.3	nC
Gate-Source Charge	Q_{gs}			2.4		nC
Gate-Drain Charge	Q_{gd}			5.7		nC
Drain-Source Diode Characteristics and Maximum Ratings						
Drain-Source Diode Forward Current ^b	I_S				-2.5	A
Drain-Source Diode Forward Voltage ^c	V_{SD}	$V_{GS} = 0V, I_S = -1.3A$			-1.2	V
Notes : □ a.Repetitive Rating : Pulse width limited by maximum junction temperature. □ b.Surface Mounted on FR4 Board, $t \leq 10\text{ sec.}$ □ c.Pulse Test : Pulse Width $\leq 300\mu s$, Duty Cycle $\leq 2\%$. □ d.Guaranteed by design, not subject to production testing. □ □						

P-CHANNEL MOSFET FOR SWITCHING

RC60P04Y

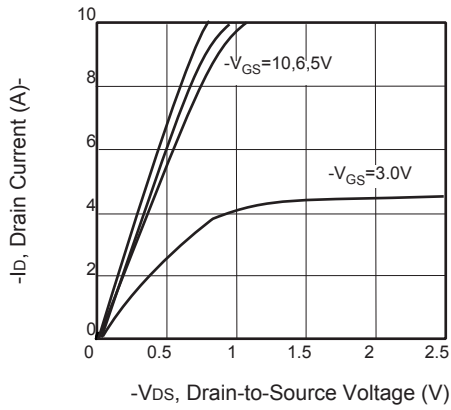

Figure 1. Output Characteristics

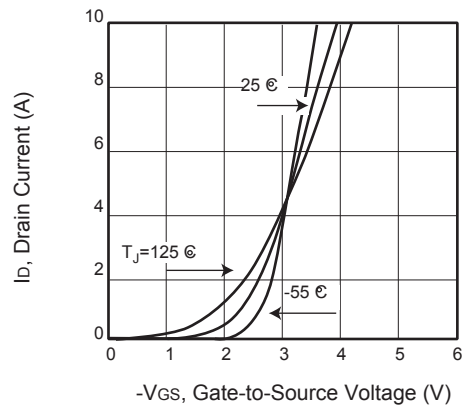

Figure 2. Transfer Characteristics

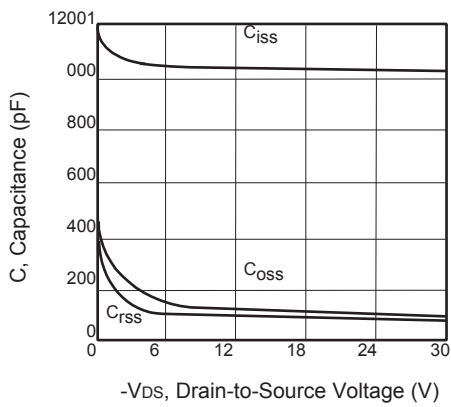

Figure 3. Capacitance

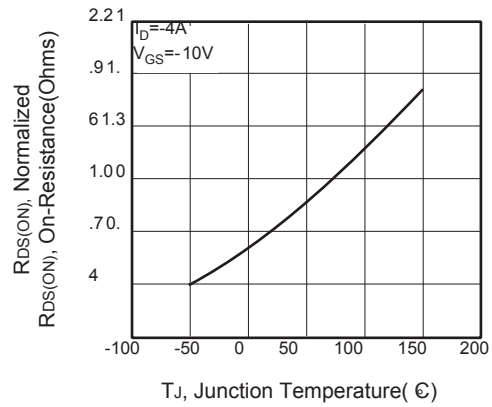

Figure 4. On-Resistance Variation with Temperature

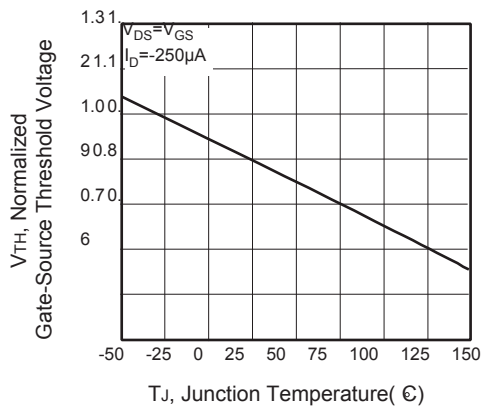

Figure 5. Gate Threshold Variation with Temperature

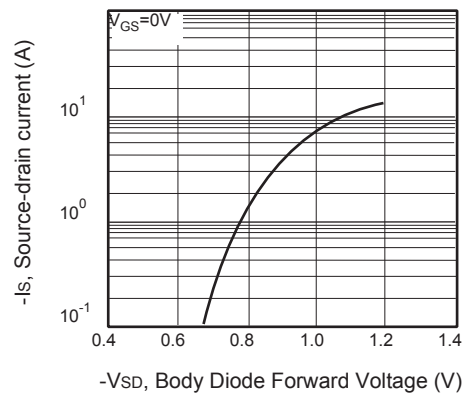

Figure 6. Body Diode Forward Voltage Variation with Source Current

P-CHANNEL MOSFET FOR SWITCHING

RC60P04Y

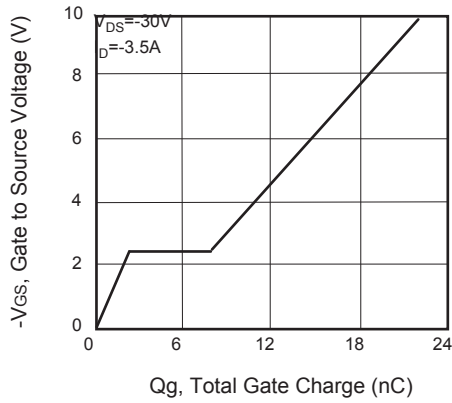

Figure 7. Gate Charge

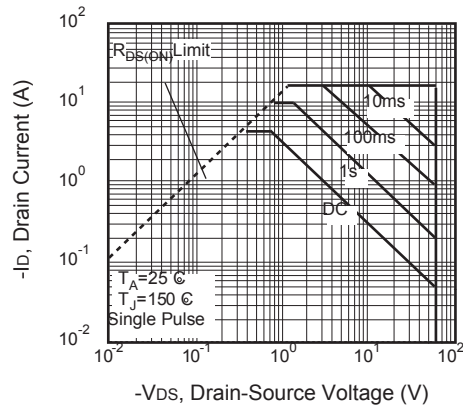

Figure 8. Maximum Safe Operating Area

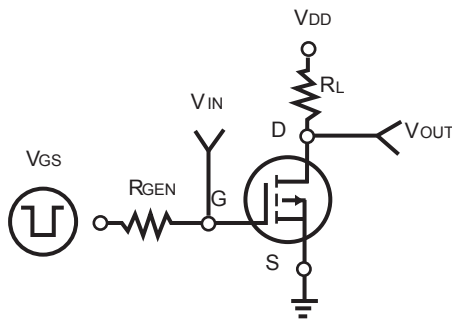

Figure 9. Switching Test Circuit

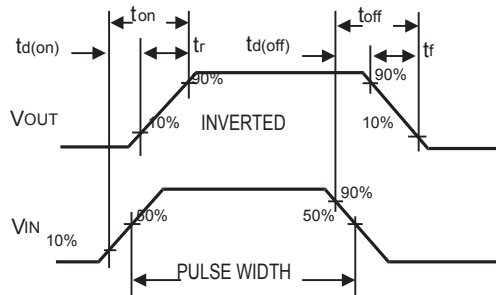

Figure 10. Switching Waveforms

P-CHANNEL MOSFET FOR SWITCHING

RC60P04Y

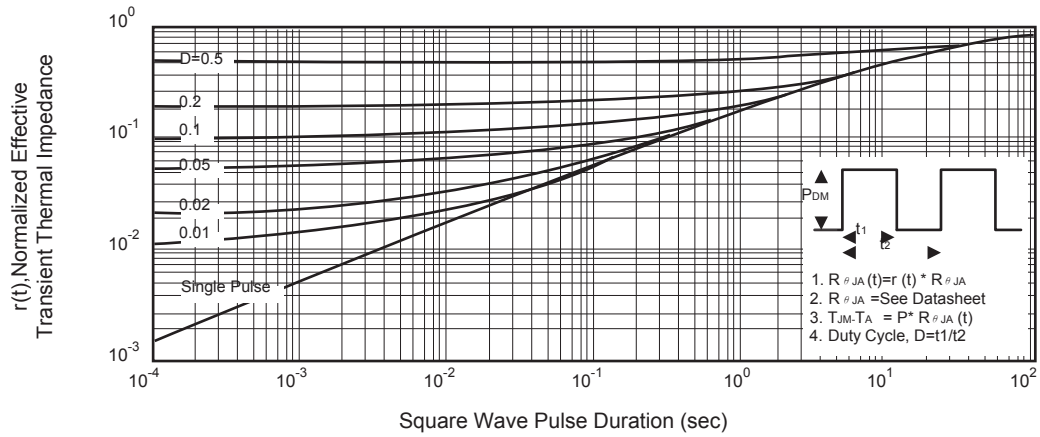

Figure 11. Normalized Thermal Transient Impedance Curve