

Description

RSFD1702N is a high performance duplexer designed for applications in LTE Band3 (1710~1785 MHz TX, 1805~1880 MHz RX).

RSFD1702N is designed with ROFS's Film Bulk Acoustic Resonator (FBAR) technology, which provides high-Q filters and meets requirements of low insertion loss, high return loss decreases loss at Tx port, high out-of-band attenuation.

RSFD1702N uses chip scale packaging (CSP) technology to assembly the filters into a molded chip-on-board module with the footprint of 1.6mm x 1.2mm and height of 0.6mm.

Features

- Miniature Size
1.6 mm x 1.2 mm x 0.6 mm
- Insertion Loss:
 - Tx 2.1dB Typ.
 - Rx 2.6dB Typ.
- Tx-RX Isolation:
 - Tx Pass Band 55dB Typ.
 - Rx Pass Band 56dB Typ.
- Tx Input Power
 - +29dBm CW 55°C 5000hours
- ESD protection ability: HBM Class 1C
- Moisture Sensitivity: MSL3
- Storage Temperature: -40 to +85 °C

Environmental

- Full implement with RoHS compliant
- Lead Free (Pb free)



8 Pin 1.6 x 1.2 x 0.6mm Package

Functional Block Diagram (Top Thru View)

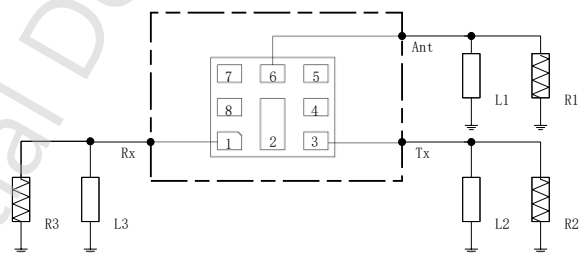

Reference Des.	Value	Description
R1	50ohm	
R2	50ohm	
R3	50ohm	
L1	3.2 nH	Inductor
L2	8.2 nH	Inductor
L3	5.6 nH	Inductor

Pin Connection

No.	Function
1	Rx
3	Tx
6	Ant
2,4,5,7,8	Ground

Electrical Specification

Transmit Port to Antenna Port

Parameter(Operable Temperature: -20 to +85 deg.C)	Min ⁽²⁾	Typ ⁽¹⁾	Max ⁽²⁾	Unit
Insertion Loss (1710~1785MHz)	\	2.1	3.0	dB
Ripple (1710~1785MHz)	\	1.0	2.0	dB
VSWR (1710~1785MHz,ANT)	\	1.6	2.0	\
VSWR (1710~1785MHz,TX)	\	1.7	2.0	\
Absolute Attenuation				
(10~1565.4MHz)	30	33	\	dB
Wideband GPS (1565.4~1573.4MHz)	40	44	\	dB
Regular GPS (1573.4~1577.5MHz)	40	44	\	dB
Wideband GPS (1577.5~1585.4MHz)	35	43	\	dB
GLONASS (1597.6~1605.9MHz)	40	45	\	dB
(1605.9~1680MHz)	30	34	\	dB
RX Band (1805~1880MHz)	48	53	\	dB
Band1 RX (2110~2170MHz)	43	48	\	dB
ISM Band (2400~2500MHz)	35	40	\	dB
Band7 RX (2620~2690MHz)	32	37	\	dB
(3420~3570MHz, 2f0)	30	34	\	dB
(5130~5355MHz, 3f0)	10	20	\	dB

Antenna Port to Receive Port

Parameter(Operable Temperature: -20 to +85 deg.C)	Min ⁽²⁾	Typ ⁽¹⁾	Max ⁽²⁾	Unit
Insertion Loss (1805~1880MHz)	\	2.6	3.5	dB
Ripple (1805~1880MHz)	\	1.5	2.5	dB
VSWR (1805~1880MHz,ANT)	\	1.7	2.0	\
VSWR (1805~1880MHz,RX)	\	1.7	2.0	\
Absolute Attenuation				
(10~1710MHz)	25	30	\	dB
TX Band (1710~1785MHz)	50	55	\	dB
ISM Band (2400~2500MHz)	48	56	\	dB
Band7 TX (2500~2570MHz)	45	54	\	dB
(2570~3515MHz)	42	47	\	dB
(3515~3760MHz, 2f₀)	40	47	\	dB
ISM 5G (4900~5950MHz)	20	25	\	dB
(5205~5660MHz, 3f₀)	20	25	\	dB

Parameter(Operable Temperature: -20 to +85 deg.C)	Min ⁽²⁾	Typ ⁽¹⁾	Max ⁽²⁾	Unit
---	--------------------	--------------------	--------------------	------

Transmit Port to Receive Port

Isolation				
1710~1785MHz	50	55	\	dB
1805~1880MHz	52	56	\	dB

(1) Reference value within band at +25°C

(2) Max/Min value within band at -20 ~ +85°C

Typical Performance at Tc=25°C

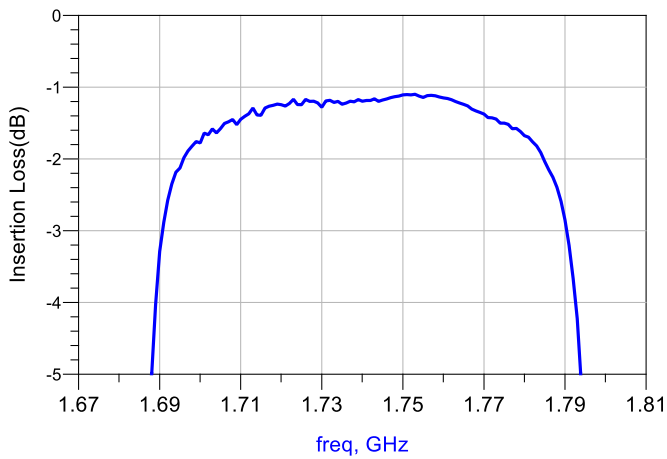

Figure1. TX-ANT Passband

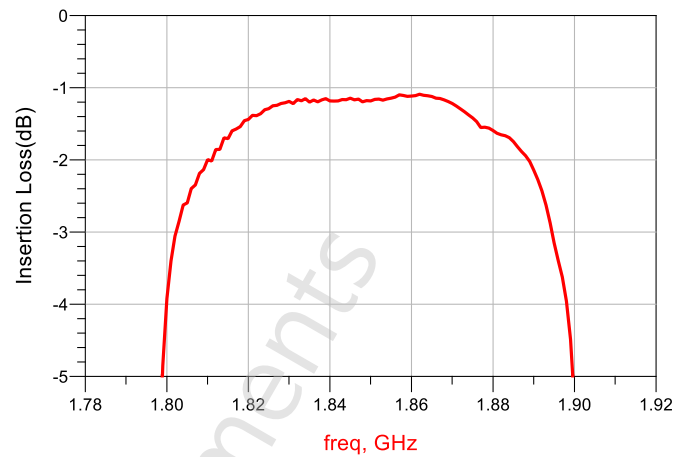

Figure2. ANT-RX Passband

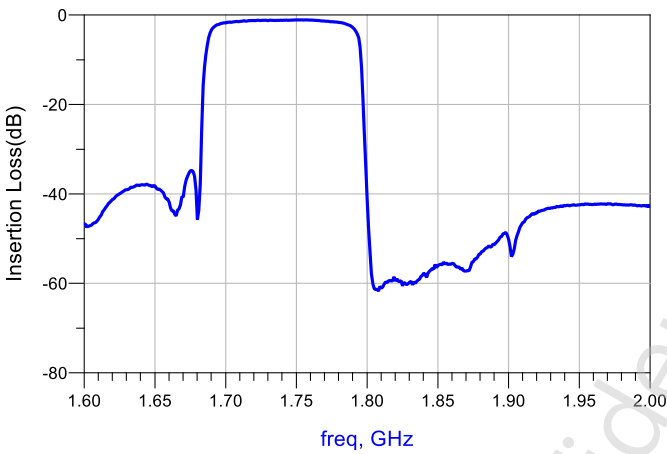

Figure3. TX-ANT

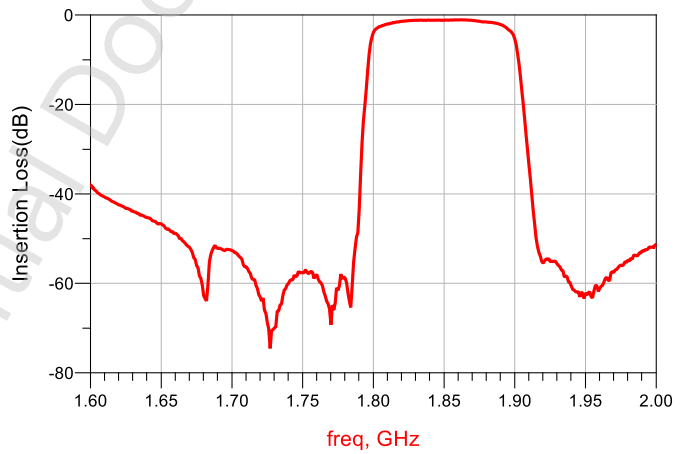

Figure4. ANT-RX

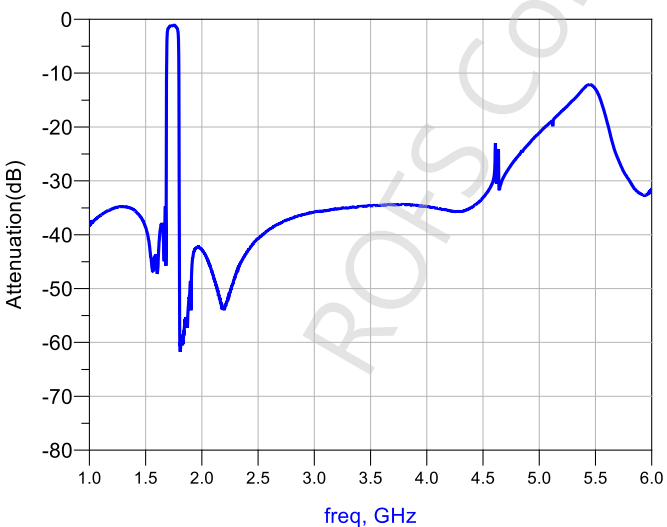

Figure5. TX-ANT Wideband

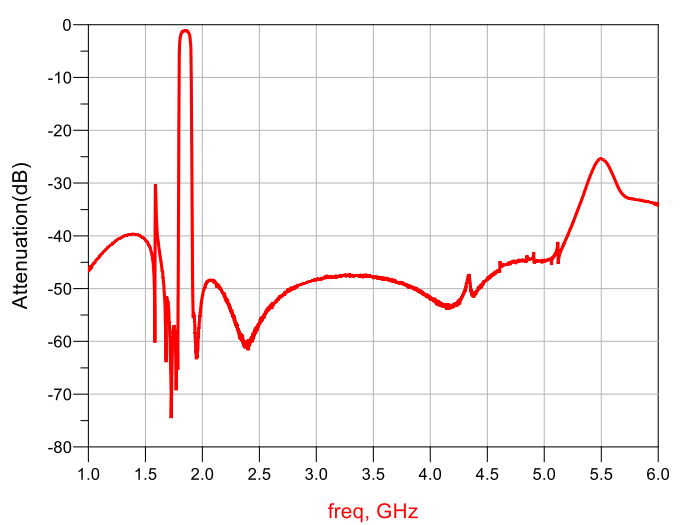

Figure6. ANT-RX Wideband

Typical Performance at Tc=25°C

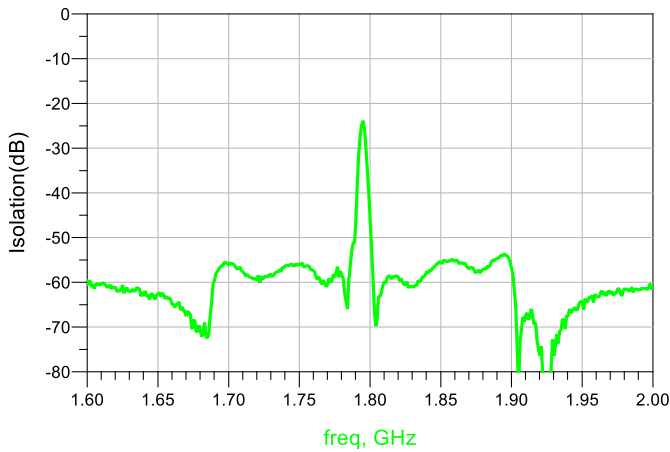

Figure7. TX - RX Isolation

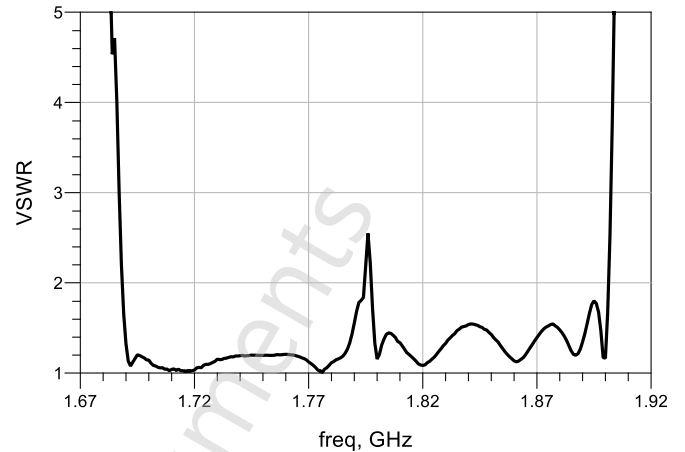

Figure8. ANT Port Return Loss

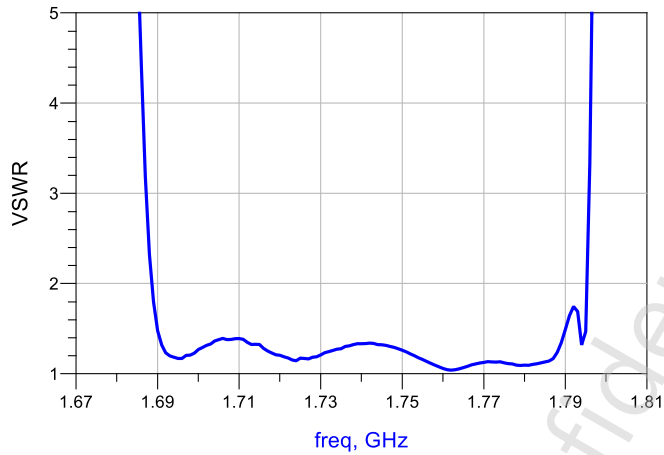

Figure9. TX Port Return Loss

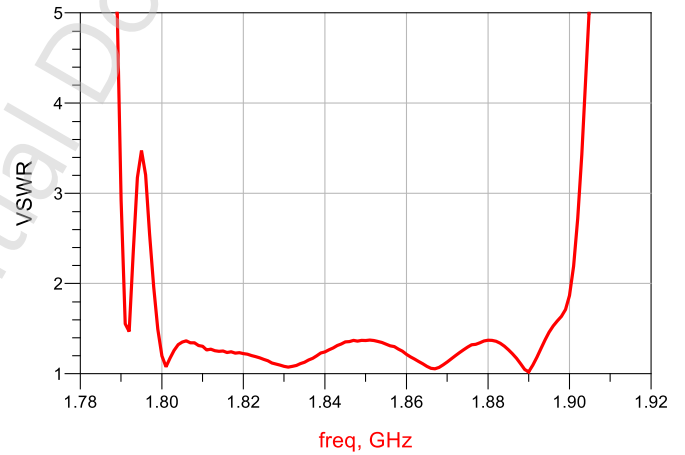

Figure10. RX Port Return Loss

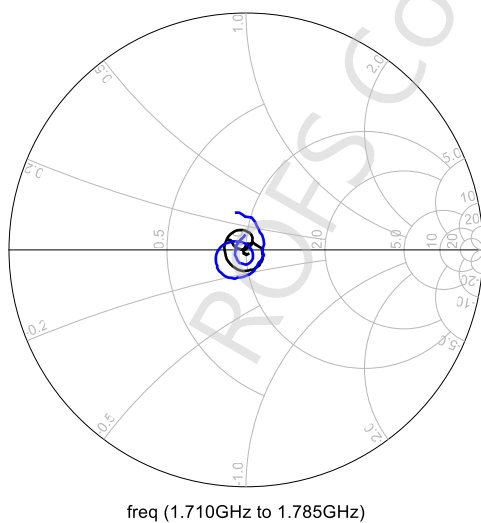

Figure11. TX/ANT Smith Chart at Tx Port

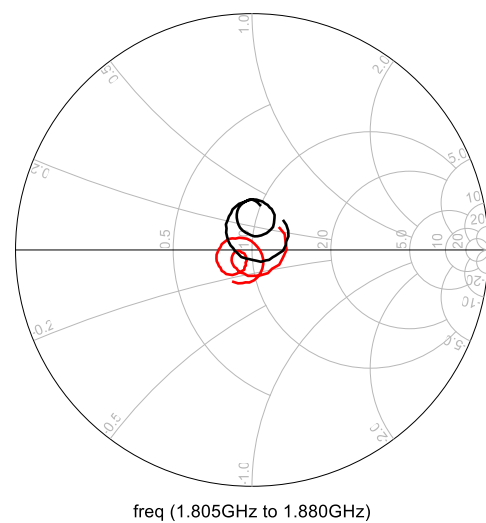
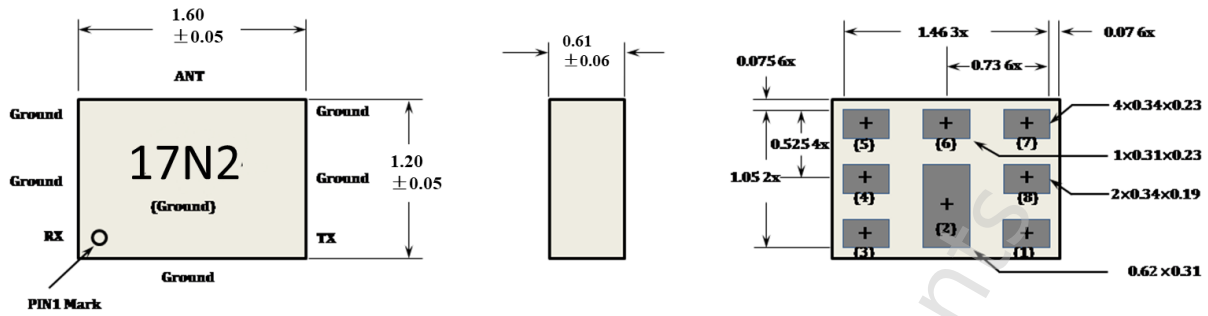

Figure12. RX/ANT Smith Chart at Rx Port

Package Outline



Top View

Side View

Bottom View

Note:

1. Dimension: mm
2. Dimensions nominal unless otherwise noted
3. Contact area are gold plated
4. Pad(1)(2) is single size, others are same size
5. 17N2 is product code

No.	Function
1	Rx
3	Tx
6	Ant
2,4,5,7,8	Ground

Order Information

P/N	Qty/Reel	Container
RSFD1702N	5000	7 inch Reel

Packing

1. Tape Dimension

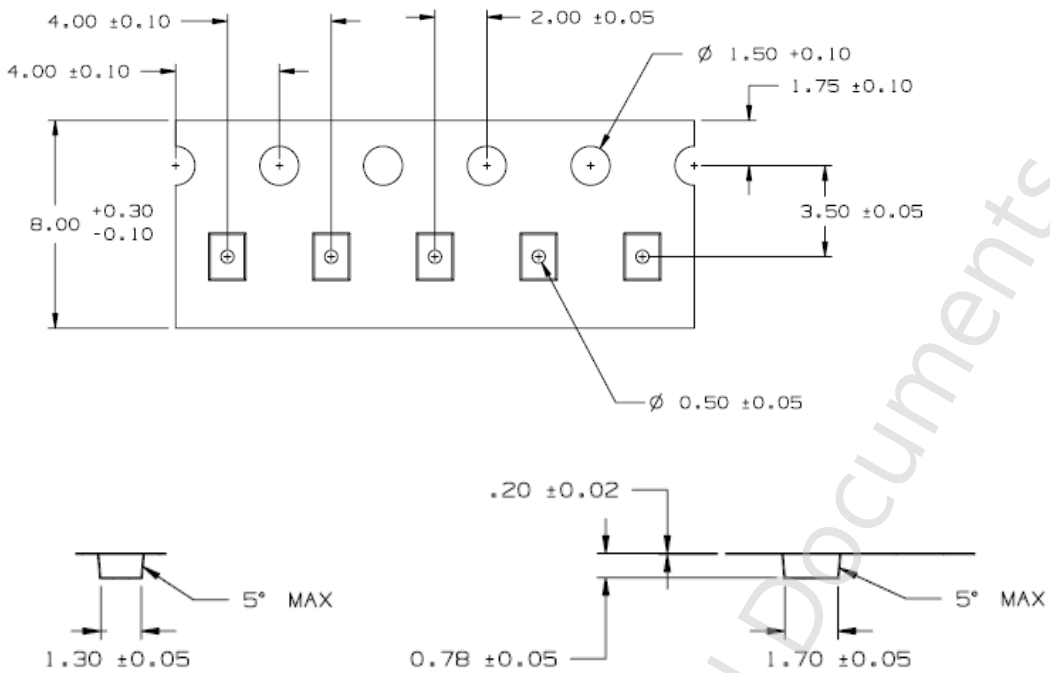

2. Reel Dimension

5000Pcs/Reel

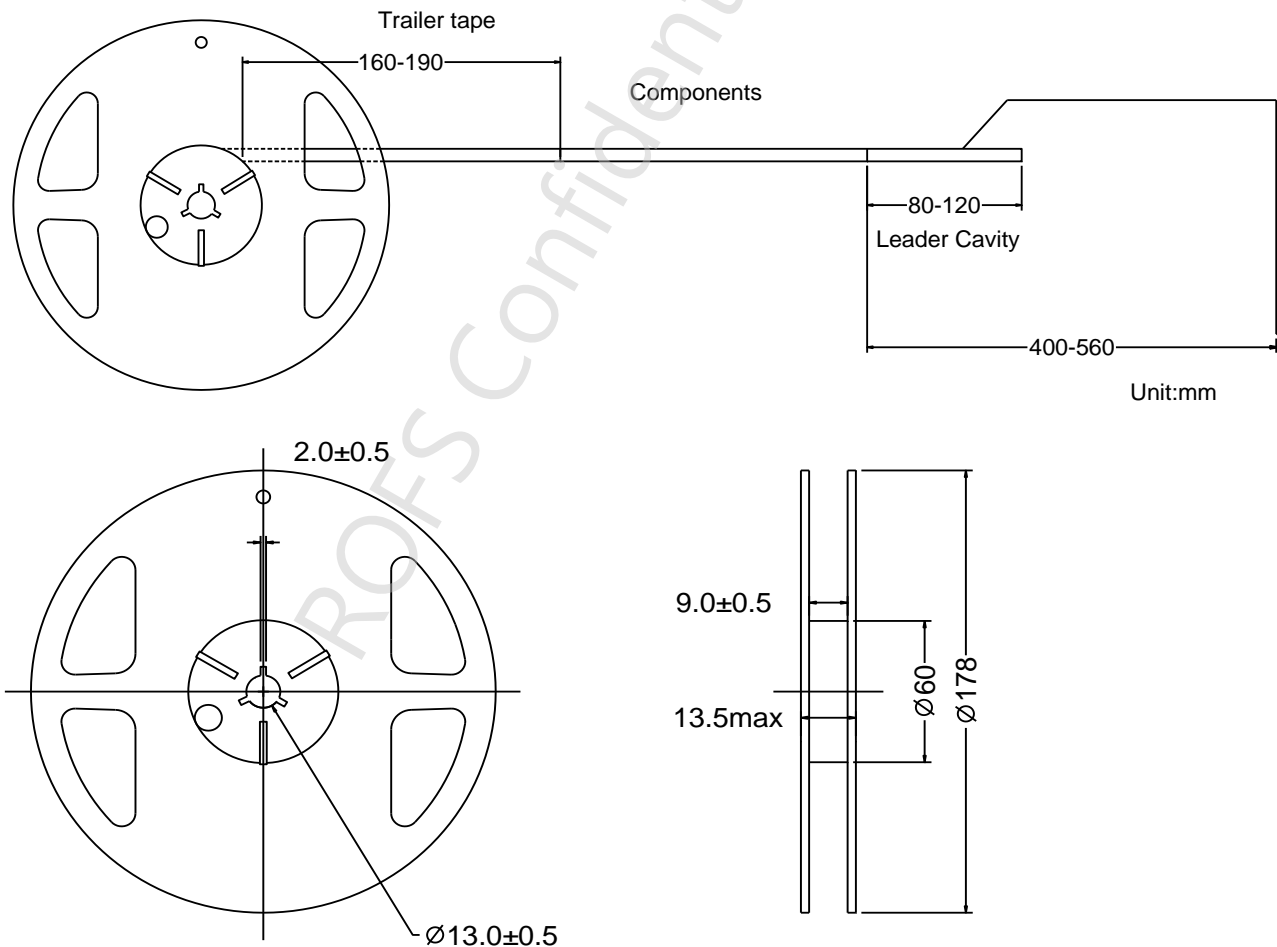

Recommended Reflow Profile

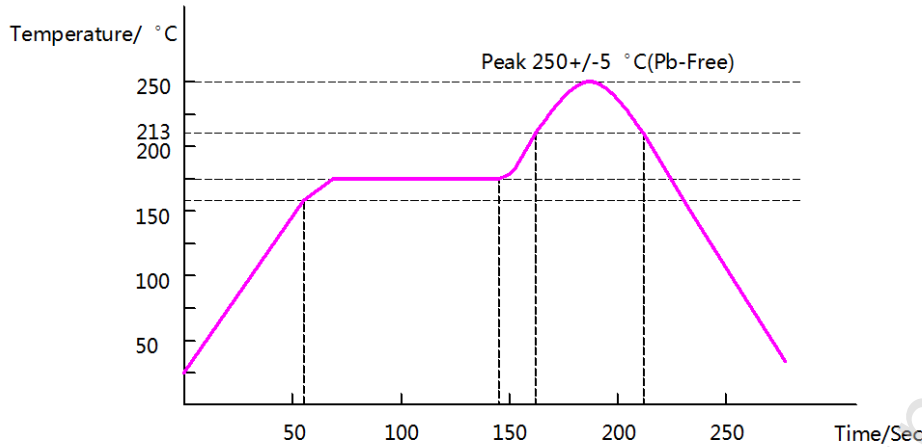

For more information, please contact: rofs_sales1@rofsmicro.com

Notes:

The specification may be changed or the product had been discontinued, please check with our sales or product engineer before order.