

General Description

The AO4805 uses advanced trench technology to provide excellent $R_{DS(ON)}$, and ultra-low low gate charge with a 25V gate rating. This device is suitable for use as a load switch or in PWM applications.

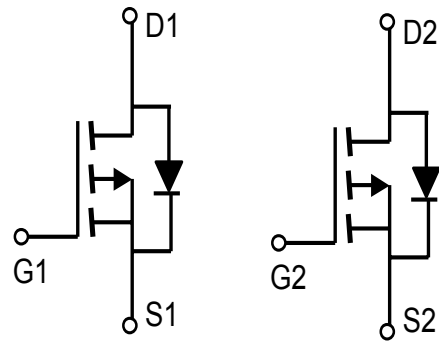

Features

- V_{DS} (V) = -30V
- I_D = -9A
- $R_{DS(ON)} < 15m\Omega$ ($V_{GS} = 10V$)
- $R_{DS(ON)} < 19m\Omega$ ($V_{GS} = 4.5V$)

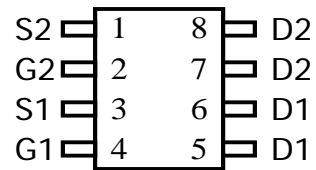

Absolute Maximum Ratings $T_A=25^\circ\text{C}$ unless otherwise noted

Parameter	Symbol	Maximum	Units
Drain-Source Voltage	V_{DS}	-30	V
Gate-Source Voltage	V_{GS}	± 20	V
Continuous Drain Current ^A	I_D	$T_A=25^\circ\text{C}$	-8
		$T_A=70^\circ\text{C}$	-6.9
Pulsed Drain Current ^B	I_{DM}	-40	A
Power Dissipation ^A	P_D	$T_A=25^\circ\text{C}$	2
		$T_A=70^\circ\text{C}$	1.44
Junction and Storage Temperature Range	T_J, T_{STG}	-55 to 150	$^\circ\text{C}$

Thermal Characteristics

Parameter	Symbol	Typ	Max	Units
Maximum Junction-to-Ambient ^A	$R_{\theta JA}$	$t \leq 10s$	50	$^\circ\text{C/W}$
Maximum Junction-to-Ambient ^A		Steady-State	73	110
Maximum Junction-to-Lead ^C	$R_{\theta JL}$	31	40	$^\circ\text{C/W}$

Electrical Characteristics (T_J=25°C unless otherwise noted)

Symbol	Parameter	Conditions	Min	Typ	Max	Units
BV _{DSS}	Drain-Source Breakdown Voltage	I _D =-250μA, V _{GS} =0V	-30			V
I _{DSS}	Zero Gate Voltage Drain Current	V _{DS} =-24V, V _{GS} =0V T _J =55°C			-1 -5	μA
I _{GSS}	Gate-Body leakage current	V _{DS} =0V, V _{GS} =±20V			±100	nA
V _{GS(th)}	Gate Threshold Voltage	V _{DS} =V _{GS} I _D =-250μA	-1	-1.5	-2.5	V
I _{D(ON)}	On state drain current	V _{GS} =-10V, V _{DS} =-5V	40			A
R _{DS(ON)}	Static Drain-Source On-Resistance	V _{GS} =-10V, I _D =-8A		12	15	mΩ
		V _{GS} =-4.5V, I _D =-5A		16	19	mΩ
g _{FS}	Forward Transconductance	V _{DS} =-5V, I _D =-8A	16	21		S
V _{SD}	Diode Forward Voltage	I _S =-1A, V _{GS} =0V		-0.75	-1	V
I _S	Maximum Body-Diode Continuous Current				-2.6	A
C _{iss}	Input Capacitance	V _{GS} =0V, V _{DS} =-15V, f=1MHz		2076		pF
C _{oss}	Output Capacitance			503		pF
C _{rss}	Reverse Transfer Capacitance			302		pF
R _g	Gate resistance	V _{GS} =0V, V _{DS} =0V, f=1MHz		2		Ω
Q _g	Total Gate Charge	V _{GS} =-10V, V _{DS} =-15V, I _D =-8A		39		nC
Q _{gs}	Gate Source Charge			8		nC
Q _{gd}	Gate Drain Charge			11.4		nC
t _{D(on)}	Turn-On DelayTime			12.7		ns
t _r	Turn-On Rise Time	V _{GS} =-10V, V _{DS} =-15V, R _L =1.8Ω,		7		ns
t _{D(off)}	Turn-Off DelayTime	R _{GEN} =3Ω		25.2		ns
t _f	Turn-Off Fall Time			12		ns
t _{rr}	Body Diode Reverse Recovery Time	I _F =-8A, dI/dt=100A/μs		32		ns
Q _{rr}	Body Diode Reverse Recovery Charge	I _F =-8A, dI/dt=100A/μs		26		nC

A: The value of R_{θJA} is measured with the device mounted on 1in² FR-4 board with 2oz. Copper, in a still air environment with T_A=25°C. The value in any a given application depends on the user's specific board design. The current rating is based on the t≤ 10s thermal resistance rating.

B: Repetitive rating, pulse width limited by junction temperature.

C. The R_{θJA} is the sum of the thermal impedance from junction to lead R_{θJL} and lead to ambient.

D. The static characteristics in Figures 1 to 6,12,14 are obtained using 80μs pulses, duty cycle 0.5% max.

E. These tests are performed with the device mounted on 1 in² FR-4 board with 2oz. Copper, in a still air environment with T_A=25°C. The SOA curve provides a single pulse rating.

TYPICAL ELECTRICAL AND THERMAL CHARACTERISTICS

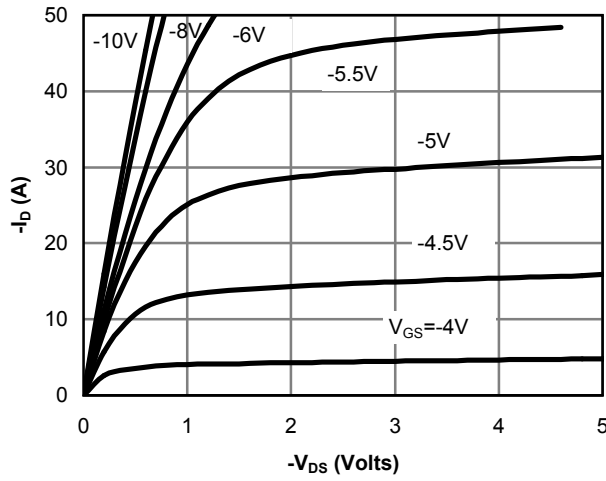

Fig 1: On-Region Characteristics

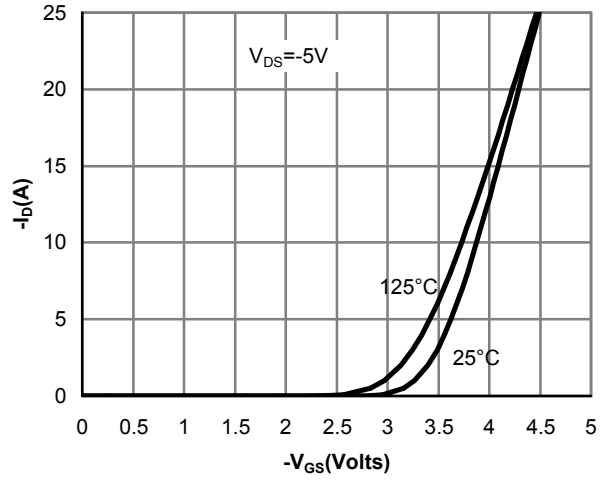

Figure 2: Transfer Characteristics

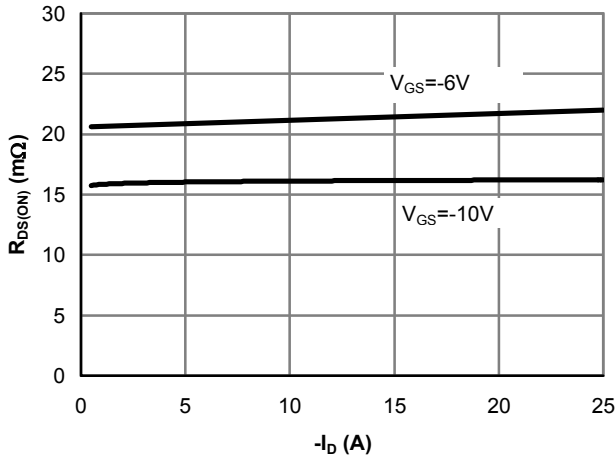

Figure 3: On-Resistance vs. Drain Current and Gate Voltage

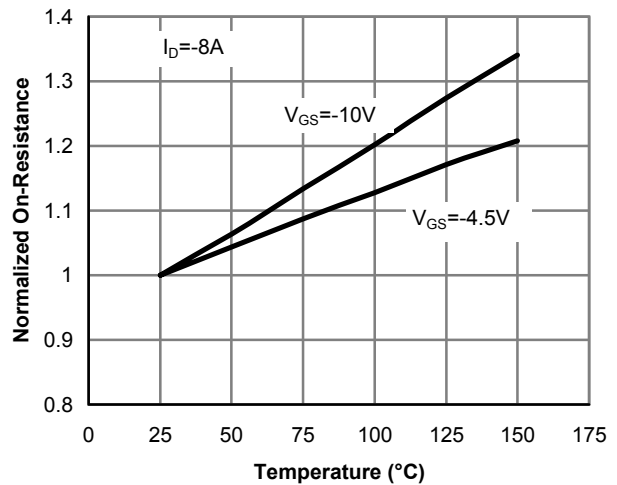

Figure 4: On-Resistance vs. Junction Temperature

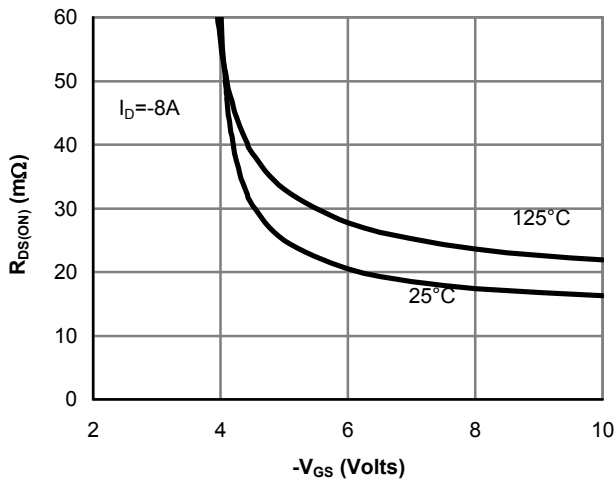

Figure 5: On-Resistance vs. Gate-Source Voltage

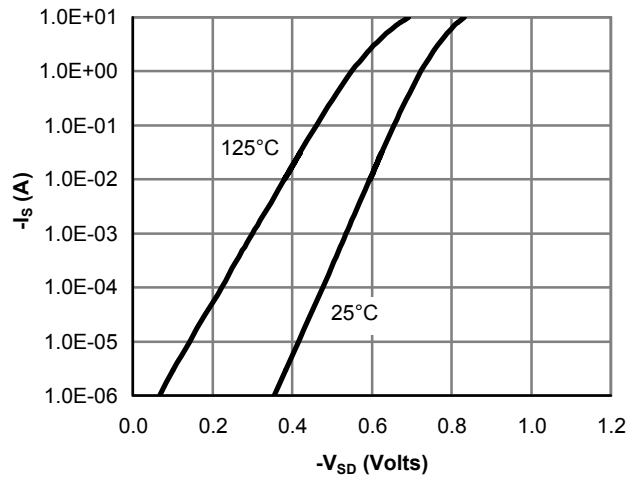

Figure 6: Body-Diode Characteristics

TYPICAL ELECTRICAL AND THERMAL CHARACTERISTICS

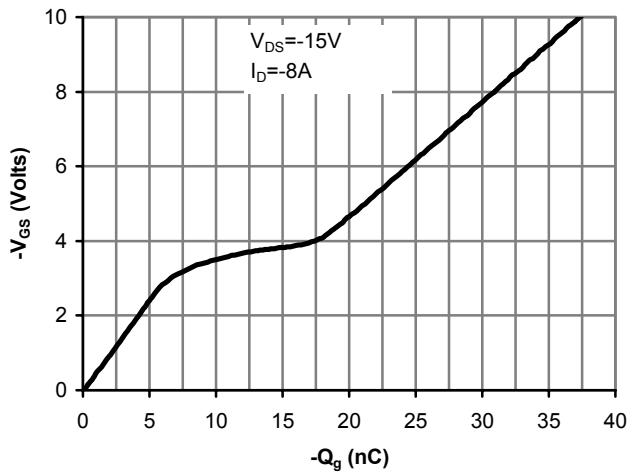

Figure 7: Gate-Charge Characteristics

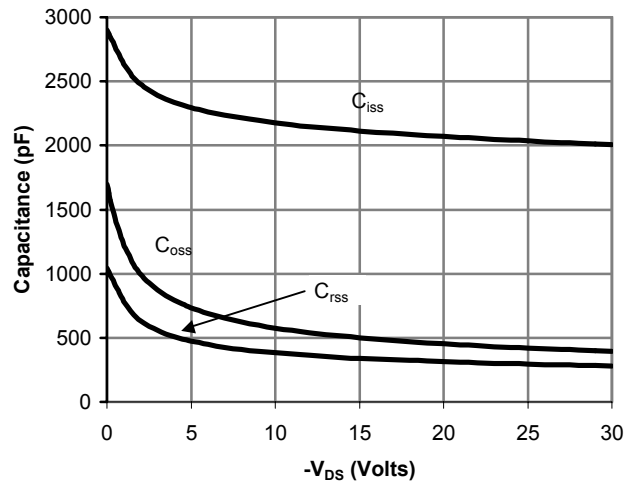

Figure 8: Capacitance Characteristics

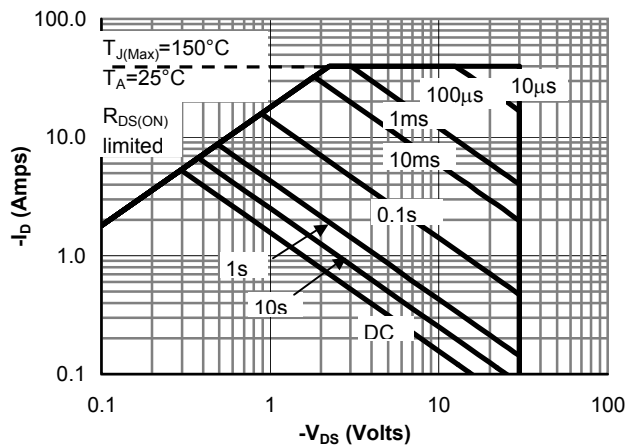

Figure 9: Maximum Forward Biased Safe Operating Area (Note E)

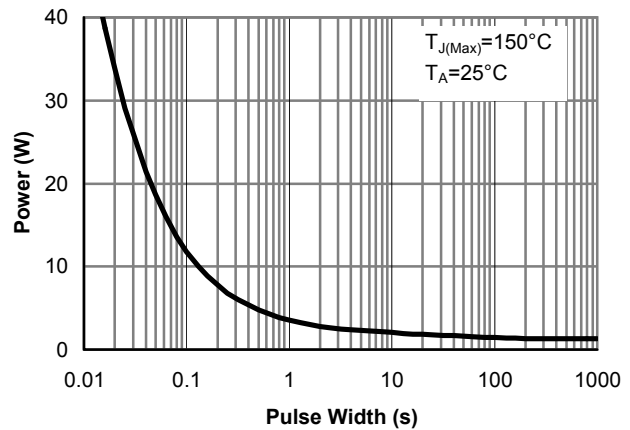

Figure 10: Single Pulse Power Rating Junction-to-Ambient (Note E)

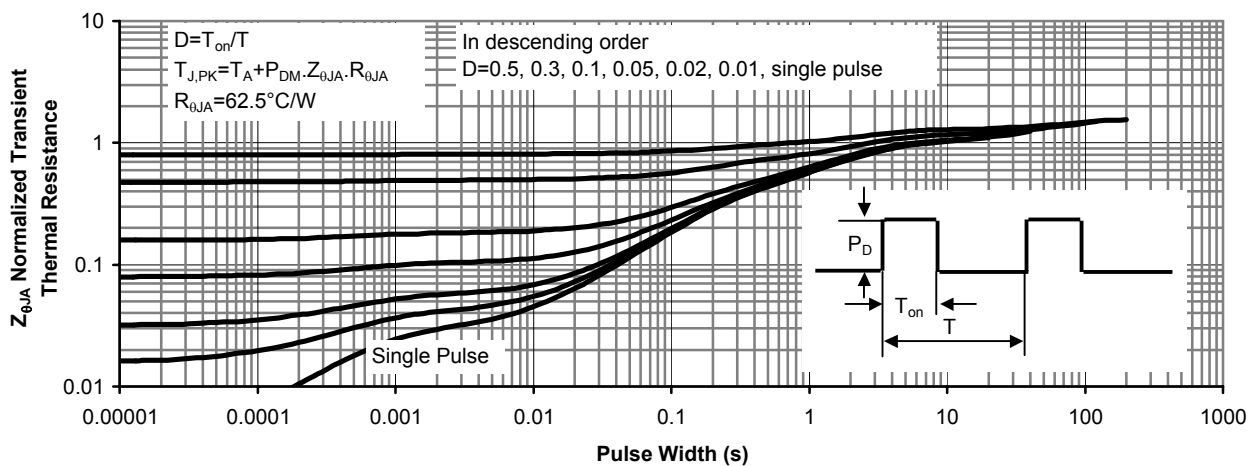
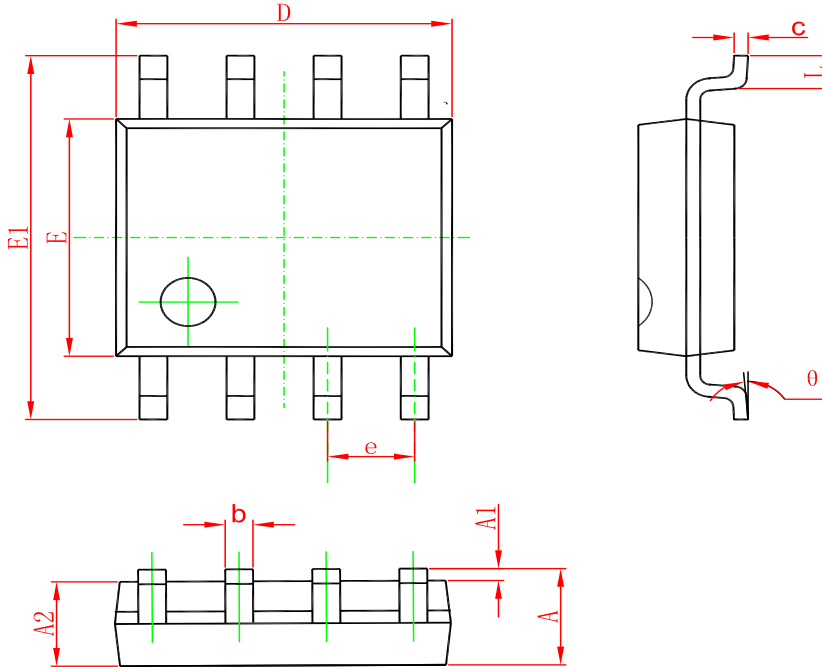

Figure 11: Normalized Maximum Transient Thermal Impedance

PACKAGE OUTLINE DIMENSIONS

SOP-8



Symbol	Dimensions In Millimeters		Dimensions In Inches	
	Min	Max	Min	Max
A	1.350	1.750	0.053	0.069
A1	0.100	0.250	0.004	0.010
A2	1.350	1.550	0.053	0.061
b	0.330	0.510	0.013	0.020
c	0.170	0.250	0.006	0.010
D	4.700	5.100	0.185	0.200
E	3.800	4.000	0.150	0.157
E1	5.800	6.200	0.228	0.244
e	1.270(BSC)		0.050(BSC)	
L	0.400	1.270	0.016	0.050
θ	0°	8°	0°	8°

Marking

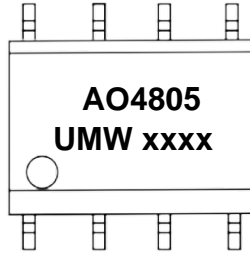

("xxxx"代表年份周期)

Ordering information

Order code	Package	Baseqty	Deliverymode
UMW AO4805	SOP-8	3000	Tape and reel