

### General Features

$V_{(BR)DSS}$	$R_{DS(on)MAX}$	$I_D$
60V	105mΩ@10V	3A
	125mΩ@4.5V	

### Application

Load/Power Switching  
Interfacing Switching  
Battery Management for Ultra Small Portable  
Logic Level Shift

### Package and Pin Configuration

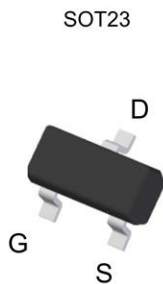

### Circuit diagram

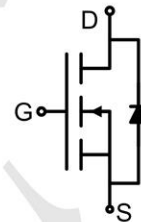

### Marking:

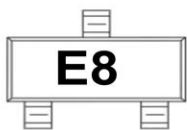

### Absolute Maximum Ratings ( $T_A=25^{\circ}C$ unless otherwise noted)

Parameter	Symbol	Value	Unit
Drain-Source Voltage	$V_{DS}$	60	V
Gate-Source Voltage	$V_{GS}$	±20	V
Continuous Drain Current	$I_D$	3	A
Pulsed Drain Current (note 1)	$I_{DM}$	10	A
Power Dissipation	$P_D$	0.35	W
Thermal Resistance from Junction to Ambient (note 2)	$R_{\theta JA}$	357	$^{\circ}C/W$
Junction Temperature	$T_J$	150	$^{\circ}C$
Storage Temperature	$T_{STG}$	-55~+150	$^{\circ}C$

**Electrical Characteristics ( $T_A=25^\circ\text{C}$  unless otherwise noted)**

Parameter	Symbol	Test Condition	Min	Typ	Max	Unit
<b>STATIC CHARACTERISTICS</b>						
Drain-source breakdown voltage	$V_{(BR)DSS}$	$V_{GS} = 0V, I_D = 250\mu A$	60			V
Zero gate voltage drain current	$I_{DSS}$	$V_{DS} = 60V, V_{GS} = 0V$			1	$\mu A$
Gate-body leakage current	$I_{GSS}$	$V_{GS} = \pm 20V, V_{DS} = 0V$			$\pm 100$	nA
Gate threshold voltage (note 3)	$V_{GS(th)}$	$V_{DS} = V_{GS}, I_D = 250\mu A$	0.5		2	V
Drain-source on-resistance (note 3)	$R_{DS(on)}$	$V_{GS} = 10V, I_D = 3A$			105	m $\Omega$
		$V_{GS} = 4.5V, I_D = 3A$			125	m $\Omega$
Forward transconductance (note 3)	$g_{FS}$	$V_{DS} = 15V, I_D = 2A$	1.4			S
Diode forward voltage (note 3)	$V_{SD}$	$I_S = 3A, V_{GS} = 0V$			1.2	V
<b>DYNAMIC CHARACTERISTICS (note 4)</b>						
Input Capacitance	$C_{iss}$	$V_{DS} = 30V, V_{GS} = 0V, f = 1MHz$		247		pF
Output Capacitance	$C_{oss}$			34		pF
Reverse Transfer Capacitance	$C_{rss}$			19.5		pF
<b>SWITCHING CHARACTERISTICS (note 4)</b>						
Turn-on delay time	$t_{d(on)}$	$V_{GS} = 10V, V_{DD} = 30V,$ $I_D = 1.5A, R_{GEN} = 1\Omega$		6		ns
Turn-on rise time	$t_r$			15		ns
Turn-off delay time	$t_{d(off)}$			15		ns
Turn-off fall time	$t_f$			10		ns
Total Gate Charge	$Q_g$	$V_{DS} = 30V, V_{GS} = 4.5V, I_D = 3A$		6		nC
Gate-Source Charge	$Q_{gs}$			1		nC
Gate-Drain Charge	$Q_{gd}$			1.3		nC

Typical Electrical and Thermal Characteristics (Curves)

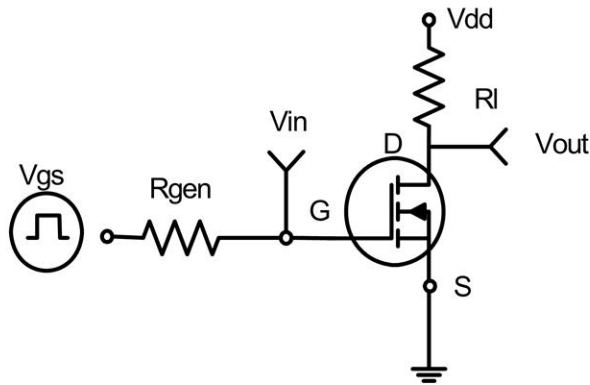

Figure 1: Switching Test Circuit

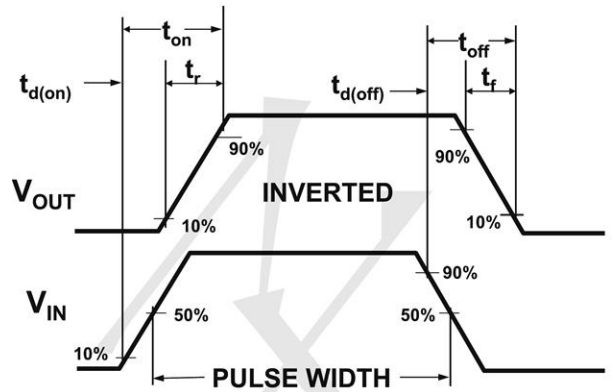

Figure 2: Switching Waveforms

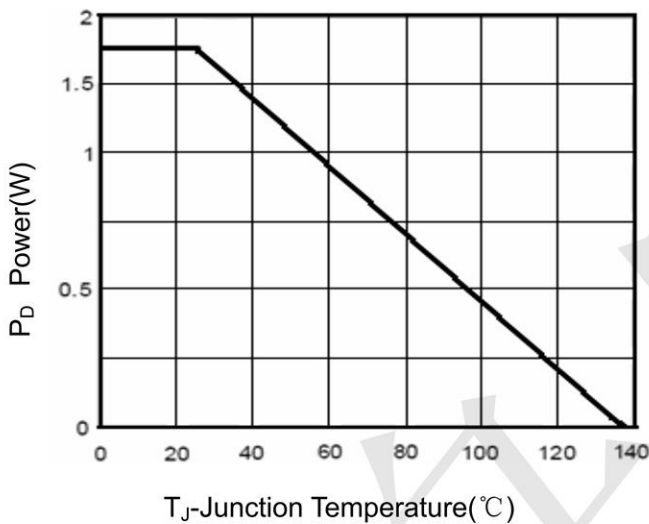

Figure 3 Power Dissipation

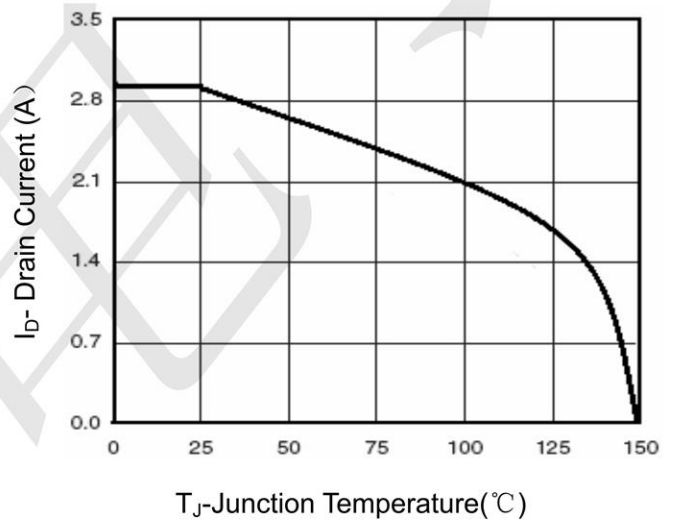

Figure 4 Drain Current

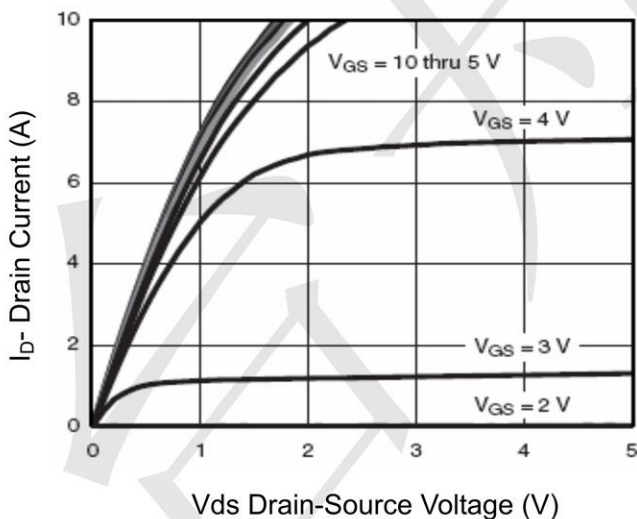

Figure 5 Output Characteristics

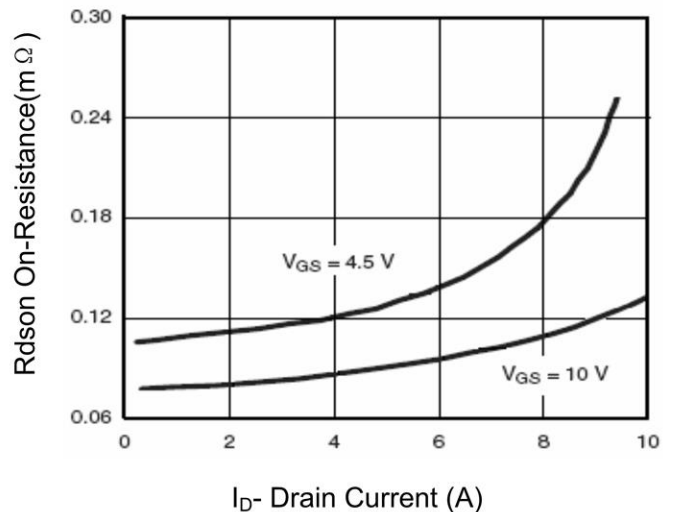

Figure 6 Drain-Source On-Resistance

Typical Electrical and Thermal Characteristics (Curves)

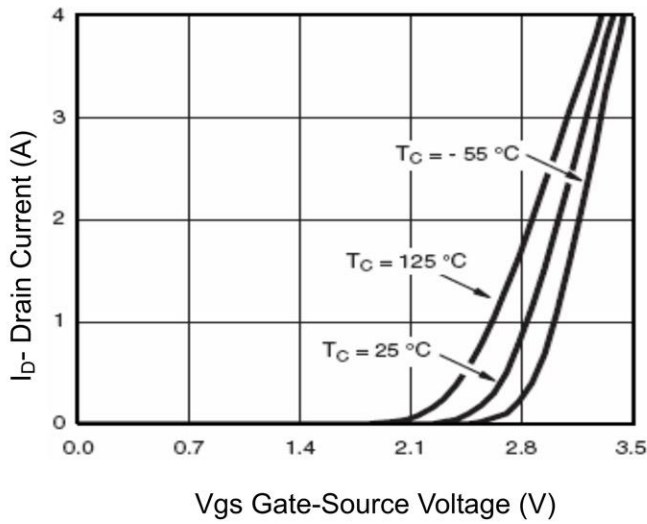

Figure 7 Transfer Characteristics

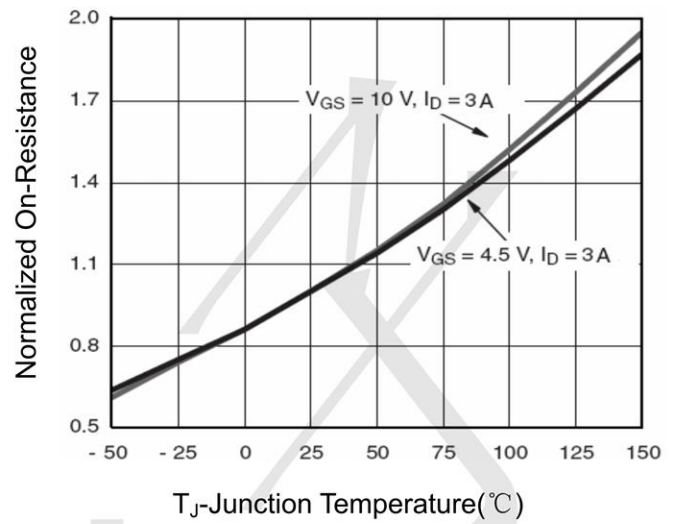

Figure 8 Drain-Source On-Resistance

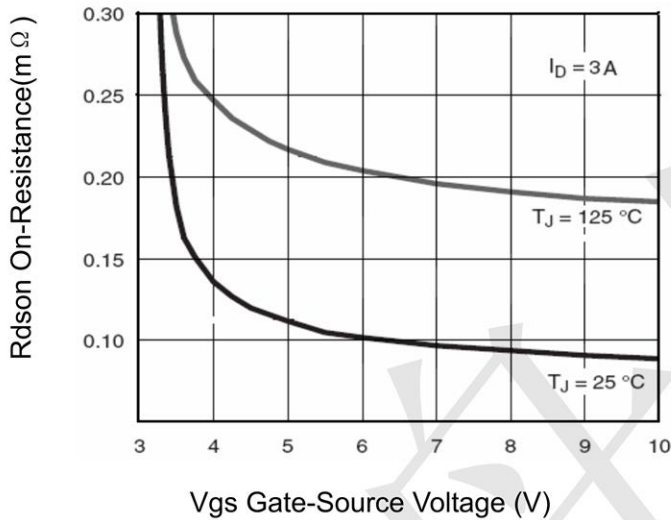

Figure 9  $R_{DS(on)}$  vs  $V_{GS}$

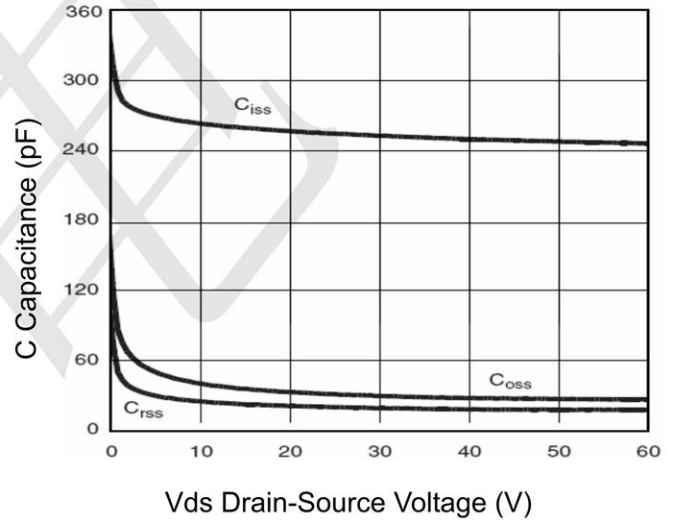

Figure 10 Capacitance vs  $V_{DS}$

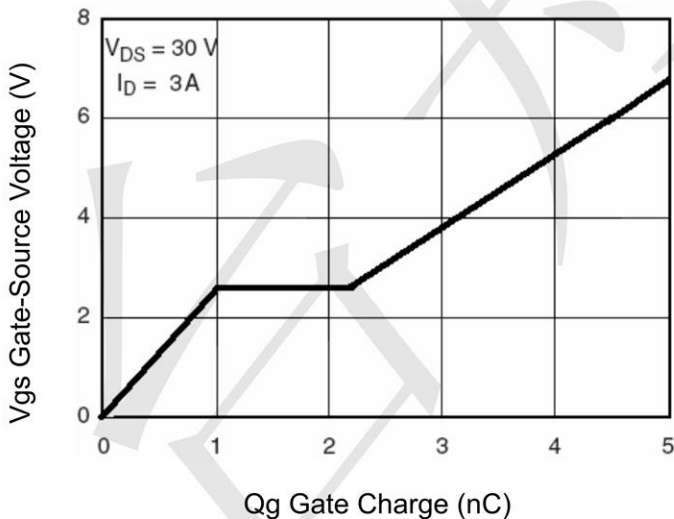

Figure 11 Gate Charge

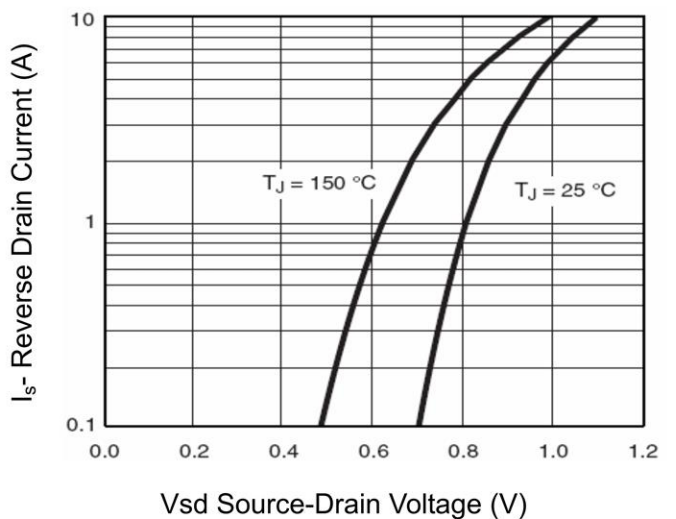
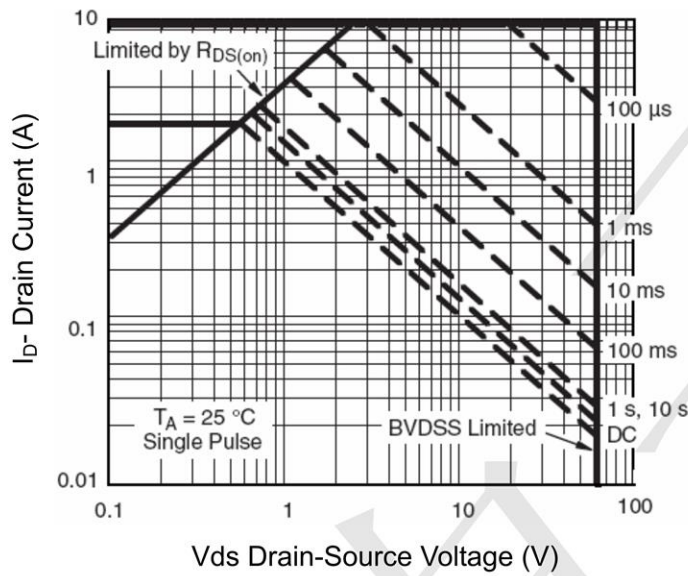
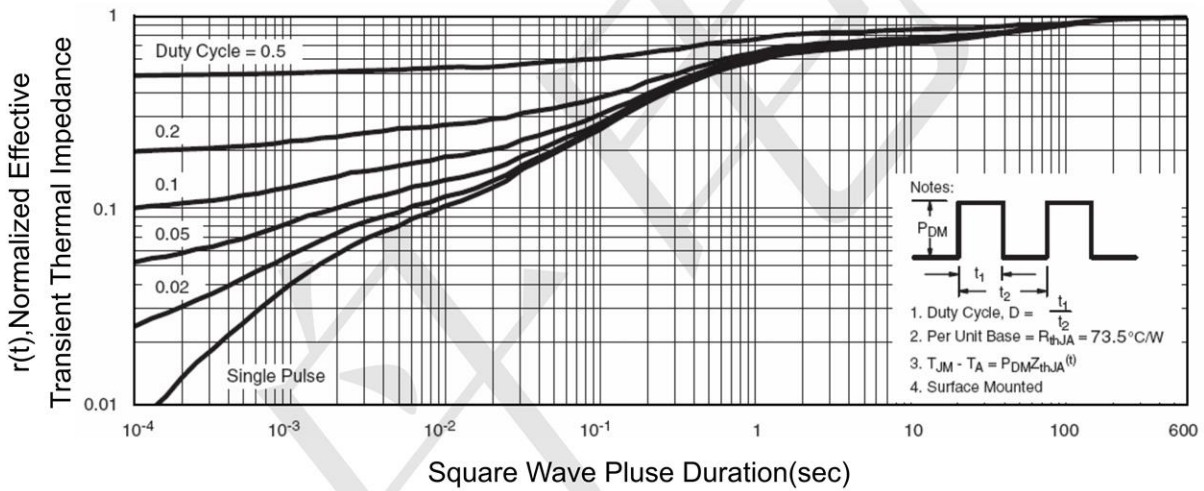

Figure 12 Source- Drain Diode Forward



**Figure 13 Safe Operation Area**



**Figure 14 Normalized Maximum Transient Thermal Impedance**

Package Outline Dimensions (SOT-23)

[www.sot23.com.tw](http://www.sot23.com.tw)

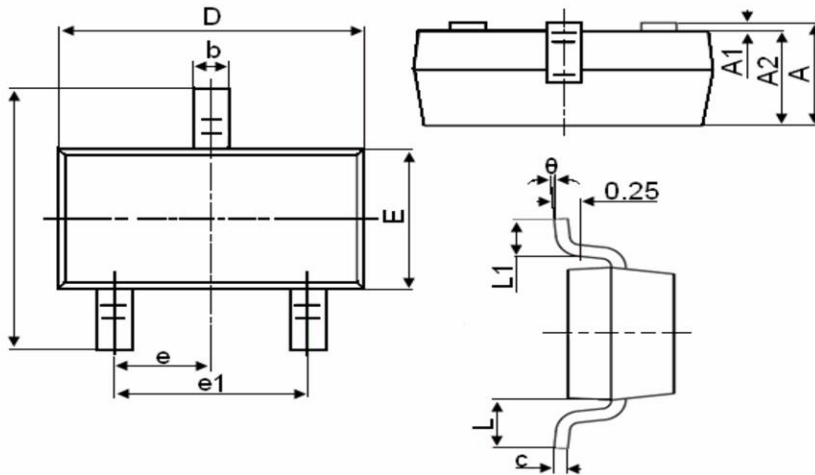

Symbol	Dimensions in Millimeters	
	MIN.	MAX.
A	0.900	1.150
A1	0.000	0.100
A2	0.900	1.050
b	0.300	0.500
c	0.080	0.150
D	2.800	3.000
E	1.200	1.400
E1	2.250	2.550
e	0.950TYP	
e1	1.800	2.000
L	0.550REF	
L1	0.300	0.500
θ	0°	8°