

# SMD Power Inductor

## CDRH127/LD



Recommended Type

### Description

- Ferrite drum ring structure
- Magnetically Shielded
- LxWxH: 12.3x12.3x8.0 mm Max.
- Operating temperature range: -40°C~ +100°C (Including self-heating)
- Storage temperature range: -40°C ~ +100°C
- Solder reflow temperature: 260 °C peak



### Applications

- Ideally used in notebook PC, LCD TV, DVD, game machine, STB, projector, etc. as DC-DC converter inductors

### Dimension - [mm]

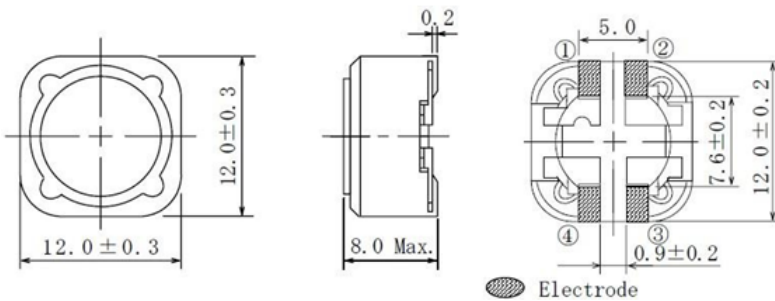

### Recommended Land Pattern - [mm]

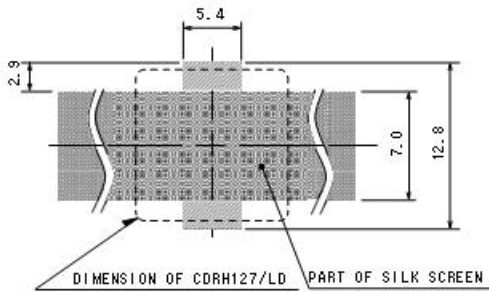

No vias and traces in the restricted area underneath the coil

### Connection

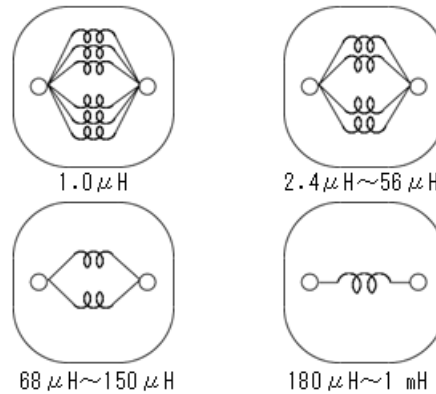

# SMD Power Inductor

## CDRH127/LD



### Electrical Characteristics

Part No.	Inductance ( $\mu$ H)	D.C.R. ( $\Omega$ ) Max. (Typ.)	Saturation Current (A) Max. (Typ.) ※2	Temperature Rise Current (A) (Typ.) ※3
CDRH127/LDNP-1R0NC	1.0 $\pm$ 30%	6.50m(5.00m)	21.8(27.2)	(15.8)
CDRH127/LDNP-2R4NC	2.4 $\pm$ 30%	10.5m(8.10m)	14.2(17.7)	(11.5)
CDRH127/LDNP-3R5NC	3.5 $\pm$ 30%	12.4m(9.50m)	11.8(14.7)	(10.3)
CDRH127/LDNP4R6NC	4.6 $\pm$ 30%	13.8m(10.6m)	10.4(13.0)	(10.1)
CDRH127/LDNP-5R8NC	5.8 $\pm$ 30%	16.2m(12.4m)	9.00(11.2)	(9.60)
CDRH127/LDNP-7R4NC	7.4 $\pm$ 30%	17.7m(13.6m)	8.40(10.5)	(8.70)
CDRH127/LDNP-100MC	10 $\pm$ 20%	19.5m(15.0m)	6.70(8.40)	(7.80)
CDRH127/LDNP-120MC	12 $\pm$ 20%	21.3m(16.4m)	6.45(7.50)	(7.40)
CDRH127/LDNP-150MC	15 $\pm$ 20%	26.4m(20.3m)	5.65(6.80)	(7.10)
CDRH127/LDNP-180MC	18 $\pm$ 20%	28.0m(21.5m)	5.10(6.70)	(6.60)
CDRH127/LDNP-220MC	22 $\pm$ 20%	36.4m(28.0m)	4.70(5.80)	(6.30)
CDRH127/LDNP-270MC	27 $\pm$ 20%	41.6 m(32.0m)	4.20(5.40)	(5.70)
CDRH127/LDNP-330MC	33 $\pm$ 20%	53.3m(41.0m)	3.90(4.80)	(5.10)
CDRH127/LDNP-390MC	39 $\pm$ 20%	60.5m(46.5m)	3.50(4.40)	(4.50)
CDRH127/LDNP-470MC	47 $\pm$ 20%	78.0m(60.0m)	3.25(4.10)	(4.10)
CDRH127/LDNP-560MC	56 $\pm$ 20%	90.0m(69.0m)	2.90(3.60)	(3.60)
CDRH127/LDNP-680MC	68 $\pm$ 20%	120m(92.0m)	2.60(3.40)	(3.20)
CDRH127/LDNP-820MC	82 $\pm$ 20%	119m(910m)	2.40(2.85)	(2.95)
CDRH127/LDNP-101MC	100 $\pm$ 20%	151m(119m)	2.10(2.70)	(2.60)
CDRH127/LDNP-121MC	120 $\pm$ 20%	169m(130m)	1.90(2.60)	(2.40)
CDRH127/LDNP-151MC	150 $\pm$ 20%	227m(174m)	1.80(2.15)	(2.15)
CDRH127/LDNP-181MC	180 $\pm$ 20%	299m(230m)	1.55(2.05)	(1.90)
CDRH127/LDNP-221MC	220 $\pm$ 20%	338m(260m)	1.45(1.90)	(1.75)
CDRH127/LDNP-271MC	270 $\pm$ 20%	419m(322m)	1.30(1.60)	(1.60)
CDRH127/LDNP-331MC	330 $\pm$ 20%	471m(362m)	1.20(1.45)	(1.50)
CDRH127/LDNP-391MC	390 $\pm$ 20%	572m(440m)	1.10(1.40)	(1.40)
CDRH127/LDNP-471MC	470 $\pm$ 20%	741m(570m)	1.00(1.30)	(1.25)

Note: This specification is subject to change without notice. Please contact your nearest sales office for updated information when placing an order.

# SMD Power Inductor

## CDRH127/LD



Recommended Type

CDRH127/LDNP-561MC	560±20%	852m(655m)	950m(1.12)	(1.10)
CDRH127/LDNP-681MC	680±20%	1.13(870m)	850m(1.10)	(1.03)
CDRH127/LDNP-821MC	820±20%	1.24(950m)	750m(920m)	(920m)
CDRH127/LDNP-102MC	1000±20%	1.50(1.15)	700m(860m)	(850m)

※ 1. Measuring frequency (L) : 1.0μH - 7.4μH (100kHz), 10μH – 1.0mH (1kHz)

※ 2. Saturation current: This indicates the actual value of D.C. current when the inductance becomes 25% lower than its initial value.

※ 3. Temperature rise current: The actual value of D.C. current when the temperature of coil becomes ΔT=40°C. (Ta=20°C)

### Solder Reflow Condition

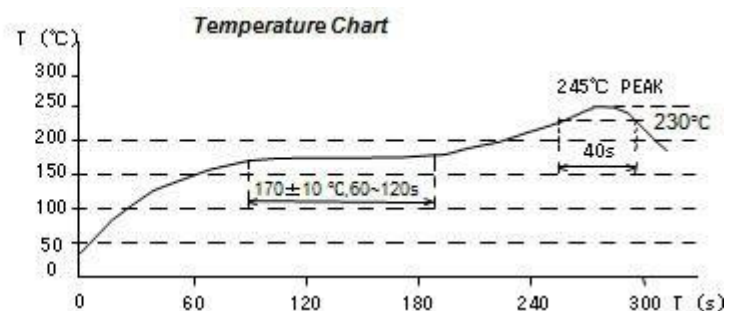
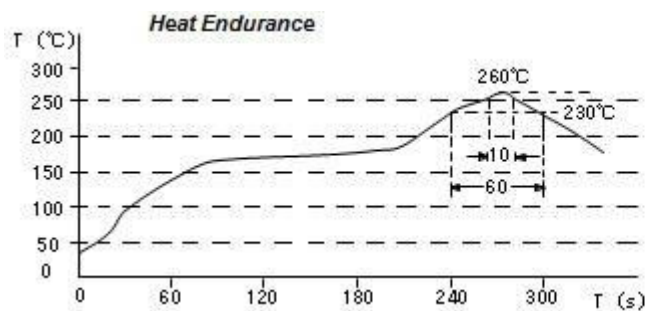

# SMD Power Inductor

## CDRH127/LD



### Saturation Current & Temperature Rise Graph

— L (20°C)    — L (100°C)    —  $\Delta T$

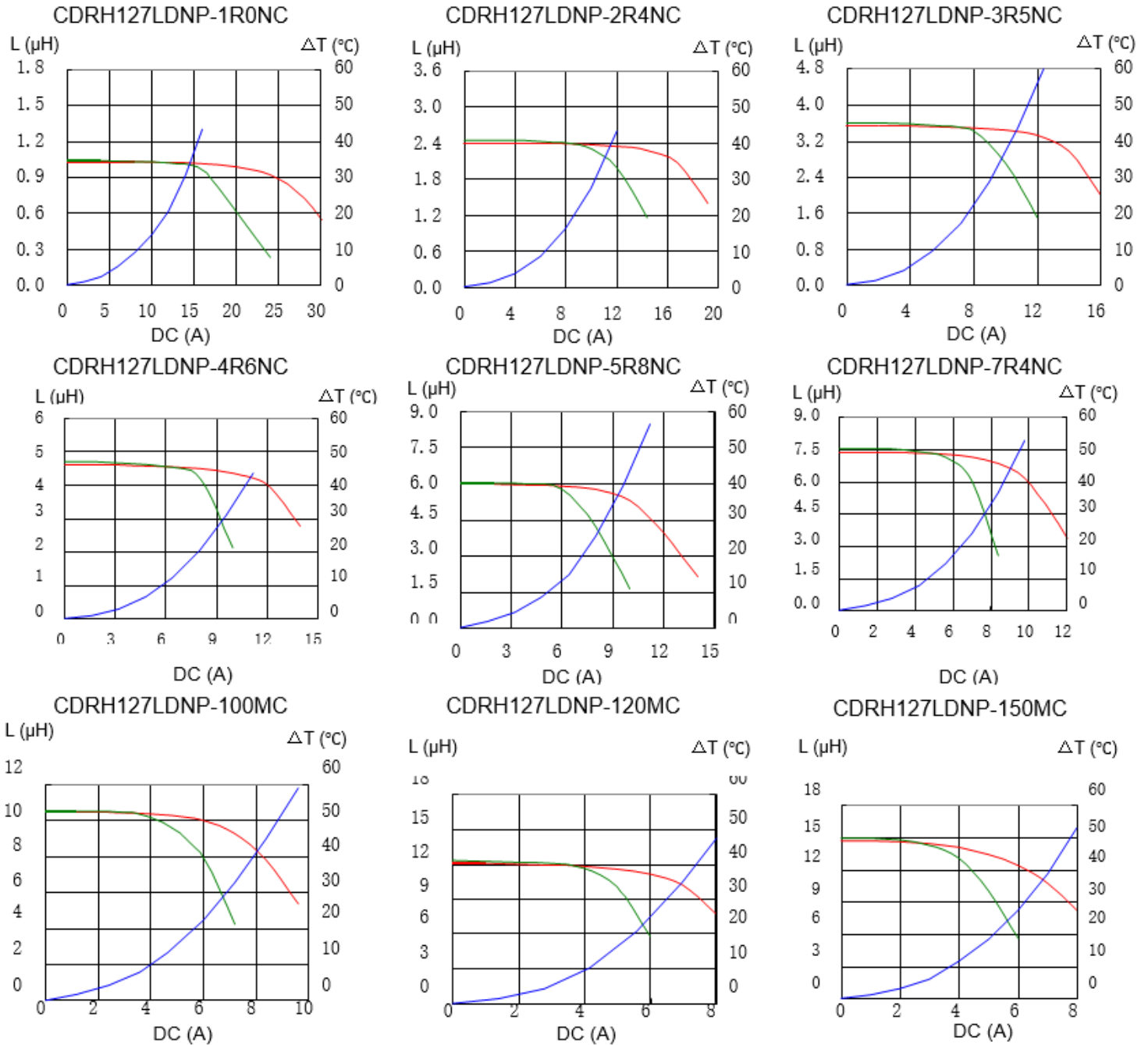

# SMD Power Inductor

## CDRH127/LD



— L (20°C)    — L (100°C)    —  $\Delta T$

CDRH127LDNP-180MC

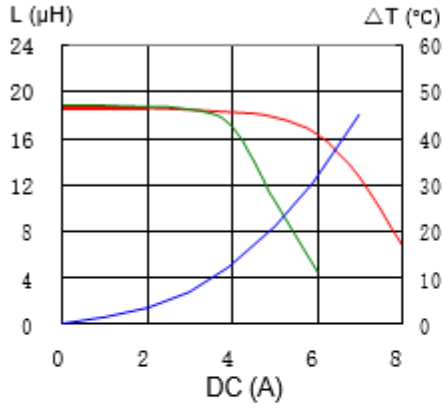

CDRH127LDNP-220MC

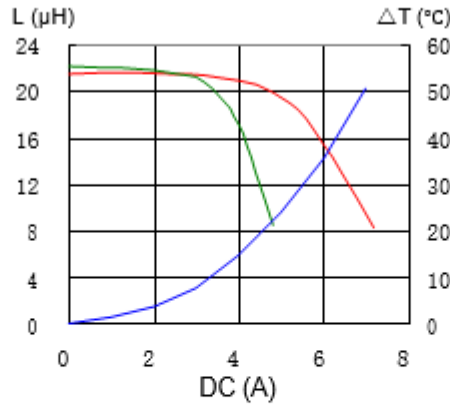

CDRH127LDNP-270MC

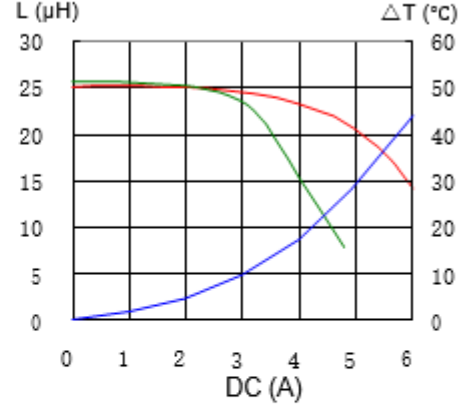

CDRH127LDNP-330MC

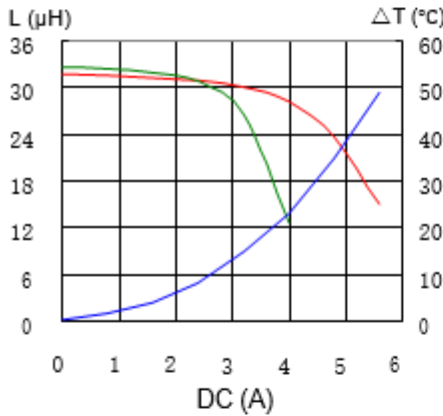

CDRH127LDNP-390MC

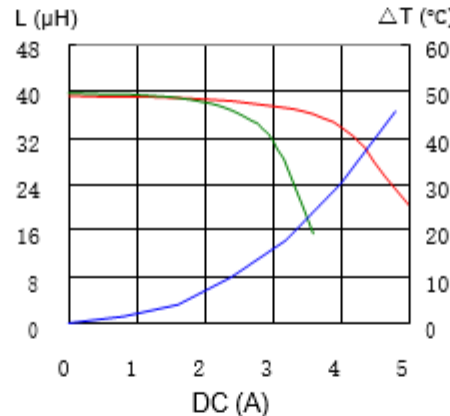

CDRH127LDNP-470MC

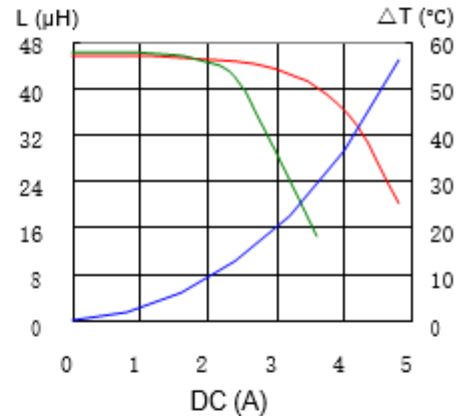

CDRH127LDNP-560MC

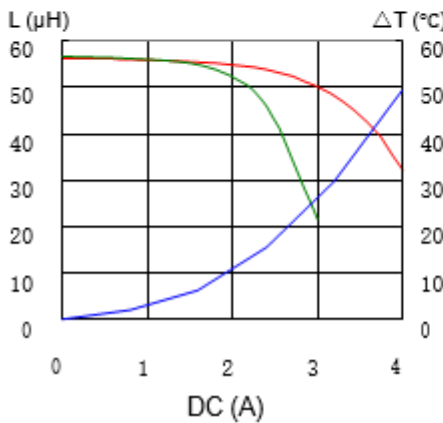

CDRH127LDNP-680MC

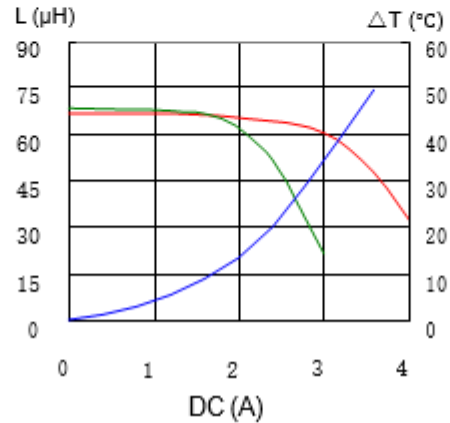

CDRH127LDNP-820MC

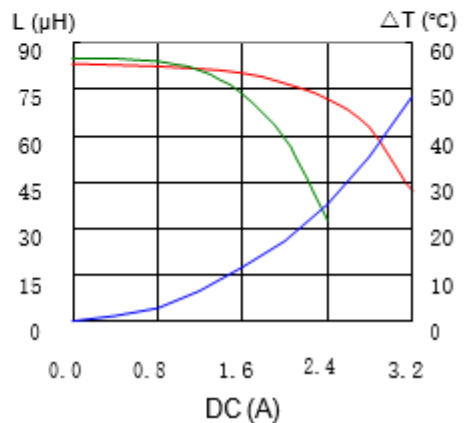

# SMD Power Inductor

## CDRH127/LD



— L (20°C)    — L (100°C)    —  $\Delta T$

CDRH127LDNP-101MC

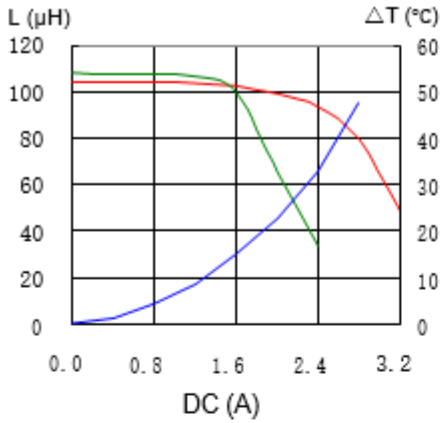

CDRH127LDNP-121MC

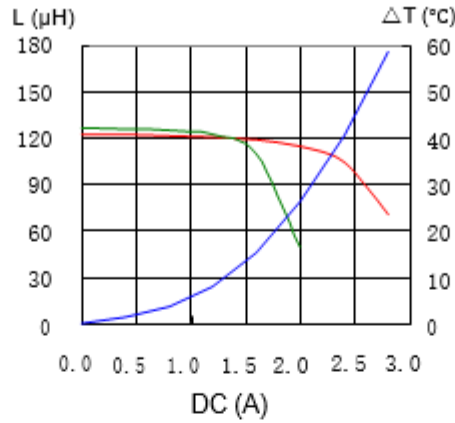

CDRH127LDNP-151MC

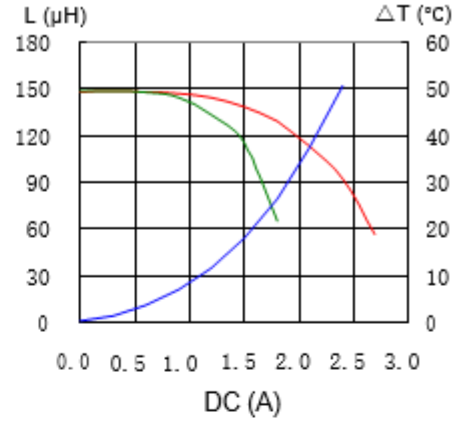

CDRH127LDNP-181MC

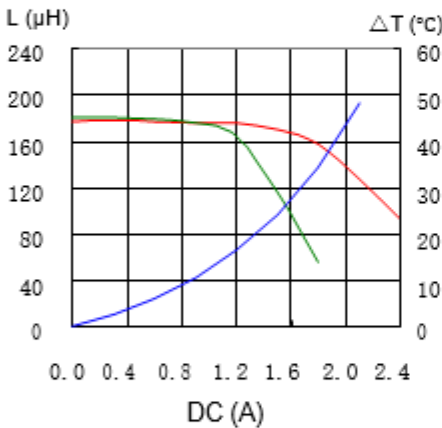

CDRH127LDNP-221MC

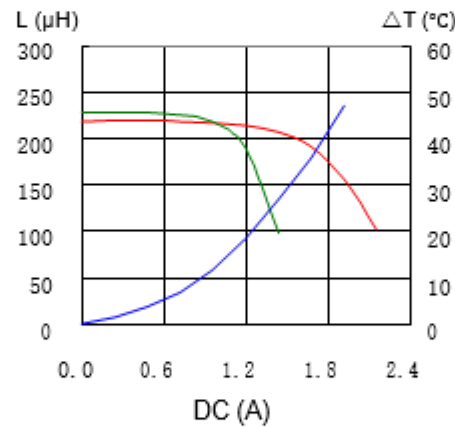

CDRH127LDNP-271MC

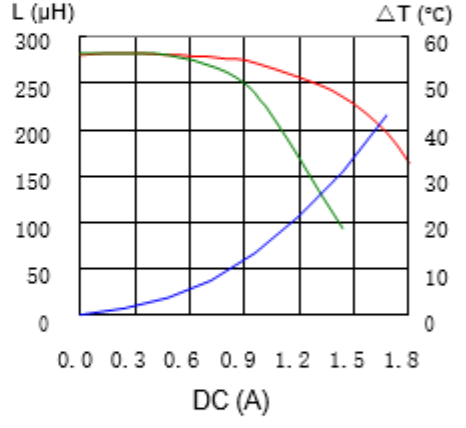

CDRH127LDNP-331MC

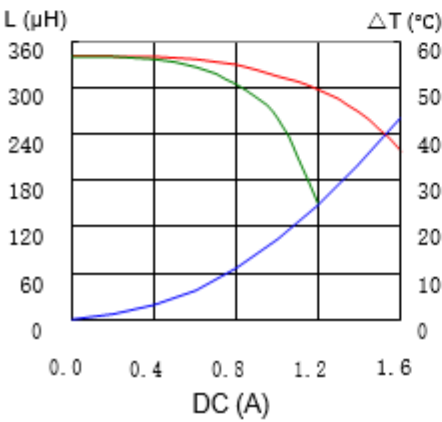

CDRH127LDNP-391MC

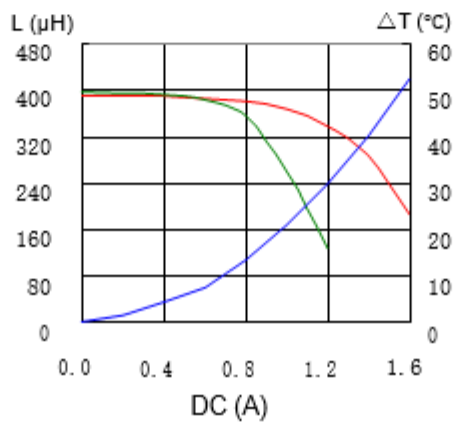

CDRH127LDNP-471MC

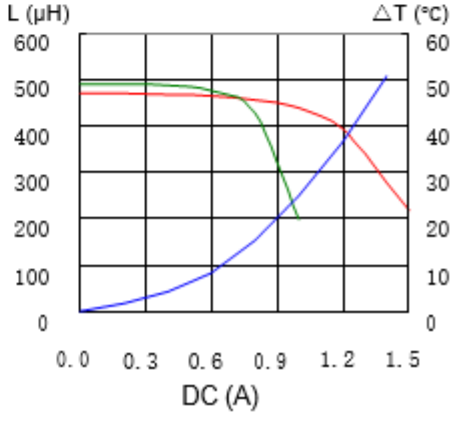

# SMD Power Inductor

## CDRH127/LD



 Recommended Type

— L (20°C)    — L (100°C)    —  $\Delta T$

CDRH127LDNP-561MC

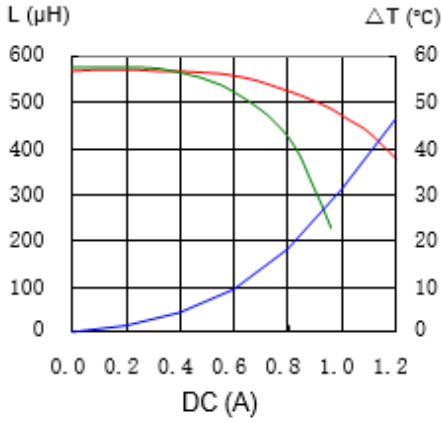

CDRH127LDNP-681MC

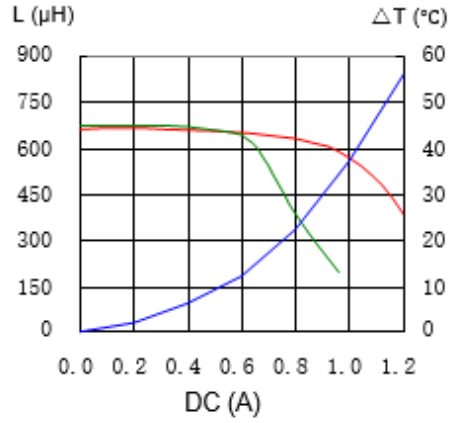

CDRH127LDNP-821MC

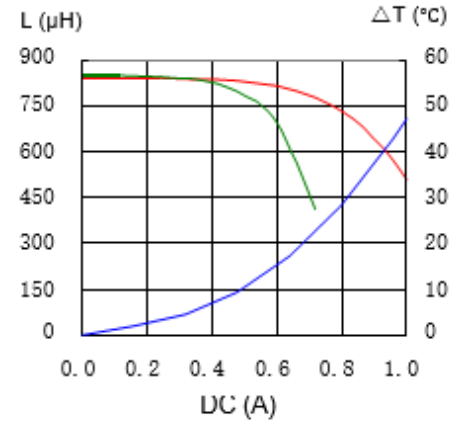

CDRH127LDNP-102MC

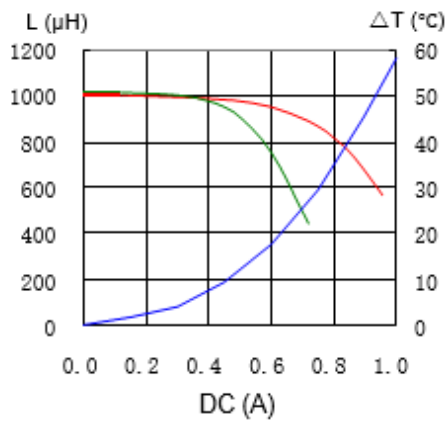

For sales office information, please [click here](#) to visit our website.