

### Features

- Protects one data line
- Ultra low leakage: nA level
- Operating voltage: 3.3V
- Ultra low clamping voltage
- Complies with following standards:
  - IEC 61000-4-2 (ESD) immunity test  
Air discharge:  $\pm 30\text{kV}$   
Contact discharge:  $\pm 30\text{kV}$
  - IEC61000-4-5 (Lightning) 8A (8/20 $\mu\text{s}$ )
- RoHS Compliant

### Applications

- Cellular Handsets and Accessories
- Personal Digital Assistants
- Notebooks and Handhelds
- Portable Instrumentation
- Digital Cameras
- Peripherals
- Audio Players
- Keypads, Side Keys, LCD Displays

### Mechanical Characteristics

- Package: DFN1006
- Lead Finish: Lead Free
- UL Flammability Classification Rating 94V-0
- Quantity Per Reel: 10,000pcs
- Reel Size: 7 inch
- Device Marking: B

### Absolute Maximum Ratings (Tamb=25°C unless otherwise specified)

Parameter	Symbol	Value	Unit
Peak Pulse Power (8/20 $\mu\text{s}$ )	Ppp	80	W
ESD per IEC 61000-4-2 (Air)	V <sub>ESD</sub>	$\pm 30$	Kv
ESD per IEC 61000-4-2 (Contact)		$\pm 30$	
Operating Temperature Range	T <sub>J</sub>	-55 to +125	°C
Storage Temperature Range	T <sub>STJ</sub>	-55 to +150	°C

### Dimensions DFN1006

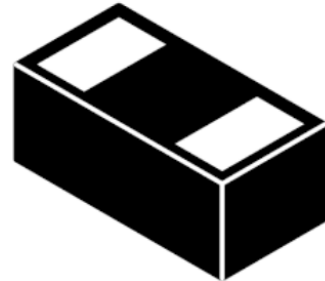

### Pin Configuration

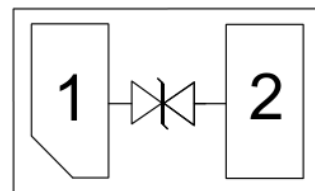

## Electrical Characteristics (TA=25°C unless otherwise specified)

Parameter	Symbol	Test Condition	Min	Typ	Max	Unit
Reverse Working Voltage	$V_{RWM}$				3.3	V
Breakdown Voltage	$V_{BR}$	$I_T = 1\text{mA}$	3.5			V
Reverse Leakage Current	$I_R$	$V_{RWM} = 3.3\text{V}$			0.5	$\mu\text{A}$
Clamping Voltage	$V_C$	$I_{PP} = 1\text{A}$ (8 x 20 $\mu\text{s}$ pulse)		6.5		V
Clamping Voltage	$V_C$	$I_{PP} = 8\text{A}$ (8 x 20 $\mu\text{s}$ pulse)			10	V
Junction Capacitance	$C_J$	$V_R = 0\text{V}$ , $f = 1\text{MHz}$		12		pF

## Typical Performance Characteristics ( $T_A=25^\circ\text{C}$ unless otherwise Specified)

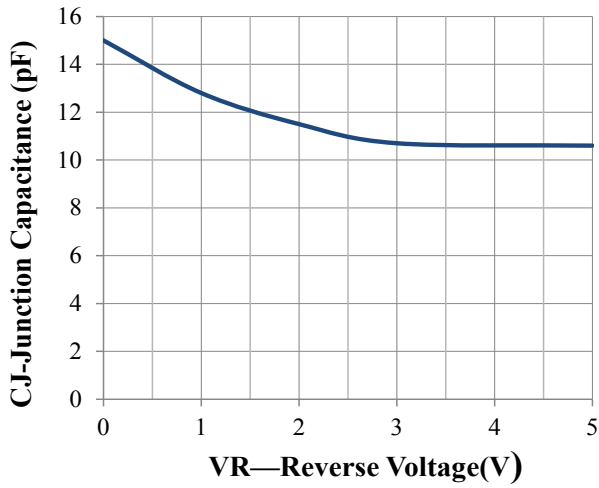

Junction Capacitance vs. Reverse Voltage

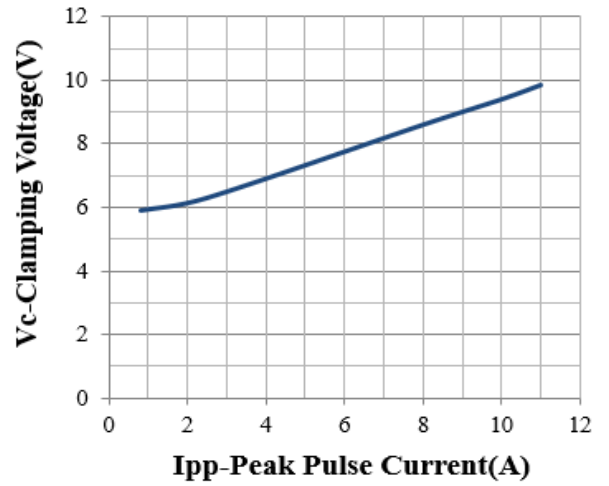

Clamping Voltage vs. Peak Pulse Current

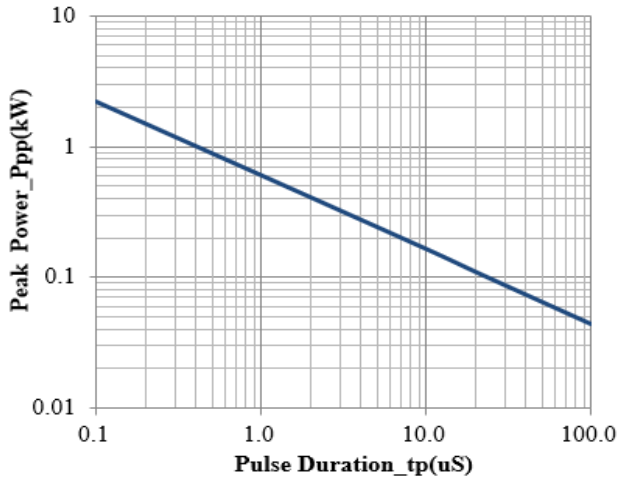

Peak Pulse Power vs. Pulse Time

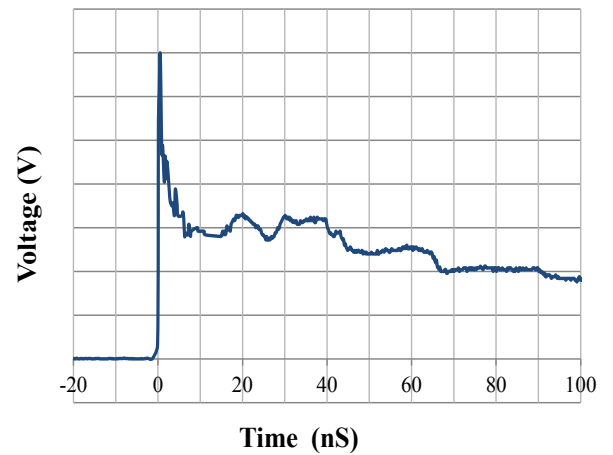

IEC61000-4-2 Pulse Waveform

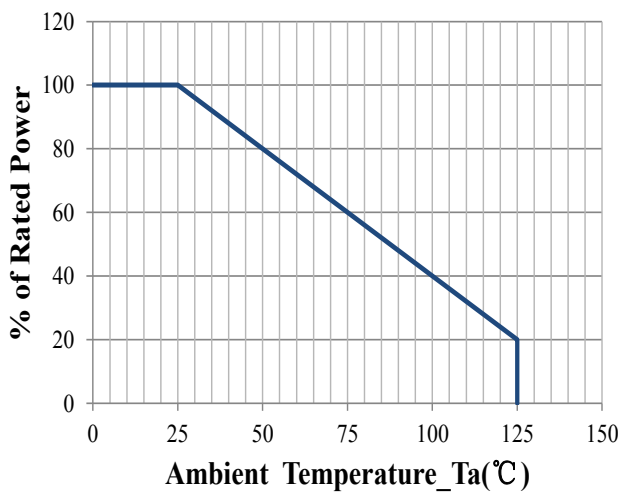

Power Derating Curve

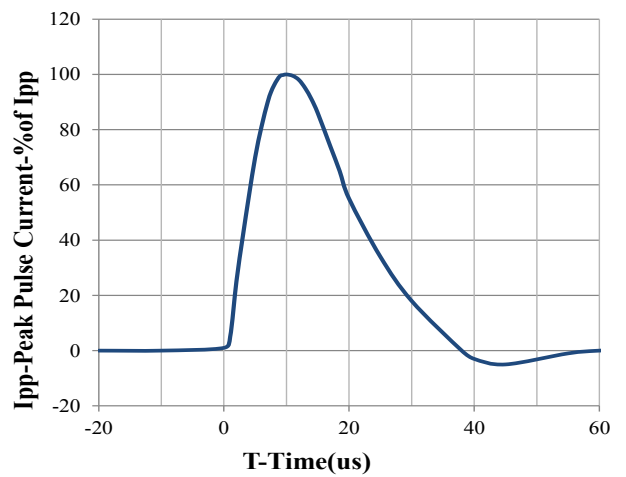

8 X 20us Pulse Waveform

## DFN1006 (0402)Package Outline Drawing

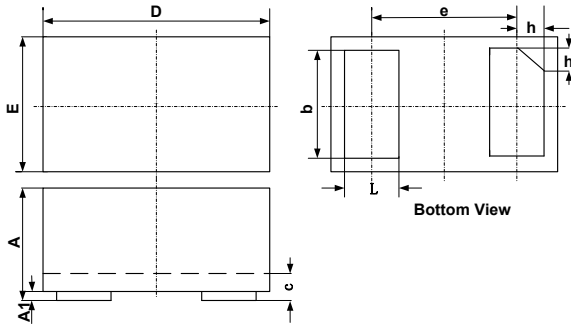

SYM	DIMENSIONS					
	MILLIMETERS			INCHES		
	MIN	NOM	MAX	MIN	NOM	MAX
A	0.45	0.50	0.55	0.018	0.020	0.022
A1	0.00	0.02	0.05	0.000	0.001	0.002
b	0.45	0.50	0.55	0.018	0.020	0.022
c	0.12	0.15	0.18	0.005	0.006	0.007
D	0.95	1.00	1.08	0.037	0.039	0.041
e	0.65 BSC			0.026 BSC		
E	0.55	0.60	0.68	0.022	0.024	0.026
L	0.20	0.25	0.30	0.008	0.010	0.012
h	0.07	0.12	0.17	0.003	0.005	0.007

## Suggested Land Pattern

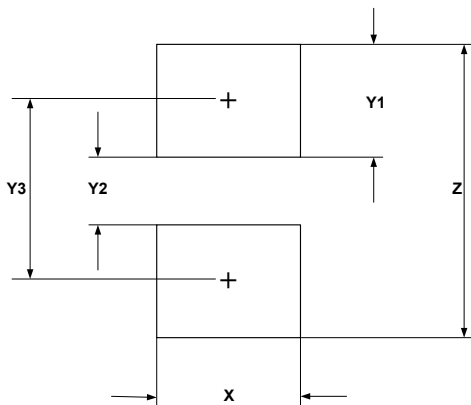

SYM	DIMENSIONS	
	MILLIMETERS	INCHES
X	0.60	0.024
Y1	0.50	0.020
Y2	0.30	0.012
Y3	0.80	0.032
Z	1.30	0.052