

Features

- Protects one data line
- Ultra low leakage: nA level
- Operating voltage: 3.3V
- Ultra low clamping voltage
- Complies with following standards:
 - IEC 61000-4-2 (ESD) immunity test
Air discharge: $\pm 30\text{kV}$
Contact discharge: $\pm 30\text{kV}$
 - IEC61000-4-5 (Lightning) 8A (8/20 μs)
- RoHS Compliant

Applications

- Cellular Handsets and Accessories
- Personal Digital Assistants
- Notebooks and Handhelds
- Portable Instrumentation
- Digital Cameras
- Peripherals
- Audio Players
- Keypads, Side Keys, LCD Displays

Mechanical Characteristics

- Package: DFN1006
- Lead Finish: Lead Free
- UL Flammability Classification Rating 94V-0
- Quantity Per Reel: 10,000pcs
- Reel Size: 7 inch
- Device Marking: B

Absolute Maximum Ratings (Tamb=25°C unless otherwise specified)

| Parameter | Symbol | Value | Unit |
|--|------------------|-------------|------|
| Peak Pulse Power (8/20 μs) | Ppp | 80 | W |
| ESD per IEC 61000-4-2 (Air) | V _{ESD} | ± 30 | Kv |
| ESD per IEC 61000-4-2 (Contact) | | ± 30 | |
| Operating Temperature Range | T _J | -55 to +125 | °C |
| Storage Temperature Range | T _{STJ} | -55 to +150 | °C |

Dimensions DFN1006

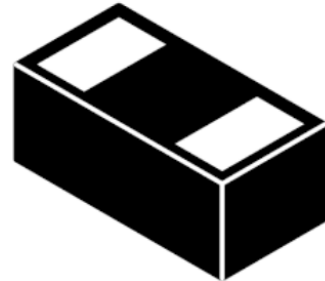

Pin Configuration

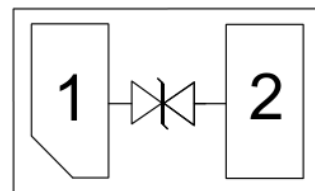

Electrical Characteristics (TA=25°C unless otherwise specified)

| Parameter | Symbol | Test Condition | Min | Typ | Max | Unit |
|-------------------------|-----------|---|-----|-----|-----|---------------|
| Reverse Working Voltage | V_{RWM} | | | | 3.3 | V |
| Breakdown Voltage | V_{BR} | $I_T = 1\text{mA}$ | 3.5 | | | V |
| Reverse Leakage Current | I_R | $V_{RWM} = 3.3\text{V}$ | | | 0.5 | μA |
| Clamping Voltage | V_C | $I_{PP} = 1\text{A}$ (8 x 20 μs pulse) | | 6.5 | | V |
| Clamping Voltage | V_C | $I_{PP} = 8\text{A}$ (8 x 20 μs pulse) | | | 10 | V |
| Junction Capacitance | C_J | $V_R = 0\text{V}$, $f = 1\text{MHz}$ | | 12 | | pF |

Typical Performance Characteristics ($T_A=25^\circ\text{C}$ unless otherwise Specified)

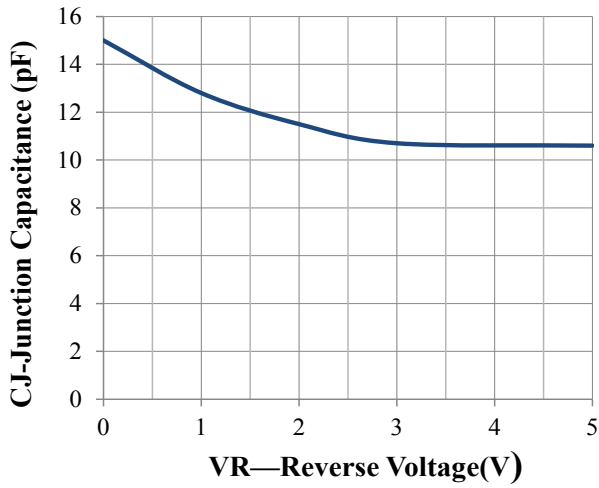

Junction Capacitance vs. Reverse Voltage

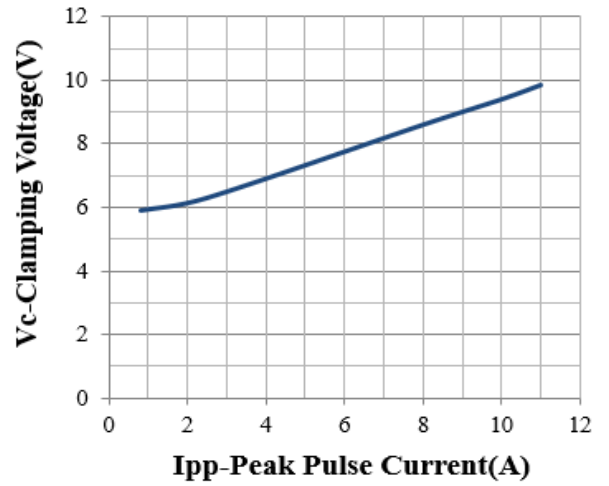

Clamping Voltage vs. Peak Pulse Current

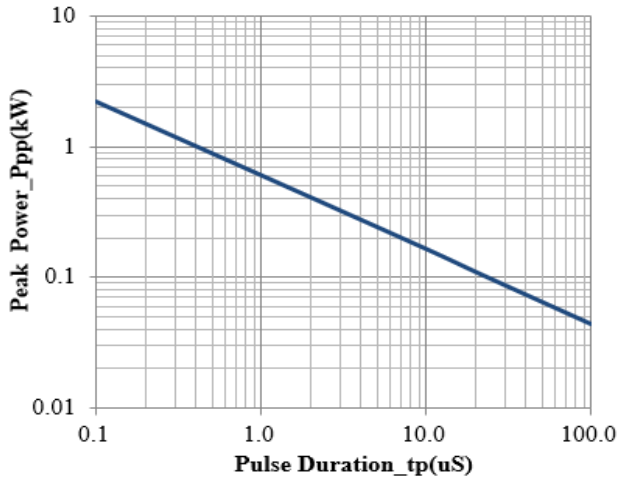

Peak Pulse Power vs. Pulse Time

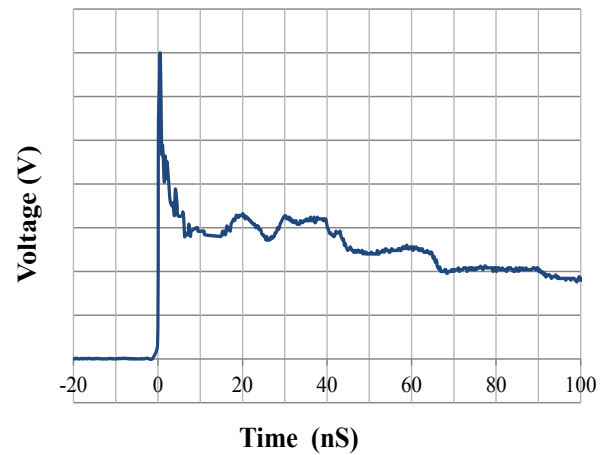

IEC61000-4-2 Pulse Waveform

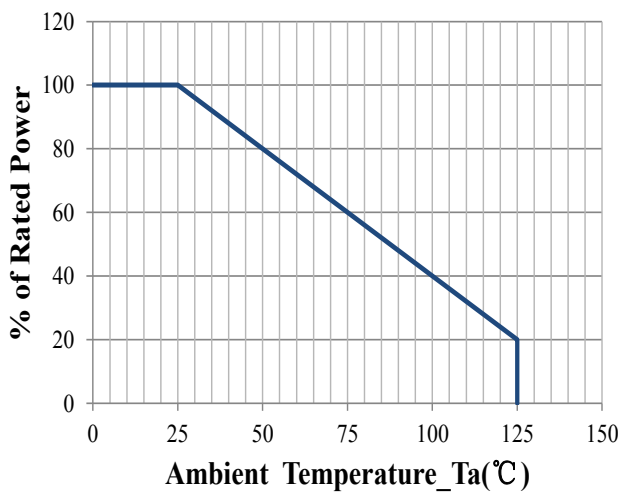

Power Derating Curve

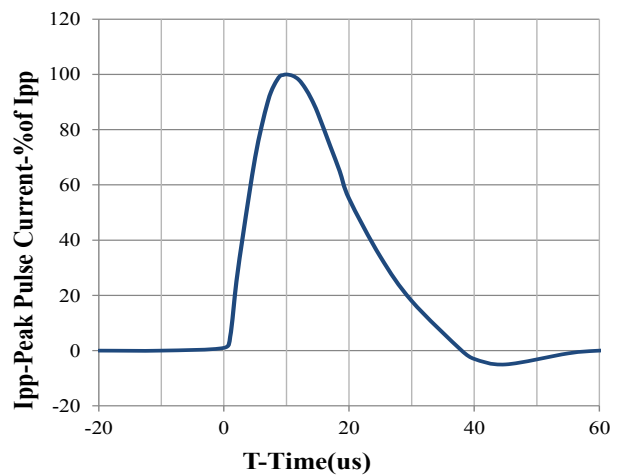

8 X 20us Pulse Waveform

DFN1006 (0402)Package Outline Drawing

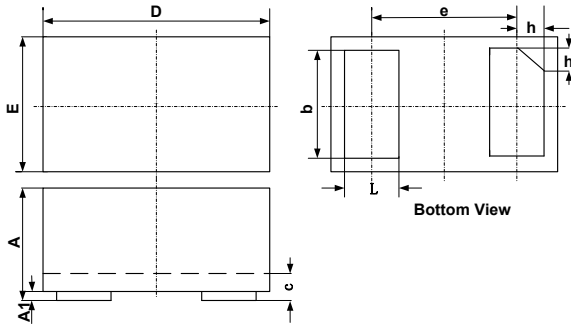

| SYM | DIMENSIONS | | | | | |
|-----|-------------|------|------|-----------|-------|-------|
| | MILLIMETERS | | | INCHES | | |
| | MIN | NOM | MAX | MIN | NOM | MAX |
| A | 0.45 | 0.50 | 0.55 | 0.018 | 0.020 | 0.022 |
| A1 | 0.00 | 0.02 | 0.05 | 0.000 | 0.001 | 0.002 |
| b | 0.45 | 0.50 | 0.55 | 0.018 | 0.020 | 0.022 |
| c | 0.12 | 0.15 | 0.18 | 0.005 | 0.006 | 0.007 |
| D | 0.95 | 1.00 | 1.08 | 0.037 | 0.039 | 0.041 |
| e | 0.65 BSC | | | 0.026 BSC | | |
| E | 0.55 | 0.60 | 0.68 | 0.022 | 0.024 | 0.026 |
| L | 0.20 | 0.25 | 0.30 | 0.008 | 0.010 | 0.012 |
| h | 0.07 | 0.12 | 0.17 | 0.003 | 0.005 | 0.007 |

Suggested Land Pattern

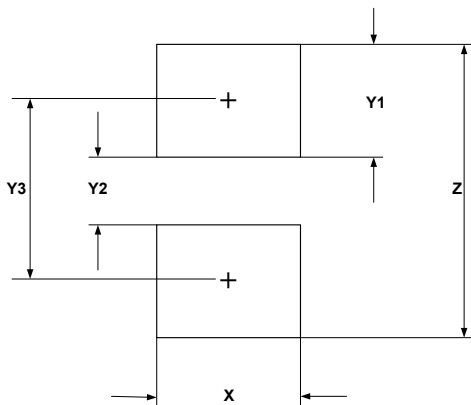

| SYM | DIMENSIONS | |
|-----|-------------|--------|
| | MILLIMETERS | INCHES |
| X | 0.60 | 0.024 |
| Y1 | 0.50 | 0.020 |
| Y2 | 0.30 | 0.012 |
| Y3 | 0.80 | 0.032 |
| Z | 1.30 | 0.052 |