

Features

- Protects one data line
- Ultra low leakage: nA level
- Operating voltage: 3.3V
- Ultra low clamping voltage
- Complies with following standards:
 - IEC 61000-4-2 (ESD) immunity test
Air discharge: $\pm 30\text{kV}$
Contact discharge: $\pm 30\text{kV}$
 - IEC61000-4-5 (Lightning) 8A (8/20 μs)
- RoHS Compliant

Applications

- Cellular Handsets and Accessories
- Personal Digital Assistants
- Notebooks and Handhelds
- Portable Instrumentation
- Digital Cameras
- Peripherals
- Audio Players
- Keypads, Side Keys, LCD Displays

Dimensions DFN1006

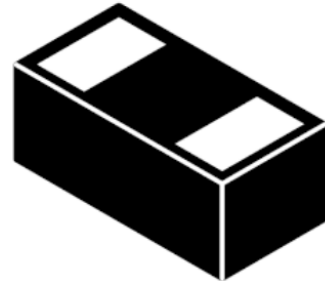

Pin Configuration

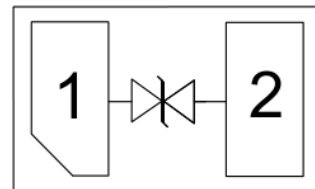

Mechanical Characteristics

- Package: DFN1006
- Lead Finish: Lead Free
- UL Flammability Classification Rating 94V-0
- Quantity Per Reel: 10,000pcs
- Reel Size: 7 inch
- Device Marking: B

Absolute Maximum Ratings (T_{amb}=25°C unless otherwise specified)

Parameter	Symbol	Value	Unit
Peak Pulse Power (8/20 μs)	P _{pp}	80	W
ESD per IEC 61000-4-2 (Air)	V _{ESD}	± 30	Kv
ESD per IEC 61000-4-2 (Contact)		± 30	
Operating Temperature Range	T _J	-55 to +125	°C
Storage Temperature Range	T _{STJ}	-55 to +150	°C

Electrical Characteristics (TA=25°C unless otherwise specified)

Parameter	Symbol	Test Condition	Min	Typ	Max	Unit
Reverse Working Voltage	V_{RWM}				3.3	V
Breakdown Voltage	V_{BR}	$I_T = 1\text{mA}$	3.5			V
Reverse Leakage Current	I_R	$V_{RWM} = 3.3\text{V}$			0.5	μA
Clamping Voltage	V_C	$I_{PP} = 1\text{A}$ (8 x 20 μs pulse)		6.5		V
Clamping Voltage	V_C	$I_{PP} = 8\text{A}$ (8 x 20 μs pulse)			10	V
Junction Capacitance	C_J	$V_R = 0\text{V}$, $f = 1\text{MHz}$		12		pF

Typical Performance Characteristics ($T_A=25^\circ\text{C}$ unless otherwise Specified)

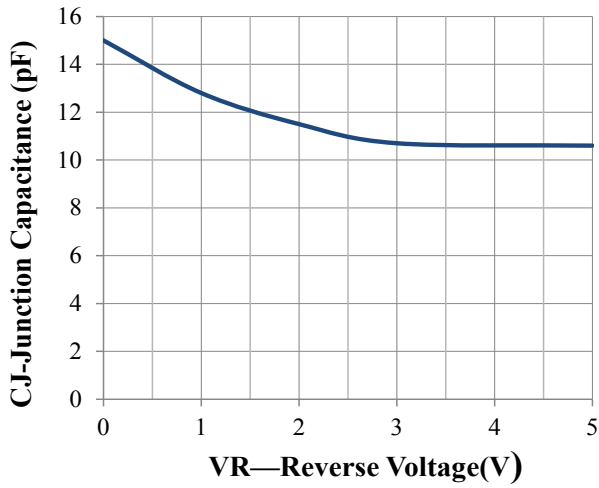

Junction Capacitance vs. Reverse Voltage

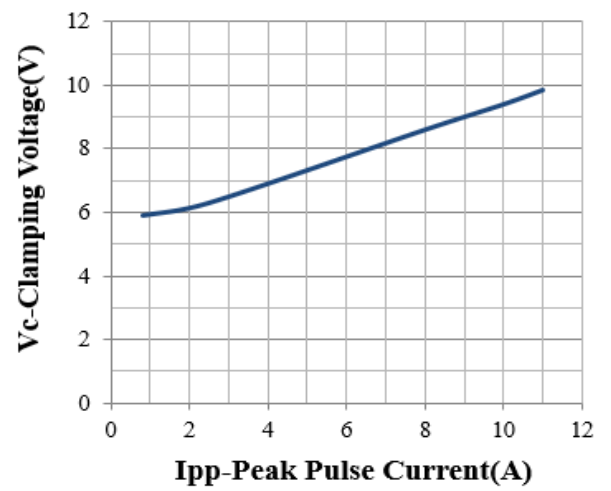

Clamping Voltage vs. Peak Pulse Current

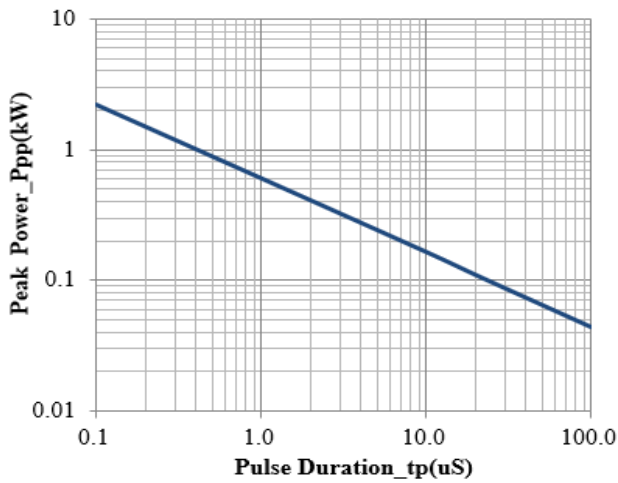

Peak Pulse Power vs. Pulse Time

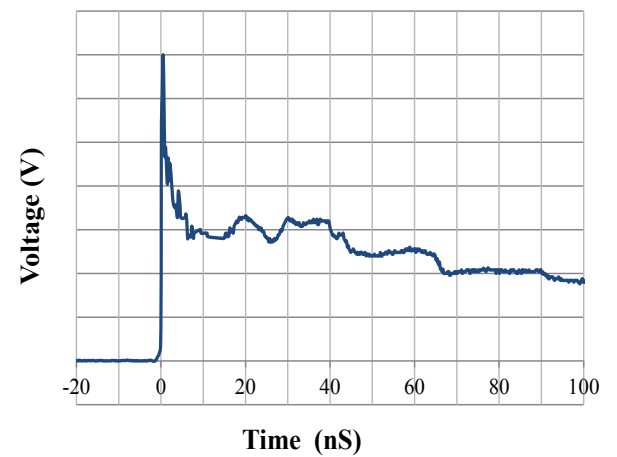

IEC61000-4-2 Pulse Waveform

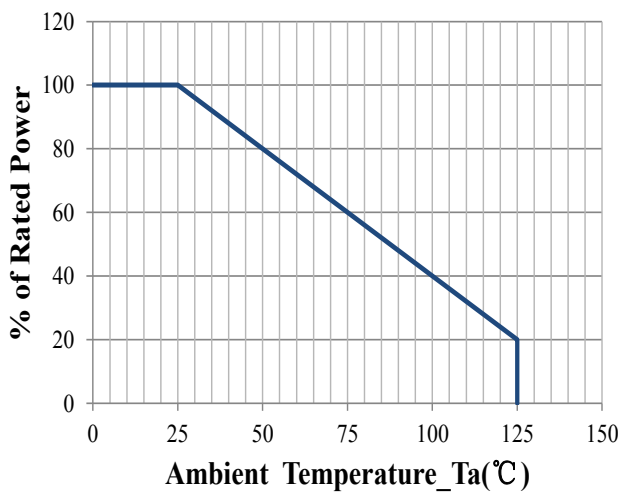

Power Derating Curve

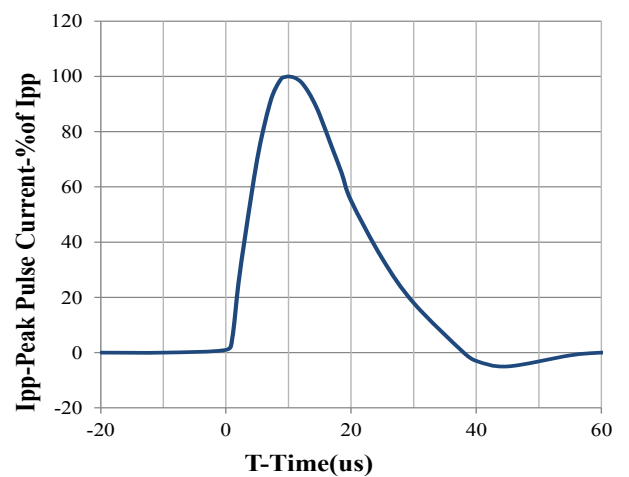

8 X 20us Pulse Waveform

DFN1006 (0402)Package Outline Drawing

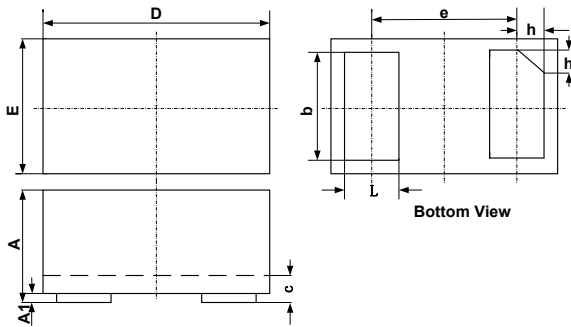

SYM	DIMENSIONS					
	MILLIMETERS			INCHES		
	MIN	NOM	MAX	MIN	NOM	MAX
A	0.45	0.50	0.55	0.018	0.020	0.022
A1	0.00	0.02	0.05	0.000	0.001	0.002
b	0.45	0.50	0.55	0.018	0.020	0.022
c	0.12	0.15	0.18	0.005	0.006	0.007
D	0.95	1.00	1.08	0.037	0.039	0.041
e	0.65 BSC			0.026 BSC		
E	0.55	0.60	0.68	0.022	0.024	0.026
L	0.20	0.25	0.30	0.008	0.010	0.012
h	0.07	0.12	0.17	0.003	0.005	0.007

Suggested Land Pattern

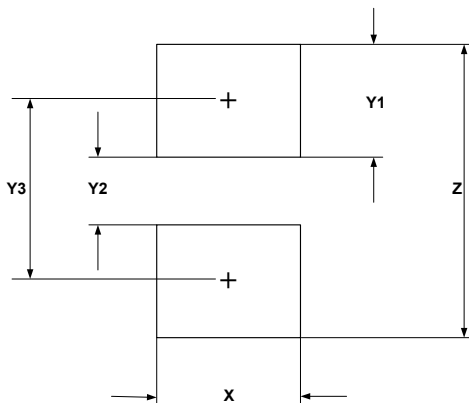

SYM	DIMENSIONS	
	MILLIMETERS	INCHES
X	0.60	0.024
Y1	0.50	0.020
Y2	0.30	0.012
Y3	0.80	0.032
Z	1.30	0.052