

### 1. Scope

This specification applies to the FTW1608FE□□□□T of Wire Wound Chip Ferrite Inductor.

### 2. Product Description and Identification (Part Number)

1) Description

Wire Wound Chip Ferrite Inductor, 1608, XXX  $\mu\text{H} \pm \text{XX}\%$  @XXXMHz, XXX $\Omega$ , XXX mA

2) Product Identification (Part Number)

3)

FTW  
①
1608  
②
F  
③
E  
④
□□□  
⑤
□  
⑥
I  
⑦

① Type	
FTW	Wire Wound Chip Radio Frequency Inductor

② External Dimensions [L X W] (mm)	
1608	1.6 X 0.8

③ Material Code	
F	Ferrite

④ Internal Code	
E	Internal Code

⑤ Nominal Inductance ( $\mu\text{H}$ )	
Example	Nominal Value
2R2	2.2
100	10

⑥ Inductance Tolerance	
K	$\pm 10\%$
M	$\pm 20\%$

⑦ Packing	
B	Bulk Package
T	Tape & Reel

### 3. Electrical Characteristics

Please refer to Item 5.

- Operating and storage temperature range (individual chip without packing, self-temperature rise is not included):  $-40^{\circ}\text{C}$  to  $+85^{\circ}\text{C}$
- Storage temperature range (packaging conditions):  $-10^{\circ}\text{C} \sim +40^{\circ}\text{C}$  and RH 70% (Max.)

### 4. Shape and Dimensions

- Dimensions: See the following.

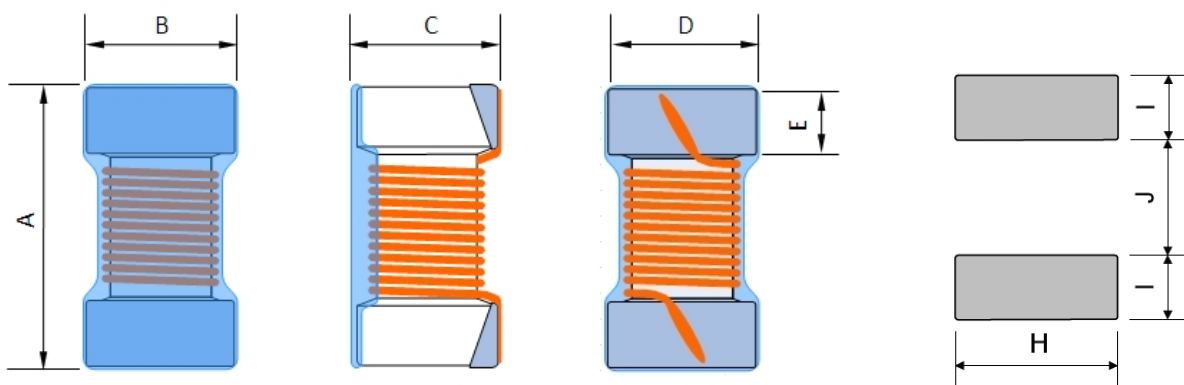

Unit: mm

A Max.	B Max.	C Max.	D Typ.	E Ref.	H Ref.	I Ref.	J Ref.
1.80	1.20	1.00	0.92	0.30	1.15	0.64	0.64

- Electrode Coplanarity: 0.1mm Max.

3) Structure: See the following.

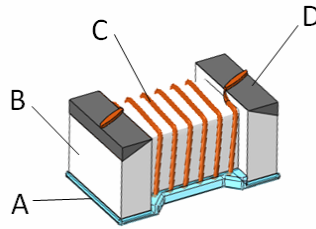

No.	Components	Material
A	Coating	Ultraviolet epoxy resin
B	Core	Ferrite
C	Wire	Polyurethane system enameled copper wire
D	Electrodes	Ag/Ag-Pd with Ni and Sn plating

#### 5. Electrical Characteristics

##### I.FTW1608FE□□□T Series

Part Number	Inductance	Tolerance	Q Factor	L/Q Test Freq.	DC Resistance	Typ. Saturation Current	Typ. Rated Current	Typ. Self-resonant Frequency
Units	μH	-	-	MHz	Ω	mA	mA	MHz
Symbol	L	-	Q	Freq.	DCR	IDC	I <sub>rms</sub>	SRF
FTW1608FE2R2□T	2.2	K,M	16	7.9	0.56±30%	600	580	103
FTW1608FE4R7□T	4.7	K,M	16	7.9	0.79±30%	400	420	51
FTW1608FE6R8□T	6.8	K,M	16	7.9	1.50±30%	340	340	43
FTW1608FE100□T	10	K,M	14	2.5	1.85±30%	280	280	36
FTW1608FE150□T	15	K,M	14	2.5	2.60±30%	240	240	29
FTW1608FE220□T	22	K,M	14	2.5	2.80±30%	200	200	24
FTW1608FE470□T	47	K,M	11	2.5	6.65±30%	100	100	14

## 6. Test and Measurement Procedures

### 6.1 Test Conditions

Unless otherwise specified, the standard atmospheric conditions for measurement/test as:

- a. Ambient Temperature:  $20 \pm 15^{\circ}\text{C}$
- b. Relative Humidity:  $65\% \pm 20\%$
- c. Air Pressure: 86 KPa to 106 KPa

If any doubt on the results, measurements/tests should be made within the following limits:

- a. Ambient Temperature:  $20 \pm 2^{\circ}\text{C}$
- b. Relative Humidity:  $65\% \pm 5\%$
- c. Air Pressure: 86KPa to 106 KPa

### 6.2 Visual Examination

- a. Inspection Equipment: 30X magnifier

### 6.3 Electrical Test

#### 6.3.1 DC Resistance (DCR)

- a. Refer to **Item 5**.
- b. Test equipment: HIOKI3540 or equivalent.

#### 6.3.2 Inductance (L)

- a. Refer to **Item 5**.
- b. Test equipment: Agilent4287A+Agilent16197A or equivalent.
- c. Test signal: -13dBm or 10mA
- d. Test frequency refers to Item 3.

#### 6.3.3 Q Factor (Q)

- a. Refer to **Item 5**.
- b. Test equipment: Agilent4287A+Agilent16197A or equivalent.
- c. Test signal: -13dBm or 10mA
- d. Test frequency refers to **Item 5**.

#### 6.3.4 Self-Resonant Frequency (SRF)

- a. Refer to **Item 5**.
- b. Test equipment: Agilent4991B+Agilent16197A and HP 8753E or equivalent.
- c. Test signal: -20dBm or 50mV

#### 6.3.5 Saturation Current (IDC)

- a. Refer to **Item 5**.
- b. Test equipment : Electric Power, Electric current meter, Agilent4991A+Agilent16197A or equivalent.
- c. Measurement method :
  1. Set test current to be 0 mA.
  2. Measure initial chip inductance.
  3. Gradually increase voltage and measure chip inductance for corresponding current.
- d. Definition of Saturation Current (IDC): IDC is direct electric current as chip inductance drop just **10%** from its value without current.

#### 6.3.6 Rated Current (Irms)

- e. Refer to **Item 5**.
- f. Test equipment (see **Fig.6.3.4-1**): Electric Power, Electric current meter, Thermometer.
- g. Measurement method (see **Fig. 6.3.4-1**):
  1. Set test current to be 0 mA.
  2. Measure initial temperature of chip surface.
  3. Gradually increase voltage and measure chip temperature for corresponding current.
- h. Definition of Rated Current (Irms): Irms is direct electric current as chip surface temperature rose just **15°C** against chip initial surface temperature ( $T_a$ ) (see **Fig. 6.3.4-2**).

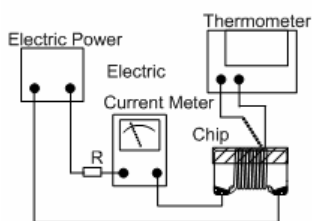

Fig. 6.3.4-1

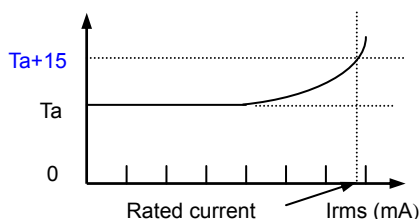
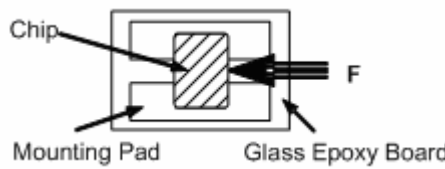
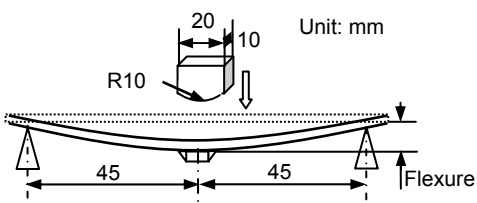
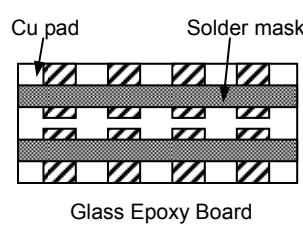
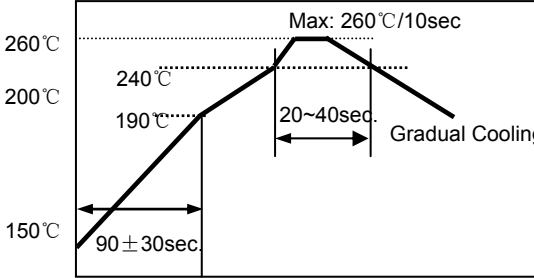
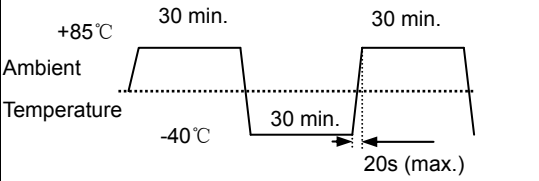

Fig. 6.3.4-2

### 6.4 Reliability Test

Items	Requirements	Test Methods and Remarks
6.4.1 Terminal Strength	No removal or split of the termination or other defects shall occur.  	<ol style="list-style-type: none"> <li>① Solder the inductor to the testing jig (glass epoxy board) using eutectic solder. Then apply a force in the direction of the arrow.</li> <li>② 5N force.</li> <li>③ Keep time: 10±1s</li> <li>④ Speed: 1.0 mm/s.</li> </ol>
6.4.2 Resistance to Flexure	No visible mechanical damage.  	<ol style="list-style-type: none"> <li>① Solder the inductor to the test jig. Using a eutectic solder. Then apply a force in the direction shown as left.</li> <li>② Flexure: 2mm</li> <li>③ Pressurizing Speed: 0.5mm/sec.</li> <li>④ Keep time: 5sec.</li> </ol>
6.4.3 Vibration	<ol style="list-style-type: none"> <li>① No visible mechanical damage.</li> <li>② Inductance change: within ±5%</li> </ol> 	<ol style="list-style-type: none"> <li>① Solder the inductor to the testing jig (glass epoxy board) using eutectic solder.</li> <li>② The inductor shall be subjected to a simple harmonic motion having total amplitude of 1.5mm, the frequency being varied uniformly between the approximate limits of 10 and 55 Hz.</li> <li>③ The frequency range from 10 to 55 Hz and return to 10 Hz shall be traversed in approximately 1 minute. This motion shall be applied for a period of 2 hours in each 3 mutually perpendicular directions (total of 6 hours)</li> </ol>
6.4.4 Dropping	<ol style="list-style-type: none"> <li>① No visible mechanical damage.</li> <li>② Inductance change: within ±5%</li> </ol>	Drop chip inductor 10 times on a concrete floor from a height of 100 cm.
6.4.5 Temperature coefficient	Inductance change: within ±5%	<ol style="list-style-type: none"> <li>① Between -40℃ and +85℃</li> <li>② With a reference value of +20℃</li> </ol>
6.4.6 Solderability	90% or more of electrode area shall be Coated by new solder.	<ol style="list-style-type: none"> <li>① Electrode of the coil shall be immersed in flux for 5 to 10 Seconds.</li> <li>② The coil shall be immersed in solder bath at a temperature of 240±5℃, Duration for 3±0.5 seconds.</li> <li>③ Solder: Sn/3.0Ag/0.5Cu</li> <li>④ Flux: 25% Resin and 75% ethanol in weight.</li> </ol>

6.4.7 Resistance to Soldering Heat	① No visible mechanical damage. ② Inductance change: within $\pm 5\%$	Re-flowing Profile: 
6.4.8 Thermal Shock	③ No visible mechanical damage. ④ Inductance change: within $\pm 5\%$ 	① Temperature, Time: -40°C for 30±3 min→+85°C for 30±3min ② Transforming interval: 20s (max.) ③ Tested cycle: 100 cycles ④ The chip shall be stabilized at normal condition for 1~2 hours before measuring.
6.4.9 Resistance to Low Temperature	① No visible mechanical damage. ② Inductance change: within $\pm 5\%$	① Temperature: $-40\pm 2^\circ\text{C}$ ② Duration: 1000 <sup>+24</sup> hours ③ The chip shall be stabilized at normal condition for 1~2 hours before measuring.
6.4.10 Resistance to High Temperature	① No mechanical damage. ② Inductance change: within $\pm 5\%$	① Temperature: $85\pm 2^\circ\text{C}$ ② Duration: 1000 <sup>+24</sup> hours ③ The chip shall be stabilized at normal condition for 1~2 hours before measuring.
6.4.11 Damp Heat (Steady States)	① No mechanical damage. ② Inductance change: within $\pm 5\%$	① Temperature: $60\pm 2^\circ\text{C}$ , Humidity: 90% to 95% RH ② Duration: 1000 <sup>+24</sup> hours ③ The chip shall be stabilized at normal condition for 1~2 hours before measuring.

## 7. Packaging and Storage

### 7.1 Packaging

There is one type of packaging for the chip inductors. Please specify the packing code when ordering.

Tape Carrier Packaging:

Packaging code: T

- i. Tape carrier packaging are specified in attached figure Fig.7.1-1~4
- ii. Tape carrier packaging quantity please see the following table:

Type	1608
Tape	Punched Tape
Quantity	3K

(1) Taping Drawings (Unit: mm)

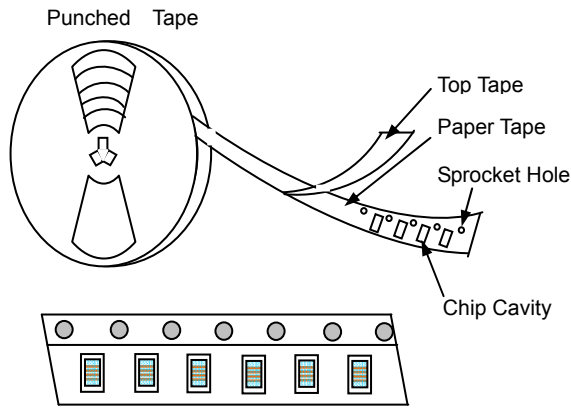

Fig. 7.1-1

**Remark:** The sprocket holes are to the right as the tape is pulled toward the user.

(2) Taping Dimensions (Unit: mm)

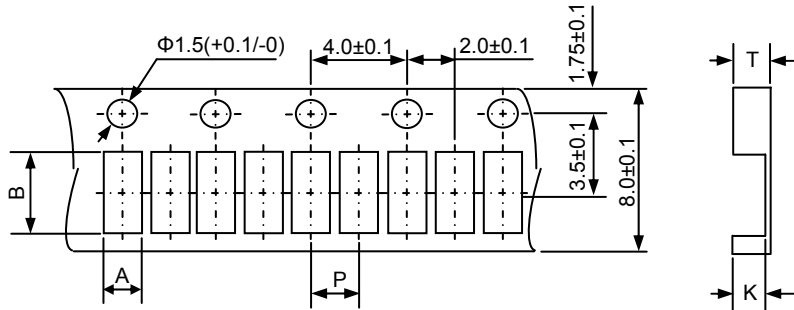

Fig. 7.1-2

Type	A	B	P	K	T
1608	$1.30 \pm 0.10$	$1.90 \pm 0.10$	$4.0 \pm 0.05$	$1.08 \pm 0.10$	$1.12 \pm 0.10$

(3) Leader and blank portion

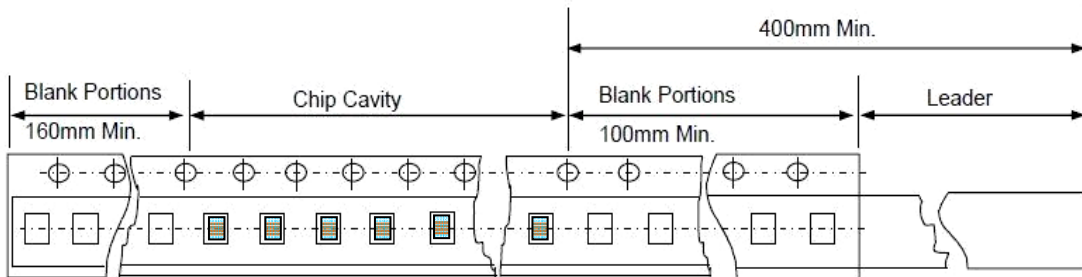

Fig. 7.1-3

(4) Reel Dimensions (Unit: mm)

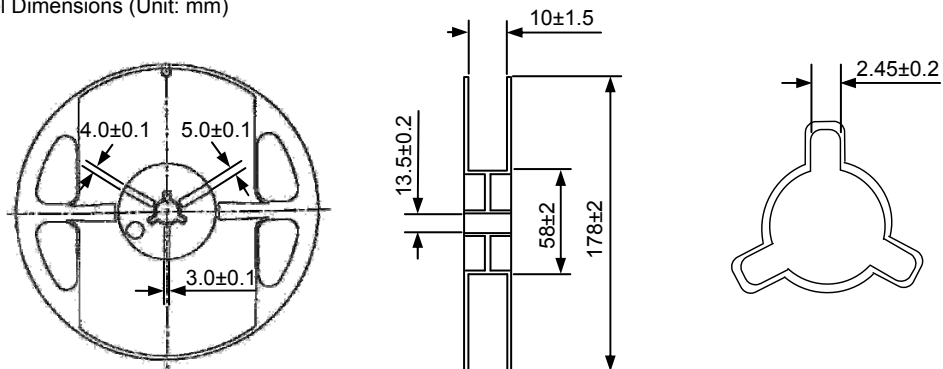

Fig. 7.1-4

(5) Peeling off force: 10gf to 70gf in the direction show below.

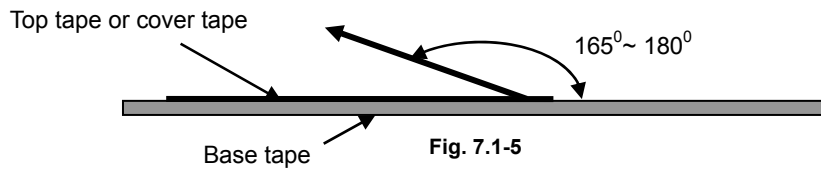

Fig. 7.1-5

## 7.2 Storage

- The solderability of the external electrode may be deteriorated if packages are stored where they are exposed to high humidity. Package must be stored at 40°C or less and 70% RH or less.
- The solderability of the external electrode may be deteriorated if packages are stored where they are exposed to dust of harmful gas (e.g. HCl, sulfurous gas of H<sub>2</sub>S)
- Packaging material may be deformed if package are stored where they are exposed to heat of direct sunlight.
- Minimum packages, such as polyvinyl heat-seal packages shall not be opened until they are used. If opened, use the reels as soon as possible.
- Solderability shall be guaranteed for 12 months from the date of delivery on condition that they are stored at the environment specified in specification. For those parts, which passed more than 12months shall be checked solder-ability before use.

## 8. Warning and Attentions

### 8.1 Precautions on Use

- Always wear static control bands to protect against ESD.
- Any devices used (soldering iron, measuring instruments) should be properly grounded.
- Use non-magnetic tweezers when handing the chips.
- Pre-heating when soldering, and refer to the recommended condition specified in specification.
- Don't apply current in excess of the rated current value. It may cause damage to components due to over-current.
- Keep clear of anything that may generate magnetic fields such as speakers, coils.
- When soldering, the electrical characteristics may be varied due to hot energy and mechanical stress.
- When coating products with resin, the relatively high resin curing stress may change the electrical characteristics. For exterior coating, select resin carefully so that electrical and mechanical performance of the product is not affected. Before using, please evaluate reliability with the product mounted in your application set.
- When mount chips with adhesive in preliminary assembly, do appropriate check before the soldering stage, i.e., the size of land pattern, type of adhesive, amount applied, hardening of the adhesive on proper usage and amounts of adhesive to use.
- Mounting density: Add special attention to radiating heat of products when mounting other components nearby. The excessive heat by other products may cause deterioration at joint of this product with substrate.
- Since some products are constructed like an open magnetic circuit, narrow spacing between components may cause magnetic coupling.
- Please do not give the product any excessive mechanical shocks in transportation.
- Please do not touch wires by sharp terminals such as tweezers to avoid causing any damage to wires.
- Please do not add any shock and power to the soldered product to avoid causing any damage to chip body.
- Please do not touch the electrodes by naked hand as the solderability of the external electrodes may deteriorate by grease or oil on the skin.

### 8.2 PCB Bending Design

The following shall be considered when designing and laying out PCB's.

- PCB shall be designed so that products are not subjected to the mechanical stress from board warp or deflection.

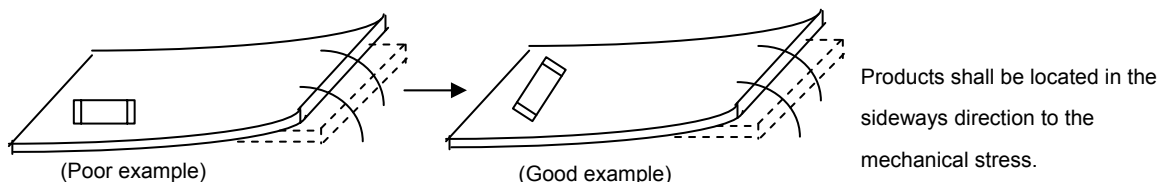

- Products location on PCB separation.

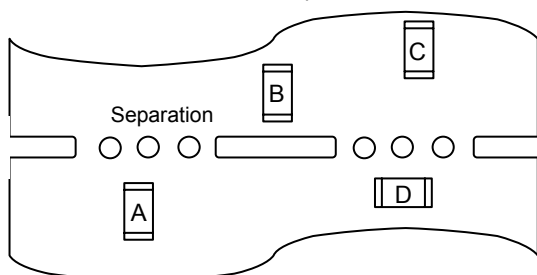

Product shall be located carefully because they may be subjected to the mechanical stress in order of A>C=B>D.

- c. When splitting the PCB board, or insert (remove) connector, or fasten thread after mounting components, care is required so as not to give any stress of deflection or twisting to the board. Because mechanical force may cause deterioration of the bonding strength of electrode and solder, even crack of product body. Board separation should not be done manually, but by using appropriate devices.

### 8.3 Recommended PCB Design for SMT Land-Patterns

When chips are mounted on a PCB, the amount of solder used (size of fillet) and the size of PCB Land-Patterns can directly affect chip performance (such as Q). And they can also cause other soldering question (such as offset and side lap). Therefore, the following items must be carefully considered in the design of solder land patterns.

- a. Please use the PCB pad and solder paste we recommend, and contact us in advance if they need to be changed.
- b. Please use flux contained with resin since the highly acidic (Chlorine content more than 0.2 wt%) or water-soluble one could damage the insulation film of wires, then causing short circuit of parts.
- c. The amount of solder applied can affect the ability of chips to withstand mechanical stresses which may lead to breaking or cracking. Therefore, when designing land-patterns it is necessary to consider the appropriate size and configuration of the solder pads which in turn determines the amount of solder necessary to form the fillets.
- d. When more than one part is jointly soldered onto the same land or pad, the pad must be designed that each component's soldering point is separated by solder-resist.

Recommended land dimensions please refer to product specification.

## 9. Recommended Soldering Technologies

This product is only for reflow soldering and iron soldering.

### 9.1 Re-flowing Profile

- △ Preheat condition: 150~200°C/60~120sec.
- △ Allowed time above 217°C: 60~90sec.
- △ Max temp: 260°C
- △ Max time at max temp: 10sec.
- △ Solder paste: Sn/3.0Ag/0.5Cu
- △ Allowed Reflow time: 2 times max.

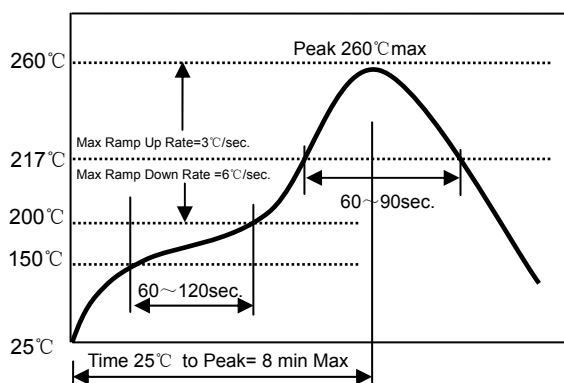

[Note: The reflow profile in the above table is only for qualification and is not meant to specify board assembly profiles. Actual board assembly profiles must be based on the customer's specific board design, solder paste and process, and should not exceed the parameters as the Reflow profile shows.]

### 9.2 Iron Soldering Profile

- △ Iron soldering power: 30W Max.
- △ Preheat condition: 150°C/60sec.
- △ Soldering tip temperature: 350°C Max.
- △ Soldering time: 3sec. Max.
- △ Solder paste: Sn/3.0Ag/0.5Cu
- △ Iron Soldering time: 1 time max.

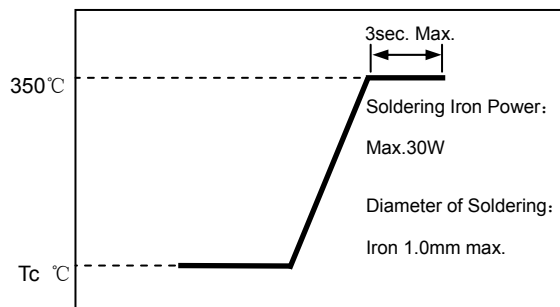

[Note: Take care not to apply the tip of the soldering iron to the terminal electrodes.]

### 9.3 Maintenance of heat gun (for your reference)

- △ Power output: 30W
- △ Temperature: 350°C Max
- △ Heat time: More than 5 seconds heating may cause short circuit of parts.

## 10. Solder Volume

Solder shall be used not to exceed as shown below.

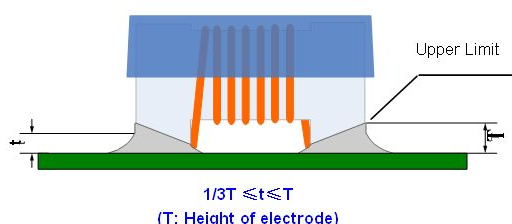



- a. Accordingly increasing the solder volume, the mechanical stress to chip is also increased. Exceeding solder volume may cause the failure of mechanical or electrical performance.
- b. Before soldering, please ensure that the solder should not adhere to the wire part of chip.
- c. Please pay particular attention to whether there is flux remaining on surface of the wire part of chip after subjected to reflow soldering since this may causing short circuit of parts.

## 11. Cleaning

Products shall be cleaned on the following conditions:

- a. Cleaning temperature shall be limited to 60°C Max. (40°C Max. for fluoride and alcohol type cleaner.)
- b. Ultrasonic cleaning shall comply with the following conditions, avoiding the resonance phenomenon at the mounted products and PCB.
  - Power: 20W/l Max.
  - Frequency: 28 KHz to 40 KHz
  - Time: 5 minutes Max
- c. Cleaner
  - i. Alternative cleaner
    - Isopropyl alcohol (IPA)
    - HCFC-225
  - ii. Aqueous agent
    - Surface Active Agent Type (Clean through-750H)
    - Hydrocarbon Type (Techno Cleaner-335)
    - Higher Alcohol Type (Pine Alpha ST-100S)
    - Alkali saponifier Type (※ Aqua Cleaner 240)
    - ※ Alkali saponification shall be diluted to 20% volume with de-ionized water.
    - ※ Please contact our technical service department before using other cleaner.
- d. There shall be no residual flux and residual cleaner after cleaning. In the case of using aqueous agent, product shall be dried completely after rinse with de-ionized water in order to remove the cleaner.
- e. Some products may become slightly whitened. However, product performance or usage is not affected.
- f. Please take care of winding part while cleaning.
- g. After cleaning, parts could be subjected to the next reflow soldering till the solvent remaining on surface of parts being volatilized.

## 12. Others

- a. We will not inform you of the improvement on specification of parts in advance.
- b. We will not inform you of the change on specification of parts during design in advance.
- c. Please contact us for the date to realize mass production of parts being designed.

Appendix : Appearance standard

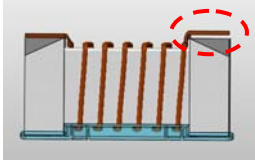
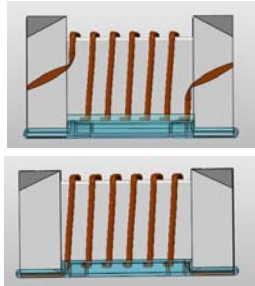
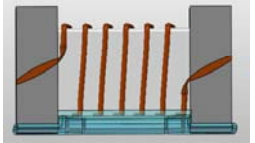
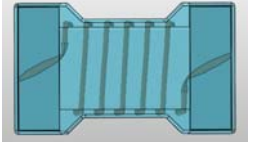
File No:		Applied to Wire Wound Ceramic Inductor Series	
Effective date:			
No.	Defect Item Item	Graphic Schematic Drawing	Rejection identification Criteria
1	Wire off/ Welding Spot Off		The solder joint Welding Spot of wire break away from electrodes, or over the electrodes.
2	Solder misplace		Solder joints are not at electrode side but at the coating side or flank.
3	Coating misplace		Coating at flank
			Coating at electrodes side