

## Features

- 65Watts peak pulse power ( $t_p = 8/20\mu s$ )
- Tiny DFN0603 package
- Bidirectional configurations
- Solid-state silicon-avalanche technology
- Low clamping voltage
- Low leakage current
- Low capacitance ( $C_j = 6pF$  typ.)

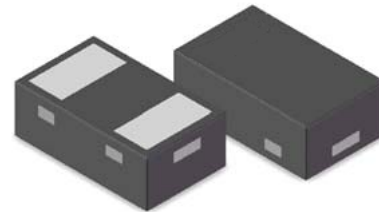

**DFN0603**

## IEC COMPATIBILITY (EN61000-4)

- IEC 61000-4-2  $\pm 25kV$  contact  $\pm 25kV$  air
- IEC 61000-4-4 (EFT) 40A (5/50ns)
- IEC 61000-4-5 (Lightning) 6A (8/20 $\mu s$ )

## Mechanical Characteristics

- DFN0603 package
- Molding compound flammability rating:  
UL 94V-0
- Packaging: Tape and Reel
- RoHS/WEEE Compliant

## Applications

- Cell Phone Handsets and Accessories
- Microprocessor based equipment
- Personal Digital Assistants (PDA's)
- Notebooks, Desktops, and Servers
- Portable Instrumentation

## Schematic & PIN Configuration

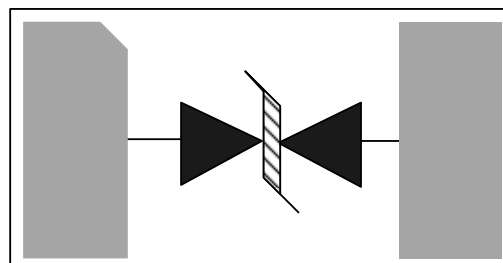

**DFN0603**

### Absolute Maximum Rating

Rating	Symbol	Value	Units
Peak Pulse Power ( $t_p = 8/20\mu s$ )	$P_{PP}$	65	Watts
Peak Pulse Current ( $t_p = 8/20\mu s$ ) (note1)	$I_{pp}$	6	A
ESD per IEC 61000-4-2 (Air) ESD per IEC 61000-4-2 (Contact)	$V_{ESD}$	25 25	kV
Lead Soldering Temperature	$T_L$	260(10seconds)	°C
Junction Temperature	$T_J$	-55 to + 125	°C
Storage Temperature	$T_{stg}$	-55 to + 125	°C

### Electrical Characteristics

Parameter	Symbol	Conditions	Min	Typical	Max	Units
Reverse Stand-Off Voltage	$V_{RWM}$				5.0	V
Reverse Breakdown Voltage	$V_{BR}$	$I_T = 1mA$	5.5	6.5	8.5	V
Reverse Leakage Current	$I_R$	$V_{RWM} = 5V, T = 25^\circ C$		0.1	0.5	$\mu A$
Clamping Voltage	$V_C$	$I_{PP} = 6A, t_p = 8/20\mu s$			11	V
Junction Capacitance	$C_j$	$V_R = 0V, f = 1MHz$		6	8	pF

### Electrical Parameters (TA = 25°C unless otherwise noted)

Symbol	Parameter
$I_{PP}$	Maximum Reverse Peak Pulse Current
$V_C$	Clamping Voltage @ $I_{PP}$
$V_{RWM}$	Working Peak Reverse Voltage
$I_R$	Maximum Reverse Leakage Current @ $V_{RWM}$
$V_{BR}$	Breakdown Voltage @ $I_T$
$I_T$	Test Current

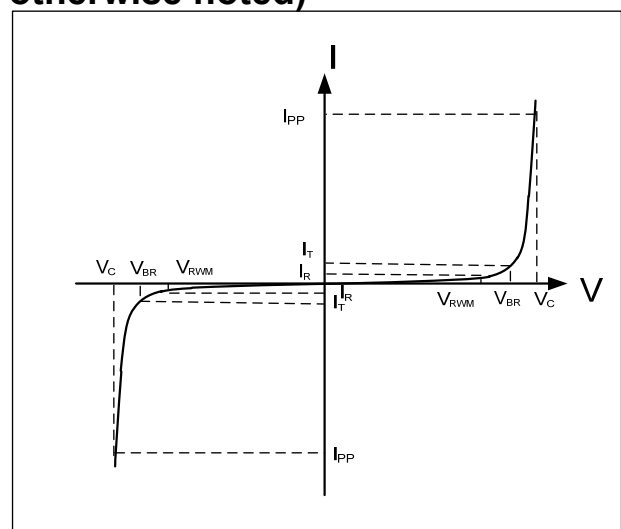

Note: 8/20 $\mu s$  pulse waveform.

**Figure 1: Peak Pulse Power vs. Pulse Time**

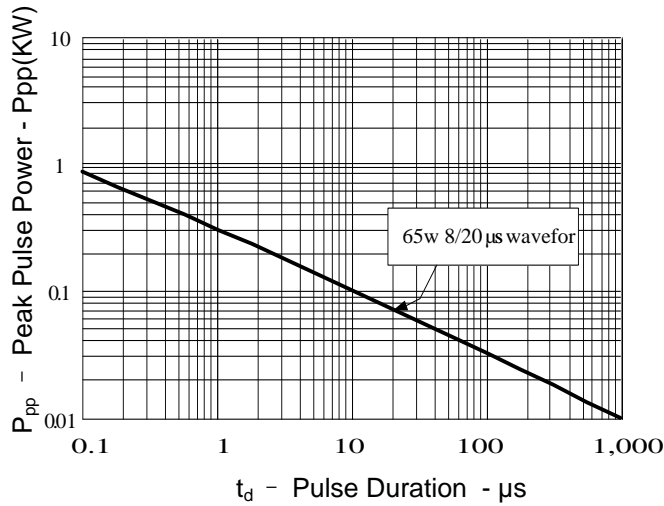

**Figure 2: Power Derating Curve**

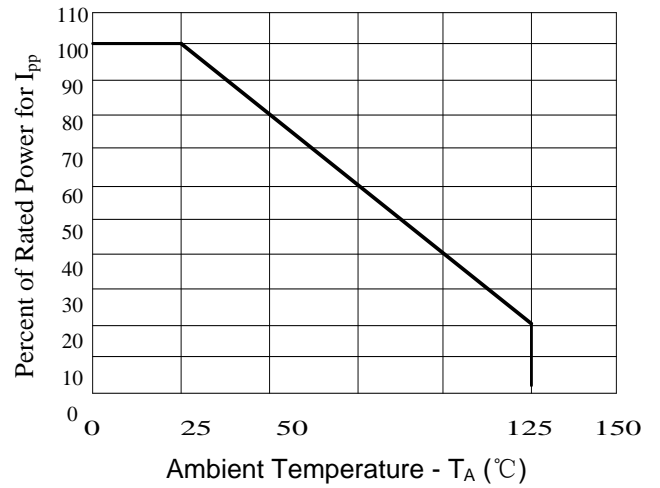

**Figure3: Pulse Waveform**

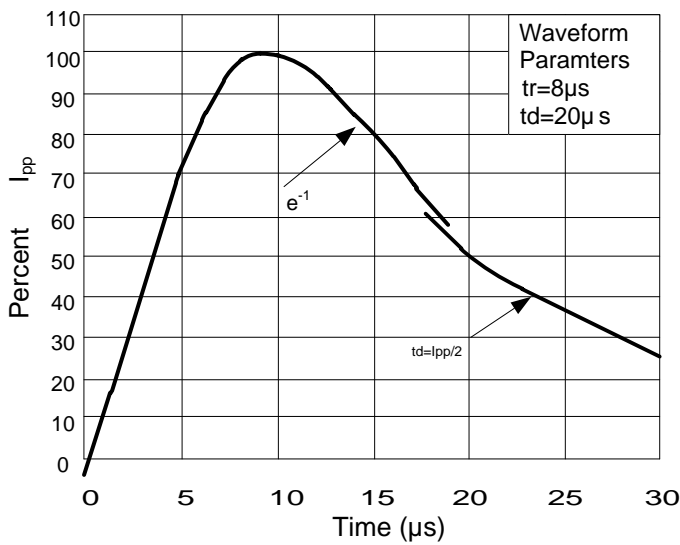

**Figure 4: Clamping Voltage vs. I\_pp**

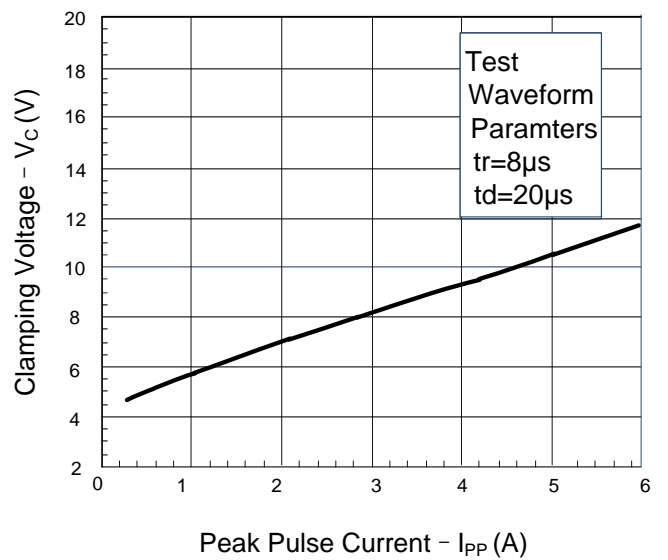

## Outline Drawing – DFN0603

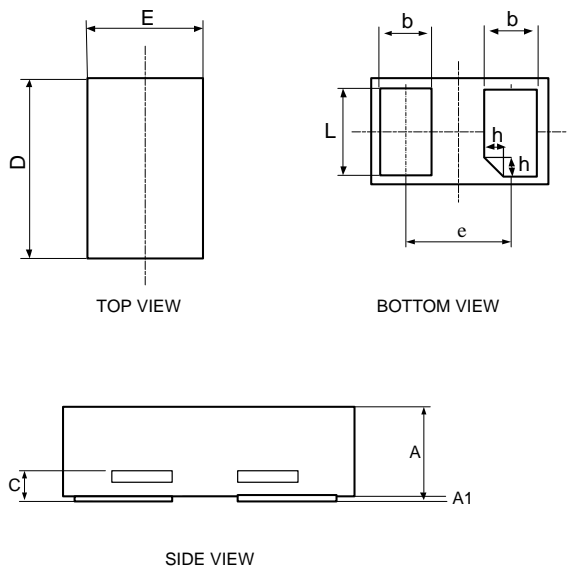

Symbol	Dimensions in millimeters		
	Min	Nom	Max
A	0.28	0.30	0.32
A1	0.00	0.02	0.05
C	0.05	0.10	0.15
D	0.55	0.60	0.65
E	0.25	0.30	0.35
e	0.34	0.35	0.37
b	0.14	0.19	0.24
L	0.20	0.25	0.30
h	0	0.05	0.10

## Marking

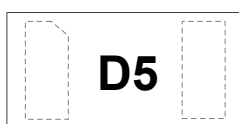

## Ordering information

Order code	Package	Base qty	Delivery mode
PTN062L6M5B6	DFN0603	10k	Tape and reel