

**DO-204AC(DO-15)  
Axial Leaded**

## Features

- Glass passivated chip
- 600 W peak pulse power capability with a 10/1000 us waveform, repetitive rate (duty cycle):0.01 %
- Excellent clamping capability
- Low reverse leakage
- Very fast response time
- Lead and body according with RoHS standard

## Mechanical Characteristics

- Case: DO-15 Molded plastic
- Lead: Solderable per MIL-STD-750, method 2026
- Epoxy: UL 94V-0 rate flame retardant
- Polarity: Color band denotes cathode end except Bipolar
- Mounting position: Any

## Applications

- I/O Interfaces
- Power lines
- Telecommunication
- Consumer electronic
- Industrial Electronics

## Maximum Ratings and Electrical Characteristics

Rating	Symbol	Value	Units
Peak power dissipation with a 10/1000 us waveform <sup>(1)</sup>	$P_{PP}$	600	W
Peak pulse current with a 10/1000 us waveform <sup>(1)</sup>	$I_{PP}$	See Next Table	A
Power dissipation on infinite heatsink at $T_L = 75\text{ }^\circ\text{C}$	$P_D$	5.0	W
Peak forward surge current, 8.3 ms single half sinewave unidirectional only <sup>(2)</sup>	$I_{FSM}$	60	A
Maximum instantaneous forward voltage at 25 A for unidirectional only <sup>(3)</sup>	$V_F$	3.5/6.5	V
Operating junction and storage temperature range	$T_J, T_{STG}$	-55 to + 150	$^\circ\text{C}$

1) Non-repetitive current pulse per Fig.5 and derated above  $T_A = 25\text{ }^\circ\text{C}$  per Fig.1 ;

2) Measured on 8.3 ms single half sine-wave or equivalent square wave, duty cycle = 4 pulses per minute maximum ;

3)  $V_F < 3.5\text{V}$  for devices of  $V_{BR} < 200\text{V}$  and  $V_F < 6.5\text{V}$  for devices of  $V_{BR} > 201\text{V}$ .

## Electrical Characteristics

Part Number		Reverse Stand off Voltage $V_{RWM}$ (V)	Breakdown Voltage $V_{BR}(V)@I_T$		Test Current $I_T$ (mA)	Maximum Clamping Voltage $V_C@I_{PP}$ (V)	Maximum PeakPulse Current $I_{PP}$ (A)	Maximum Reverse Leakage $I_R@V_{RWM}$ ( $\mu$ A)
UNI-POLAR	BI-POLAR		MIN	MAX				
P6KE6.8A	P6KE6.8CA	5.80	6.45	7.14	10	10.5	58.1	1000
P6KE7.5A	P6KE7.5CA	6.40	7.13	7.88	10	11.3	54.0	500
P6KE8.2A	P6KE8.2CA	7.00	7.79	8.61	10	12.1	50.4	200
P6KE9.1A	P6KE9.1CA	7.80	8.65	9.55	1	13.4	45.5	50
P6KE10A	P6KE10CA	8.60	9.50	10.50	1	14.5	42.1	10
P6KE11A	P6KE11CA	9.40	10.50	11.60	1	15.6	39.1	5
P6KE12A	P6KE12CA	10.20	11.40	12.60	1	16.7	36.5	5
P6KE13A	P6KE13CA	11.10	12.40	13.70	1	18.2	33.5	1
P6KE15A	P6KE15CA	12.80	14.30	15.80	1	21.2	28.8	1
P6KE16A	P6KE16CA	13.60	15.20	16.80	1	22.5	27.1	1
P6KE18A	P6KE18CA	15.30	17.10	18.90	1	25.5	24.2	1
P6KE20A	P6KE20CA	17.10	19.00	21.00	1	27.7	22.0	1
P6KE22A	P6KE22CA	18.80	20.90	23.10	1	30.6	19.9	1
P6KE24A	P6KE24CA	20.50	22.80	25.20	1	33.2	18.4	1
P6KE27A	P6KE27CA	23.10	25.70	28.40	1	37.5	16.3	1
P6KE30A	P6KE30CA	25.60	28.50	31.50	1	41.4	14.7	1
P6KE33A	P6KE33CA	28.20	31.40	34.70	1	45.7	13.3	1
P6KE36A	P6KE36CA	30.80	34.20	37.80	1	49.9	12.2	1
P6KE39A	P6KE39CA	33.30	37.10	41.00	1	53.9	11.3	1
P6KE43A	P6KE43CA	36.80	40.90	45.20	1	59.3	10.3	1
P6KE47A	P6KE47CA	40.20	44.70	49.40	1	64.8	9.4	1
P6KE51A	P6KE51CA	43.60	48.50	53.60	1	70.1	8.7	1
P6KE56A	P6KE56CA	47.80	53.20	58.80	1	77.0	7.9	1
P6KE62A	P6KE62CA	53.00	58.90	65.10	1	85.0	7.2	1
P6KE68A	P6KE68CA	58.10	64.60	71.40	1	92.0	6.6	1
P6KE75A	P6KE75CA	64.10	71.30	78.80	1	103.0	5.9	1
P6KE82A	P6KE82CA	70.10	77.90	86.10	1	113.0	5.4	1
P6KE91A	P6KE91CA	77.80	86.50	95.50	1	125.0	4.9	1
P6KE100A	P6KE100CA	85.50	95.00	105.00	1	137.0	4.5	1
P6KE110A	P6KE110CA	94.00	105.00	116.00	1	152.0	4.0	1
P6KE120A	P6KE120CA	102.00	114.00	126.00	1	165.0	3.7	1
P6KE130A	P6KE130CA	111.00	124.00	137.00	1	179.0	3.4	1

**Electrical Characteristics** (continued)

Part Number		Reverse Stand off Voltage $V_{RWM}$ (V)	Breakdown Voltage $V_{BR}(V)@I_T$		Test Current $I_T$ (mA)	Maximum Clamping Voltage $V_C@I_{PP}$ (V)	Maximum Peak Pulse Current $I_{PP}$ (A)	Maximum Reverse Leakage $I_R@V_{RWM}$ ( $\mu$ A)
UNI-POLAR	BI-POLAR		MIN	MAX				
P6KE150A	P6KE150CA	128.00	143.00	158.00	1	207.0	2.9	1
P6KE160A	P6KE160CA	136.00	152.00	168.00	1	219.0	2.8	1
P6KE170A	P6KE170CA	145.00	162.00	179.00	1	234.0	2.6	1
P6KE180A	P6KE180CA	154.00	171.00	189.00	1	246.0	2.5	1
P6KE200A	P6KE200CA	171.00	190.00	210.00	1	274.0	2.2	1
P6KE220A	P6KE220CA	185.00	209.00	231.00	1	328.0	1.9	1
P6KE250A	P6KE250CA	214.00	237.00	263.00	1	344.0	1.8	1
P6KE300A	P6KE300CA	256.00	285.00	315.00	1	414.0	1.5	1
P6KE350A	P6KE350CA	300.00	332.00	368.00	1	482.0	1.3	1
P6KE400A	P6KE400CA	342.00	380.00	420.00	1	548.0	1.1	1
P6KE440A	P6KE440CA	376.00	418.00	462.00	1	602.0	1.0	1
P6KE480A	P6KE480CA	408.00	456.00	504.00	1	658.0	0.9	1
P6KE510A	P6KE510CA	434.00	485.00	535.00	1	698.0	0.9	1
P6KE520A	P6KE520CA	442.00	494.00	546.00	1	698.0	0.9	1
P6KE530A	P6KE530CA	450.00	503.00	556.00	1	725.0	0.8	1
P6KE540A	P6KE540CA	459.00	513.00	567.00	1	740.0	0.8	1
P6KE550A	P6KE550CA	467.00	522.50	577.50	1	760.0	0.8	1
P6KE600A	P6KE600CA	509.00	570.00	630.00	1	780.0	0.8	1

**Ratings and Characteristics Curves (TA=25°C unless otherwise noted)**

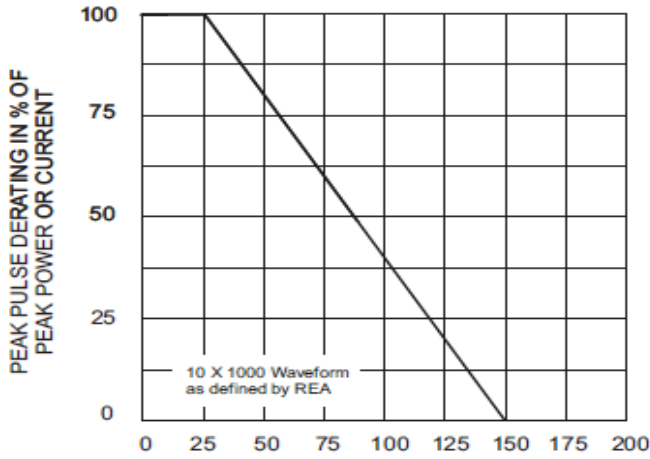

Fig. 1 - Pulse Derating Curve

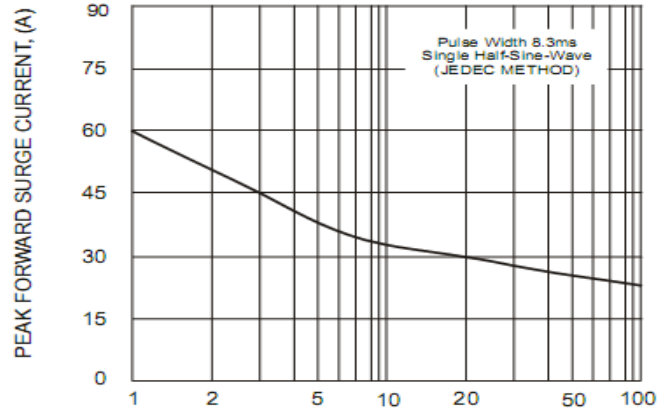

Fig. 2 - Maximum Non-Repetitive Surge Current

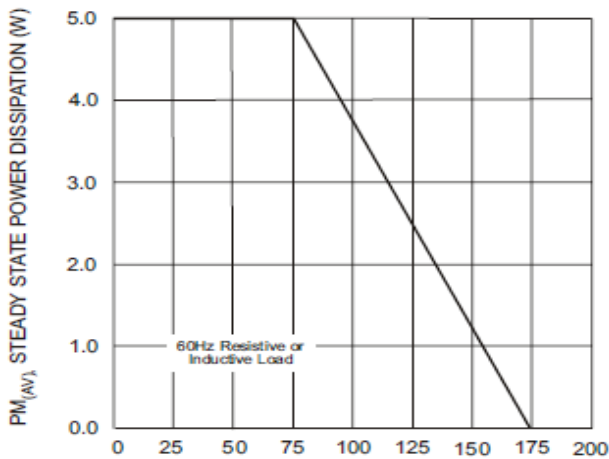

Fig. 3 - Steady State Power Derating Curve

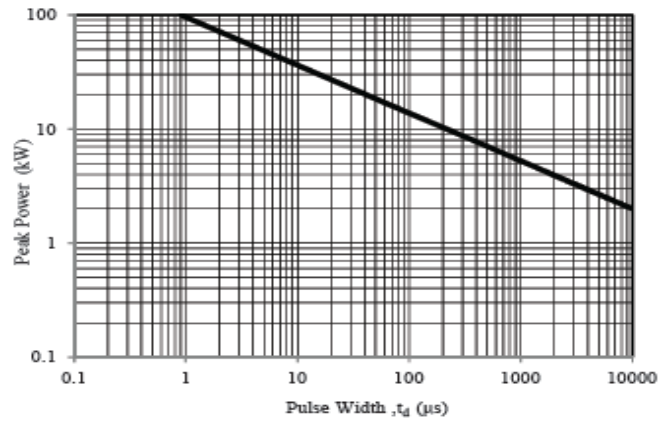

Fig. 4 - Peak Pulse Power Rating Curve

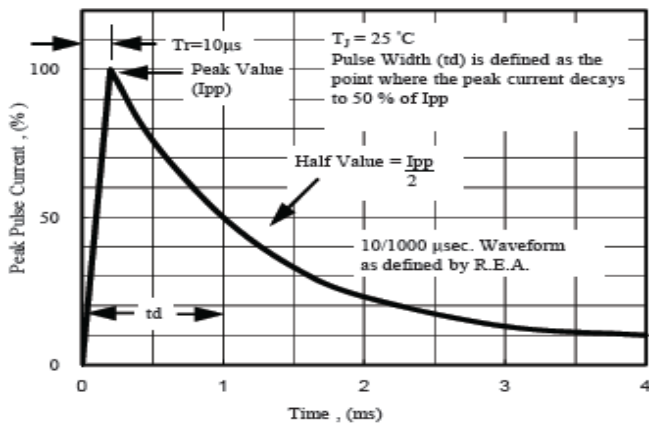

Fig. 5 - Pulse Waveform

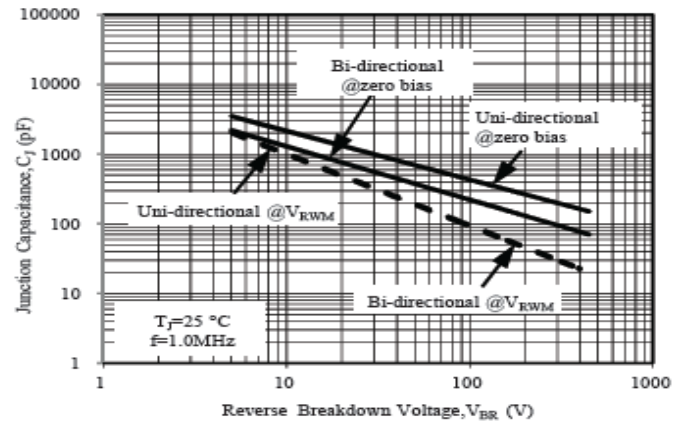
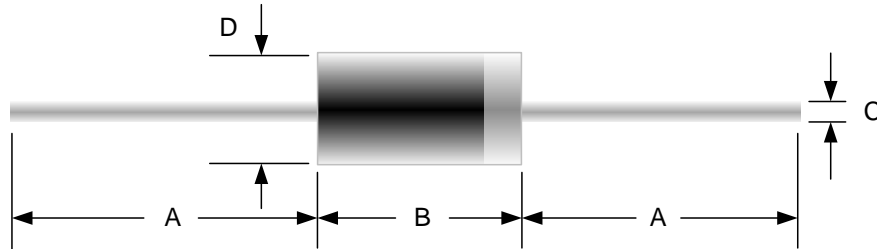

Fig. 6 - Typical Junction Capacitance

### PACKAGE OUTLINE DIMENSION



**DO-204AC(DO-15)**

Ref. (mm)	Inches		Millimeters	
	Min.	Max.	Min.	Max.
A	1.000	-	25.40	-
B	0.230	0.300	5.80	7.60
C	0.028	0.034	0.70	0.90
D	0.104	0.140	2.60	3.60

### Part Numbering System

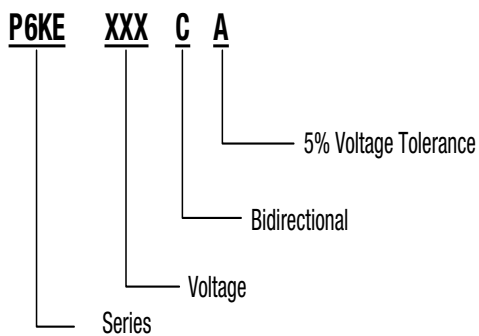

### Part Marking System

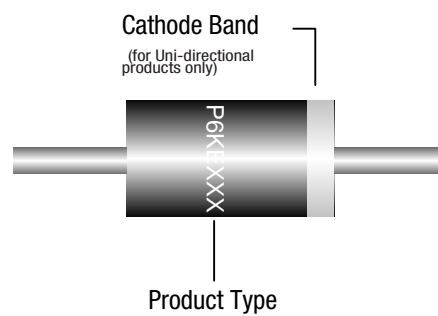

### Package Information

**Qty: 4,000 /Tape and reel  
500 /Bulk**