



## Specification for Approval

- DEVICE NUMBER: BL-HB535A-AV-TRB

**SAMPLES  
ATTACHED AREA**

| DATE       | PAGE |     |     |     |     |     |     |  |  |  | CONTENTS         |
|------------|------|-----|-----|-----|-----|-----|-----|--|--|--|------------------|
|            | 1    | 2   | 3   | 4   | 5   | 6   | 7   |  |  |  |                  |
| 2014.07.10 | 1.0  | 1.0 | 1.0 | 1.0 | 1.0 | 1.0 | 1.0 |  |  |  | Initial Released |
| 2018.04.23 | 1.1  | 1.1 | 1.1 | 1.1 | 1.1 | 1.1 | 1.1 |  |  |  | Updated version  |
|            |      |     |     |     |     |     |     |  |  |  |                  |
|            |      |     |     |     |     |     |     |  |  |  |                  |
|            |      |     |     |     |     |     |     |  |  |  |                  |
|            |      |     |     |     |     |     |     |  |  |  |                  |
|            |      |     |     |     |     |     |     |  |  |  |                  |
|            |      |     |     |     |     |     |     |  |  |  |                  |

**FOR CUSTOMER'S APPROVAL STAMP OR SIGNATURE**

| APPROVED | PURCHASE | MANUFACTURE | QUALITY | ENGINEERING |
|----------|----------|-------------|---------|-------------|
|          |          |             |         |             |

佰鴻工業股份有限公司  
 BRIGHT LED ELECTRONICS CORP.  
 新北市板橋區和平路 19 號 3 樓  
 3F., No.19, He Ping Road,  
 Ban Qiao Dist., New Taipei City,  
 Taiwan  
 Tel: +886-2-29591090

| ISSUED | APPROVED | PREPARED |
|--------|----------|----------|
|        |          |          |

### ● Features:

1. Emitted Color : Super Blue
2. Lens Appearance : Water Clear.
3. Mono-color type.
4. 2.0x1.25x1.0mm(0805) standard package.
5. Suitable for all SMT assembly methods.
6. Compatible with infrared and vapor phase reflow solder process.
7. Compatible with automatic placement equipment.
8. This product doesn't contain restriction Substance, comply ROHS standard.

### ● Package Dimensions:

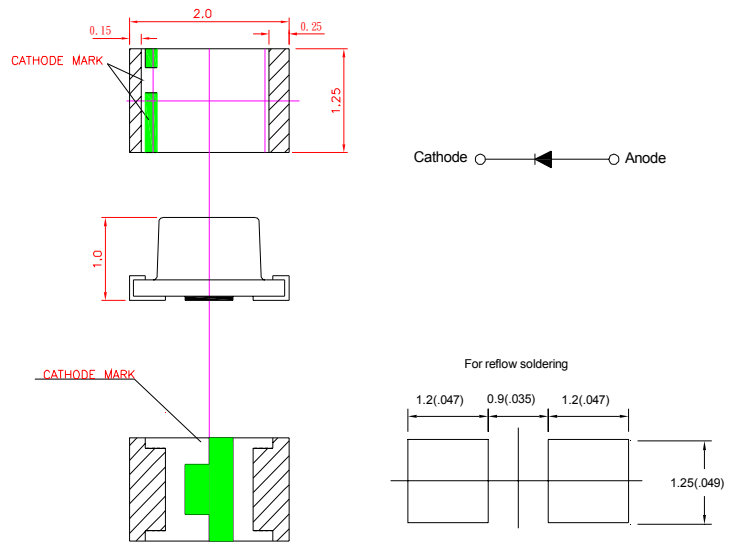

### NOTES:

1. All dimensions are in millimeters .
2. Tolerance is  $\pm 0.10$ mm unless otherwise specified.
3. Specifications are subject to change without notice.

### ● Applications:

1. Backlighting : LCDs, Key pads advertising.
2. Status indicators : Consumer & industrial electronics.
3. General use.

### ● Absolute Maximum Ratings(Ta=25°C)

| Parameter                | Symbol          | Rating     | Unit |
|--------------------------|-----------------|------------|------|
| Power Dissipation        | Pd              | 70         | mW   |
| Forward Current          | I <sub>F</sub>  | 20         | mA   |
| Peak Forward Current * 1 | I <sub>FP</sub> | 100        | mA   |
| Reverse Voltage          | V <sub>R</sub>  | 5          | V    |
| Operating Temperature    | Topr            | -40°C~85°C | -    |
| Storage Temperature      | Tstg            | -40°C~85°C | -    |
| Soldering Temperature    | Tsol            | See Page 6 | -    |

\* 1 Condition for I<sub>FP</sub> is pulse of 1/10 duty and 0.1msec width.

### ● Electrical and optical characteristics(Ta=25°C)

| Parameter                | Symbol            | Condition           | Min. | Typ. | Max. | Unit |
|--------------------------|-------------------|---------------------|------|------|------|------|
| Forward Voltage          | V <sub>f</sub>    | I <sub>F</sub> =2mA | -    | 2.6  | 3.0  | V    |
| Luminous Intensity       | I <sub>v</sub>    | I <sub>F</sub> =2mA | 5.5  | 15   | -    | mcd  |
| Reverse Current          | I <sub>R</sub>    | V <sub>R</sub> =5V  | -    | -    | 1    | μA   |
| Peak Wave Length         | λ <sub>p</sub>    | I <sub>F</sub> =2mA | -    | 470  | -    | nm   |
| Dominant Wave Length     | λ <sub>d</sub>    | I <sub>F</sub> =2mA | 470  |      | 480  | nm   |
| Spectral Line Half-width | Δλ                | I <sub>F</sub> =2mA | -    | 30   | -    | nm   |
| Viewing Angle            | 2θ <sub>1/2</sub> | I <sub>F</sub> =2mA | -    | 120  | -    | deg  |

### ● Typical Electro-Optical Characteristics Curves

Fig.1 Relative intensity vs. wavelength

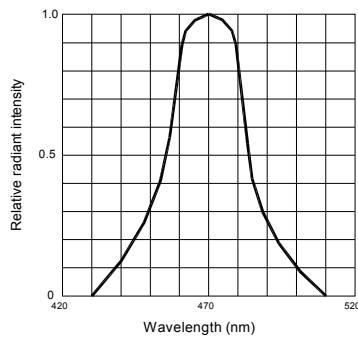

Fig.2 Forward current derating curve vs. ambient temperature

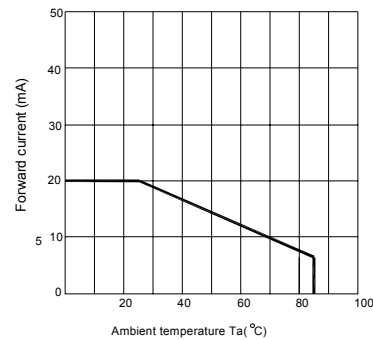

Fig.3 Forward current vs. forward voltage

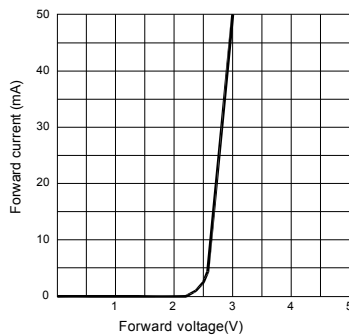

Fig.4 Relative luminous intensity vs. ambient temperature

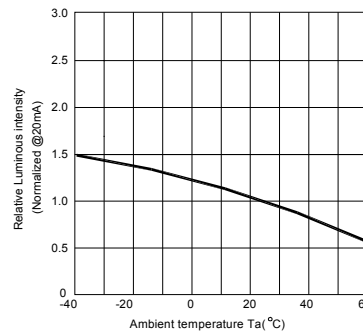

Fig.5 Relative luminous intensity vs. forward current

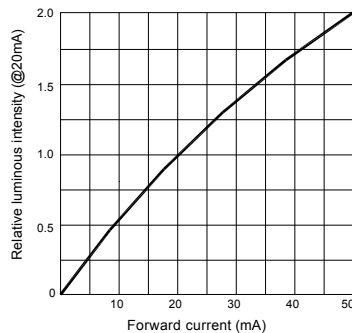
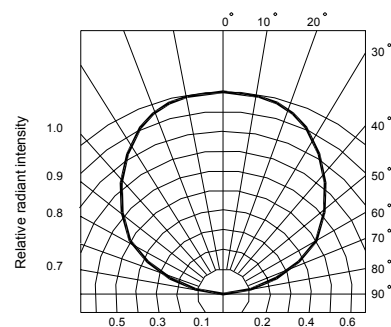
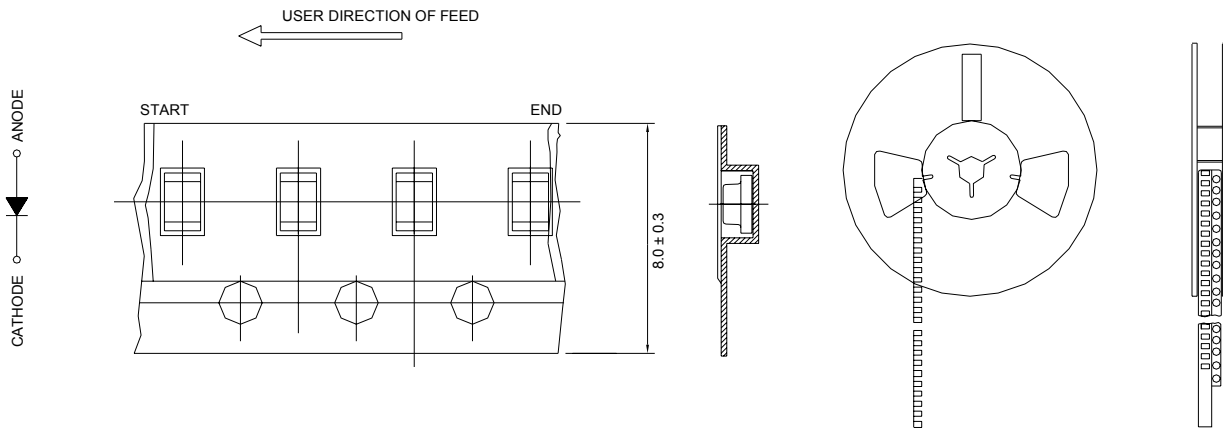

Fig.6 Radiation diagram



● Tapping and packaging specifications(Units: mm)

Quantity:3000pcs



● Package Method:(unit:mm) Vacuum

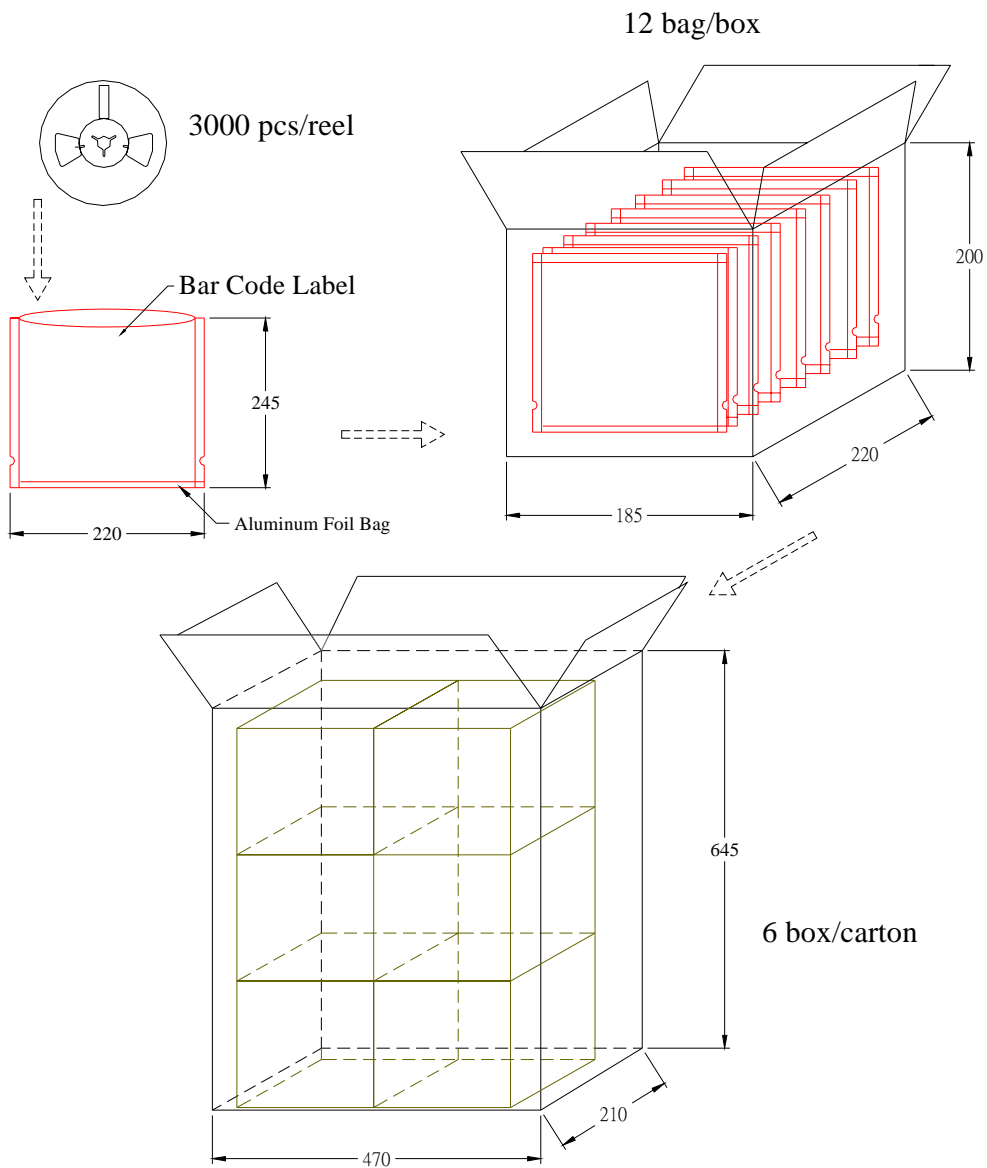

● **Bin Limits**

Intensity Bin Limits (At 2mA)

| BIN CODE | Min. (mcd) | Max. (mcd) |
|----------|------------|------------|
| H        | 5.5        | 8.2        |
| J        | 8.2        | 12.3       |
| K        | 12.3       | 18.5       |
| L        | 18.5       | 28         |
| M        | 28         | 42         |

Tolerance for each Bin limit is  $\pm 15\%$ .

Color Bin Limits (At 2mA)

| BIN CODE | Min. (nm) | Max. (nm) |
|----------|-----------|-----------|
| 5        | 470       | 475       |
| 6        | 475       | 480       |

Tolerance for each Bin limit is  $\pm 1\text{ nm}$ .

$V_F$  Bin Limits (At 2mA)

| BIN CODE | Min.(v) | Max.(v) |
|----------|---------|---------|
| D        | 2.2     | 2.4     |
| E        | 2.4     | 2.6     |
| F        | 2.6     | 2.8     |
| G        | 2.8     | 3.0     |

Tolerance for each Bin limit is  $\pm 0.05\text{V}$ .

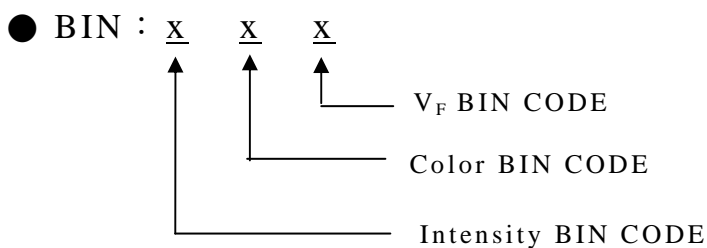



## ● Reliability Test

| Classification     | Test Item                              | Reference Standard   | Test Conditions   | Result |
|--------------------|--|--|---|--------|
| Endurance Test     | Operation Life                         | MIL-STD-750D:1026<br>MIL-STD-883D:1005<br>JIS-C-7021 :B-1                      | Ta: Under room temperature<br>Test time:1,000hrs<br>IF=Product Recommended IF | 0/32   |
|                    | High Temperature High Humidity Storage | MIL-STD-202F:103B<br>JIS-C-7021 :B-11  | Ta:85±5°C<br>RH:90%-95%<br>Test time:240hrs                                   | 0/32   |
|                    | High Temperature Storage               | MIL-STD-883:1008<br>JIS-C-7021 :B-10   | Ta:100±5°C<br>Test time:1,000hrs  | 0/32   |
|                    | Low Temperature Storage                | JIS-C-7021 :B-11   | Ta: -40±5°C<br>Test time=1,000hrs   | 0/32   |
| Environmental Test | Temperature Cycling                    | MIL-STD-202F:107D<br>MIL-STD-750D:1051<br>MIL-STD-883D:1010<br>JIS-C-7021 :A-2 | Ta:-35±5°C~25±5°C~85±5°C~25±5°C<br>30min 5min 30min 5min                      | 0/32   |
|                    | Thermal Shock                          | MIL-STD-202F:107D(1980)<br>MIL-STD-750D:1051(95)<br>MIL-STD-883D:1011(1991)    | Ta:-40±5°C ~+85±5°C<br>10min 10 min<br>Time: 20min/cycle 10cycle              | 0/32   |
|                    | Wetting balance                        | MIL-STD-883:2003<br>MIL-STD-202F:208D<br>MIL-STD-883D:2003                     | Ta:230±5°C<br>Time:5±0.5s   | 0/32   |
|                    | Solder Resistance                      | MIL-STD-202F:210A<br>MIL-STD-883D:1011<br>JIS-C-7021 :A-1                      | Ta:260±10°C<br>Time:10±1s   | 0/32   |

## ● Judgment criteria of failure for the reliability

| Measuring items    | Symbol                 | Measuring conditions | Judgement criteria for failure |
|--------------------|------------------------|----------------------|--------------------------------|
| Forward voltage    | V <sub>F</sub> ( V )   | I <sub>F</sub> =2mA  | Initial Level*1.1              |
| Reverse current    | I <sub>R</sub> (uA)    | V <sub>R</sub> =5V   | Over U*2                       |
| Luminous intensity | I <sub>v</sub> ( mcd ) | I <sub>F</sub> =2mA  | Initial Level*0.7              |

Note: 1.U means the upper limit of specified characteristics.

2.Measurment shall be taken between 2 hours and after the test pieces have been returned to normal ambient conditions after completion of each test.

## ● IR-Reflow Soldering

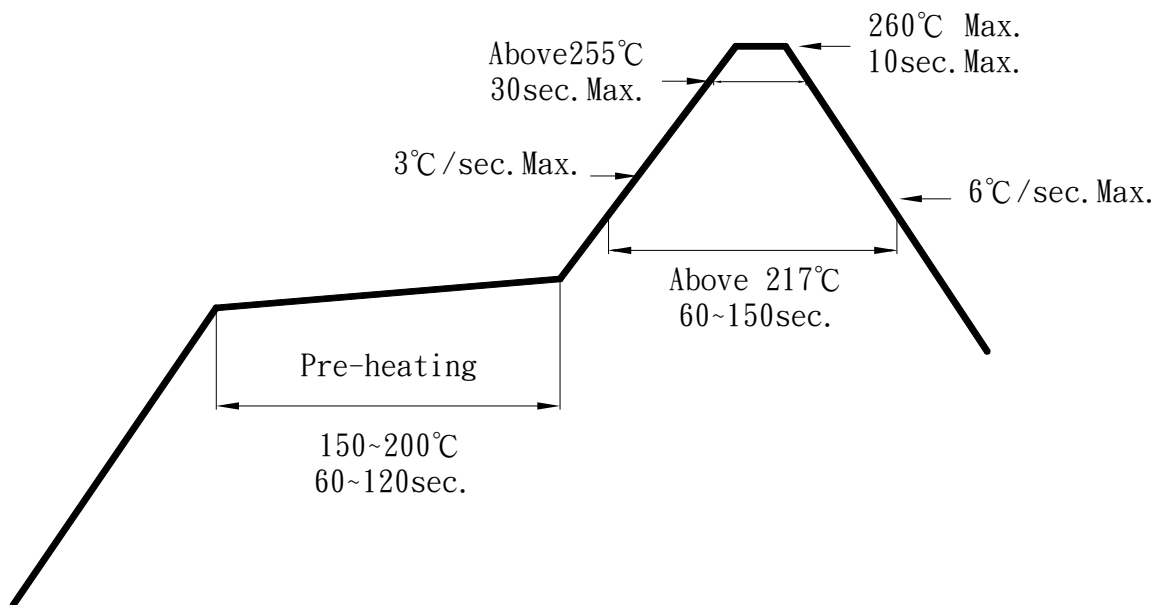

1. Avoid any external stress applied to the resin while the LEDs are at high temperature, especially during soldering .
2. Avoid rapid cooling or any excess vibration during temperature ramp-down process
3. Although the soldering condition is recommended above, soldering at the lowest possible temperature is feasible for the LEDs

## ● IRON Soldering

**350°C Within 3 sec.,One time only.**



### ● Notes for designing:

Care must be taken to provide the current limiting resistor in the circuit so as to drive the BRIGHT LEDs within the rated figures. Also, caution should be taken not to overload BRIGHT LEDs with instantaneous voltage at the turning ON and OFF of the circuit.

When using the pulse drive care must be taken to keep the average current within the rated figures. Also, the circuit should be designed so as to be subjected to reverse voltage when turning off the BRIGHT LEDs.

### ● Storage:

In order to avoid the absorption of moisture, it is recommended to solder BRIGHT LEDs as soon as possible after unpacking the sealed envelope.

If the envelope is still packed, to store it in the environment as following:

- (1) Temperature : 5°C -30°C (41°F) Humidity : RH 60% Max.
- (2) After this bag is opened, devices that will be applied to infrared reflow, vapor-phase reflow, or equivalent soldering process must be:
  - a. Completed within 168 hours.
  - b. Stored at less than 30% RH.
- (3) Devices require baking before mounting, if:
  - (2) a or (2) b is not met.
- (4) If baking is required, devices must be baked under below conditions:  
48 hours at 60°C±3°C.

### ● Package and Label of Products:

- (1) Package: Products are packed in one bag of 3000 pcs (one taping reel) and a label is attached on each bag.
- (2) Label:

