

### Features

- Ultra low capacitance: 0.5pF typical
- Ultra low leakage: nA level
- Low operating voltage: 3.3V
- Low clamping voltage
- 2-pin leadless package
- Complies with following standards:
  - IEC 61000-4-2 (ESD) immunity test
    - Air discharge:  $\pm 20\text{kV}$
    - Contact discharge:  $\pm 15\text{kV}$
  - IEC61000-4-5 (Lightning) 5A (8/20 $\mu\text{s}$ )
- RoHS Compliant
- Lead Finish: NiPdAu

### Applications

- Smart phones
- Display Ports
- MDDI Ports
- USB Ports
- Digital Video Interface (DVI)
- PCI Express and Serial SATA Ports

### Dimensions DFN0603



### Pin Configuration

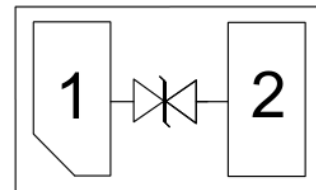

### Mechanical Characteristics

- Package: DFN0603
- Lead Finish: Lead Free
- UL Flammability Classification Rating 94V-0
- Quantity Per Reel: 10,000pcs
- Reel Size: 7 inch
- Device Marking: 1S

### Absolute Maximum Ratings (T<sub>amb</sub>=25°C unless otherwise specified)

Parameter	Symbol	Value	Unit
Peak Pulse Power (8/20 $\mu\text{s}$ )	P <sub>pp</sub>	35	W
ESD per IEC 61000-4-2 (Air)	V <sub>ESD</sub>	$\pm 25$	Kv
ESD per IEC 61000-4-2 (Contact)		$\pm 20$	
Operating Temperature Range	T <sub>J</sub>	-40 to +125	°C
Storage Temperature Range	T <sub>STJ</sub>	-55 to +150	°C

## Electrical Characteristics (TA=25°C unless otherwise specified)

Parameter	Symbol	Test Condition	Min	Typ	Max	Unit
Reverse Working Voltage	$V_{RWM}$				3.3	V
Breakdown Voltage	$V_{BR}$	$I_T = 1\text{mA}$	8.0	12.0	14.0	V
Holding Voltage	$V_h$	$I_T = 100\text{mA}$	2.6		4.0	V
Reverse Leakage Current	$I_R$	$V_{RWM} = 3.3\text{V}$			0.2	$\mu\text{A}$
Clamping Voltage	$V_C$	$I_{PP} = 1\text{A}$ (8 x 20 $\mu\text{s}$ pulse)		5.0		V
Clamping Voltage	$V_C$	$I_{PP} = 5\text{A}$ (8 x 20 $\mu\text{s}$ pulse)		6.0	8.0	V
Junction Capacitance	$C_J$	$V_R = 0\text{V}$ , $f = 1\text{MHz}$		0.5	1.0	pF

## Portion Electronics Parameter

Symbol	Parameter
$I_T$	Test Current
$I_{PP}$	Maximum Reverse Peak Pulse Current
$V_C$	Clamping Voltage @ $I_C$

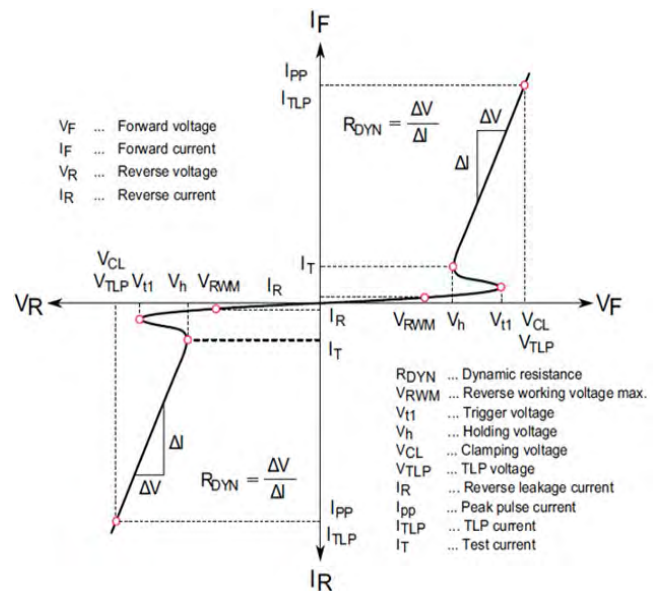

## Typical Performance Characteristics ( $T_A=25^\circ\text{C}$ unless otherwise Specified)

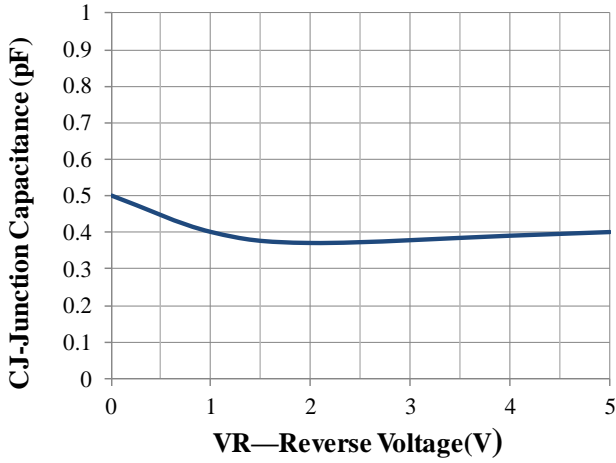

Junction Capacitance vs. Reverse Voltage

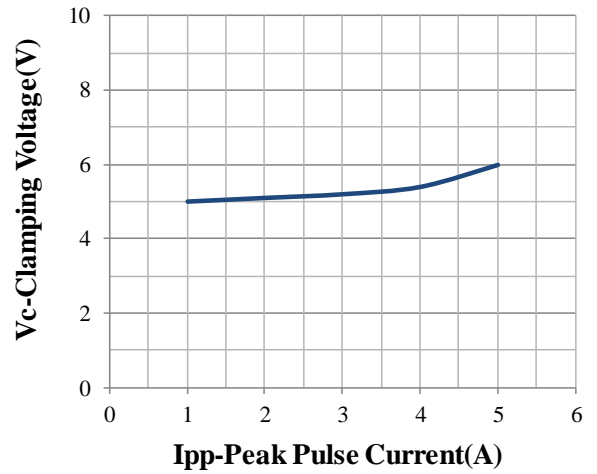

Clamping Voltage vs. Peak Pulse Current

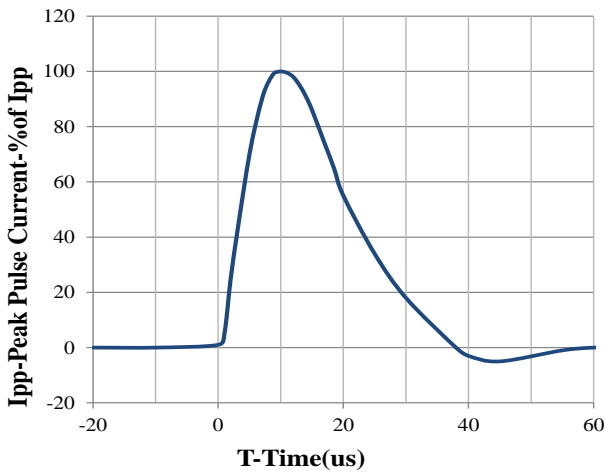

8 X 20us Pulse Waveform

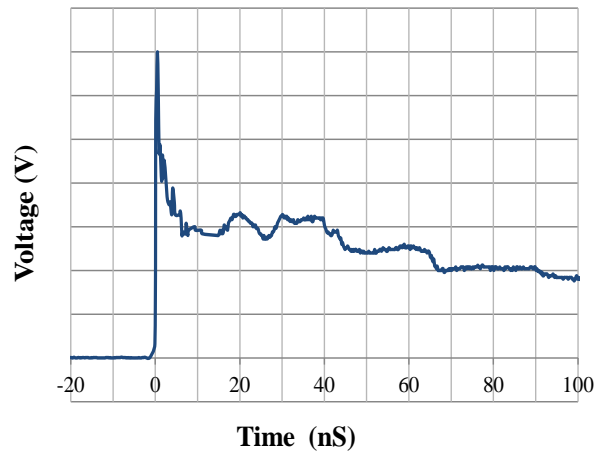

IEC61000-4-2 Pulse Waveform

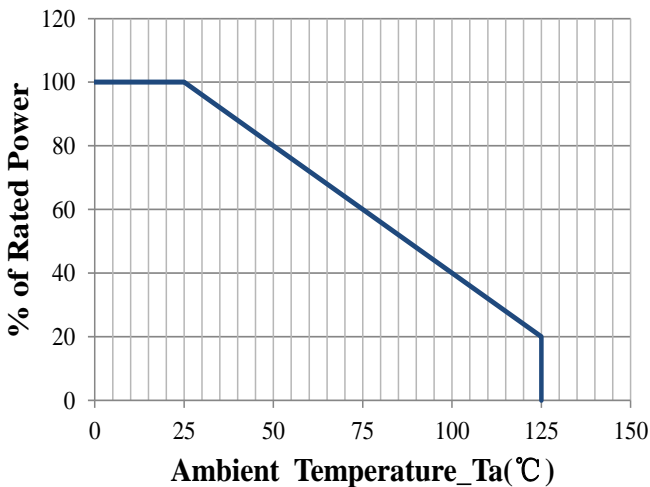

Power Derating Curve

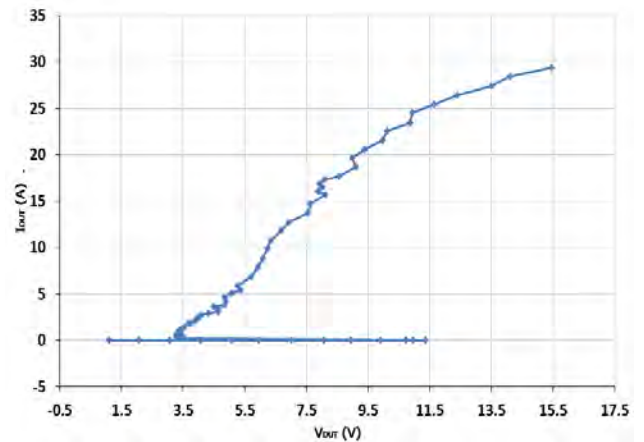

TLP Curve

## DFN0603 PACKAGE OUTLINE & DIMENSIONS

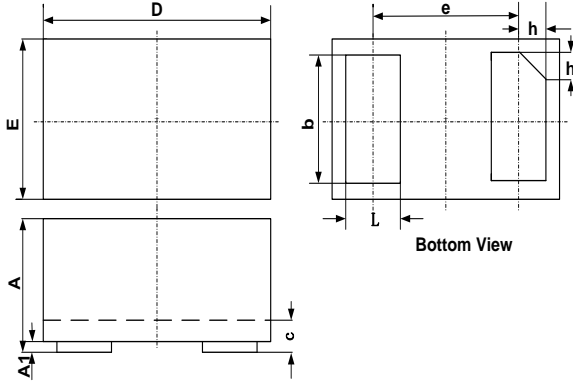

SYM	DIMENSIONS		
	MILLIMETERS		
	MIN	NOM	MAX
A	0.230		0.330
A1	0.000	0.020	0.050
b	0.215	0.245	0.275
c	0.120	0.150	0.180
D	0.550	0.600	0.650
e	0.355 BSC		
E	0.250	0.300	0.350
L	0.160	0.190	0.220
h	0.079 BSC		

## Suggested Land Pattern

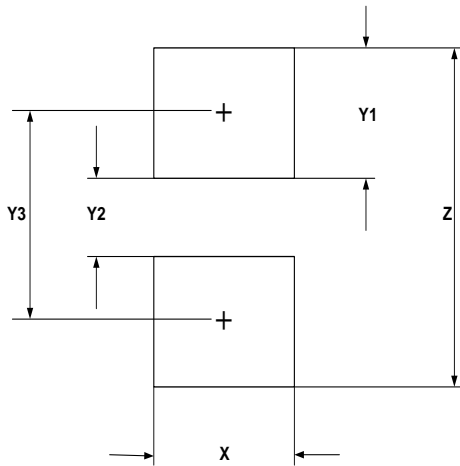

SYM	DIMENSIONS	
	MILLIMETERS	INCHES
X	0.30	0.012
Y1	0.25	0.010
Y2	0.15	0.006
Y3	0.40	0.016
Z	0.65	0.026