

Features

- Low Power Consumption: 2 μ A (Typ)
- Maximum Output Current: 150mA
- Small Dropout Voltage
700mV@100mA (Vout=3.3V)
- High Input Voltage: Up to 80V
- High Accurate:
HE2280(A) \pm 1% Output Voltage
- RoHS Compliant and Lead (Pb) Free
- Good Transient Response
- Integrated Short-Circuit Protection
- Over-Temperature Protection
- Output Current Limit
- Stable with Ceramic Capacitor
- Support Fixed Output Voltage
3.3 and 5.0V
- Available Package
SOT23-3 \ SOT89-3

Application

- Portable, Battery Powered Equipment
- Battery-powered equipment
- Weighting Scales
- Smoke detector and sensor
- Car Audio/Video Equipmen
- Home Automation

Description

The HE2280 series is a high voltage, ultralow-power, low dropout voltage regulator. The device can deliver 150mA output current with a dropout voltage of 700mV and allows an input voltage as high as 80V. The typical quiescent current is only 2 μ A. The device is available in fixed output voltages of 3.3, and 5.0V. The device features integrated short-circuit and thermal shutdown protection. Although designed primarily as fixed voltage regulators, the device can be used with external components to obtain variable voltages.

Selection Table

Part No.	Output Voltage	Package	Marking
HE2280A33PR	3.3V	SOT89-3	****
HE2280A50PR	5.0V	SOT89-3	****
HE2280A33MR	3.3V	SOT23-3	****
HE2280A50MR	5.0V	SOT23-3	****

Application Circuits

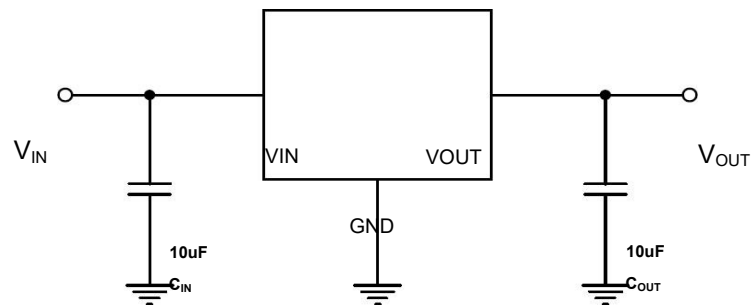

Note: External Component Recommendation: ($V_{IN} > 45V$)

- 1) $C_{IN} = 100\mu F / 100V$ (Electrolysis)
- 2) $V_{IN} / R_1 = 50R$ (0805)

Pin Assignment

SOT89 (Top view)

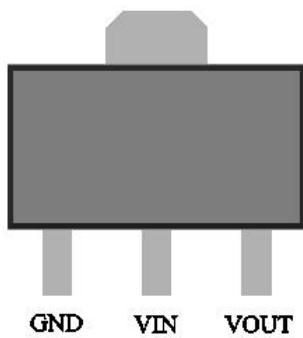

SOT23-3 (Top view)

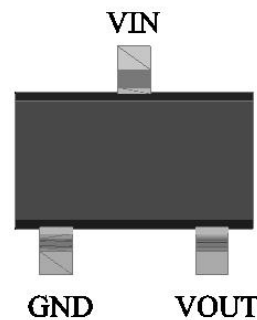

Function Block Diagram

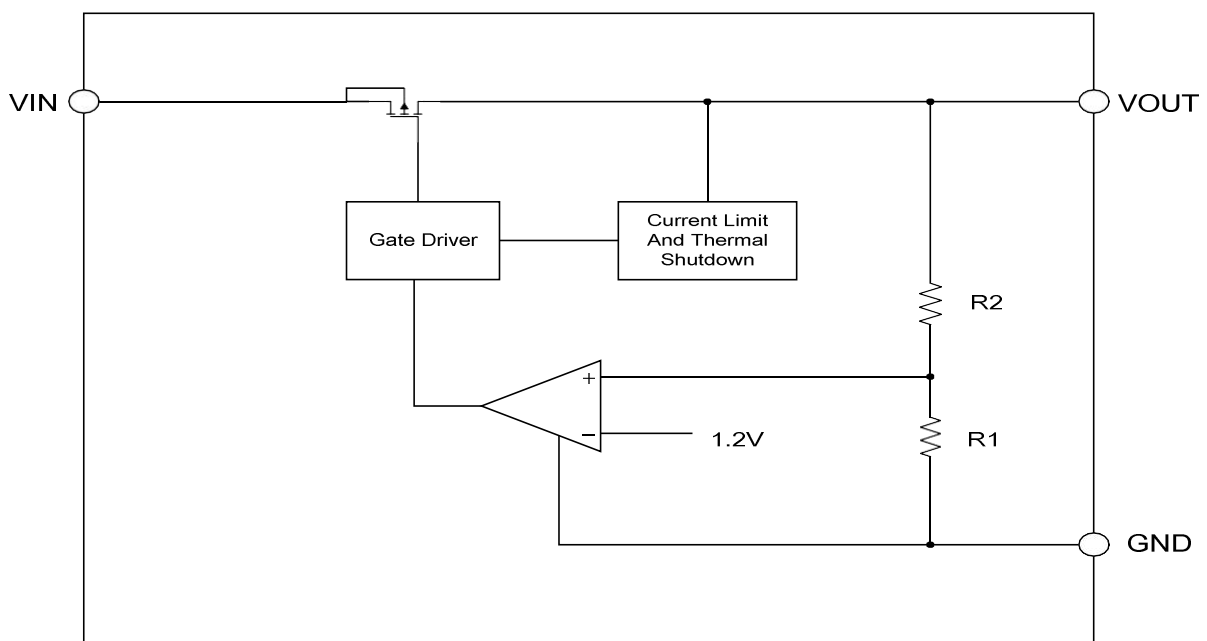

Absolute Maximum Ratings ⁽¹⁾⁽²⁾

Parameter		Symbol	Maximum Rating	Unit
Input Voltage		V _{IN}	V _{SS} -0.3~V _{SS} +80.0	V
		V _{OUT}	V _{SS} -0.3~V _{SS} +6.0	V
Output Current		I _{OUT}	400	mA
Power Dissipation	SOT23-3	P _d	400	mW
	SOT89-3		500	
Thermal Resistance	SOT23-3	R _{θJA} ⁽³⁾	250	°C/W
	SOT89-3		200	°C/W
Operating Temperature		T _{opr}	-40~85	°C
Storage Temperature		T _{stg}	-40~125	°C
Soldering Temperature & Time		T _{solder}	260°C, 10s	

Note (1): Exceeding these ratings may damage the device.

Note (2): The device is not guaranteed to function outside of its operating conditions

Note (3): The package thermal impedance is calculated in accordance to JESD 51-7.

ESD Ratings

Item	Description	Value	Unit
V _(ESD-HBM)	Human Body Model (HBM) ANSI/ESDA/JEDEC JS-001-2014 Classification, Class: 2	±4000	V
V _(ESD-CDM)	Charged Device Mode (CDM) ANSI/ESDA/JEDEC JS-002-2014 Classification, Class: C0b	±200	V
I _{LATCH-UP}	JEDEC STANDARD NO.78E APRIL 2016 Temperature Classification, Class: I	±150	mA

ESD testing is performed according to the respective JESD22 JEDEC standard. The human body model is a 100 pF capacitor discharged through a 1.5kΩ resistor into each pin. The machine model is a 200pF capacitor discharged directly into each pin.

Recommended Operating Conditions

Parameter	MIN.	MAX.	Units
Supply voltage at V _{IN}	---	60	V
Operating junction temperature range, T _j	-40	125	°C
Operating free air temperature range, T _A	-40	85	°C

Note : All limits specified at room temperature (T_A = 25°C) unless otherwise specified. All room temperature limits are 100% production tested. All limits at temperature extremes are ensured through correlation using standard Statistical Quality Control (SQC) methods. All limits are used to calculate Average Outgoing Quality Level (AOQL).

Electrical Characteristics

(Test Conditions: $V_{IN} = V_{set} + 1V$, $V_{OUT} = V_{set}$, $C_{IN} = 10\mu F$, $C_{OUT} = 10\mu F$, $T_A = 25^\circ C$, unless otherwise specified.)

Parameter	Symbol	Conditions	Min	Typ	Max	Units
Input Voltage	V_{IN}				80	V
Supply Current	I_Q	$V_{IN} = 12V$ $I_{LOAD} = 0mA$	—	2.0	3.0	μA
Output Voltage HE2280 (A)	V_{OUT1}	$V_{IN} = 12V$ $I_{OUT} = 10mA$	$V_{set} * 0.99$	V_{set}	$V_{set} * 1.01$	V
Output Voltage HE2280 (B)	V_{OUT2}	$V_{IN} = 12V$ $I_{OUT} = 10mA$	$V_{set} * 0.98$	V_{set}	$V_{set} * 1.02$	V
Maximum Output Current	$I_{OUT(Max)}$	—	—	200	—	mA
Dropout Voltage	$V_{DROP}^{(1)}$ $V_{OUT} = 3.3V$	$V_{IN} = V_{set} - 0.1V$ $I_{OUT} = 10mA$	—	70	—	mV
		$V_{IN} = V_{set} - 0.1V$ $I_{OUT} = 100mA$	—	700	—	
Line Regulation	$\frac{\Delta V_{OUT}}{\Delta V_{IN} \cdot V_{OUT}}$	$I_{OUT} = 1mA$ $(V_{set} + 0.5V) \leq V_{IN} \leq 55V$	—	0.01	—	%/V
Load Regulation	ΔV_{OUT}	$V_{IN} = 12V$ $1mA \leq I_{OUT} \leq 100mA$	—	0.02	—	%/mA
Short Current	I_{SHORT}	$R_L = 1\Omega$	—	80	—	mA
Power Supply Rejection Rate	PSRR	$V_{IN} = 12V$ $V_{OUT} = 3.3V$ $f = 1KHz, I_{OUT} = 10mA$	—	70	—	dB
Output Noise Voltage	e_{NO}	$C_{OUT} = 1\mu F$ $BW = 300Hz \sim 50kHz$	—	50	—	μV_{RMS}
Output Voltage Temperature Coefficient	$\frac{\Delta V_{OUT}}{\Delta T \cdot V_{OUT}}$	$I_{OUT} = 10mA$	—	100	—	ppm/ $^\circ C$

Note: (1) Dropout Voltage is the voltage difference between the input and the output at which the output voltage drops 2% below its nominal value.

Typical Performance Characteristics:

Test Condition: $T_A=25^{\circ}\text{C}$, $I_{\text{out}}=1\text{mA}$, $C_{\text{out}}=10\mu\text{F}$, unless otherwise noted

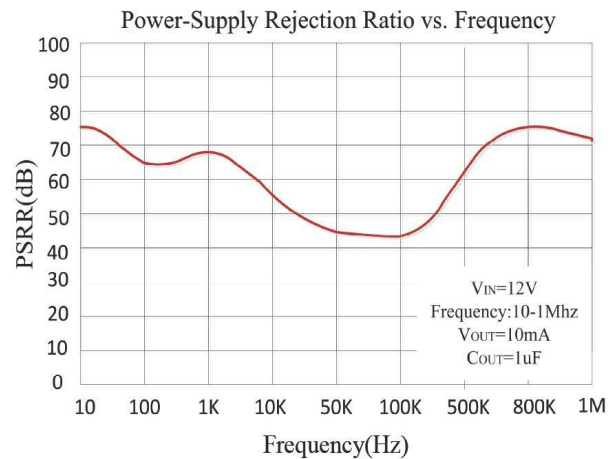
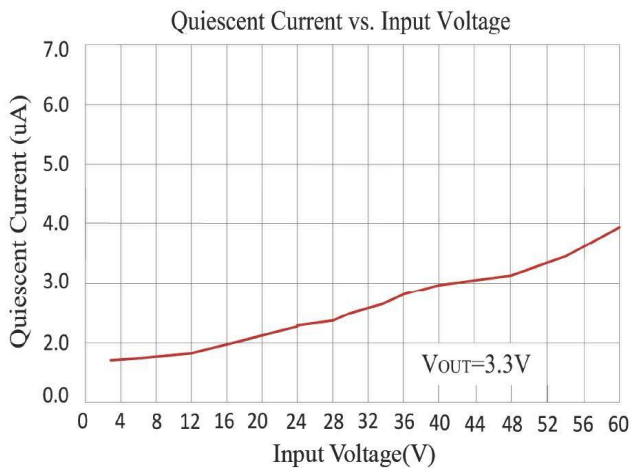
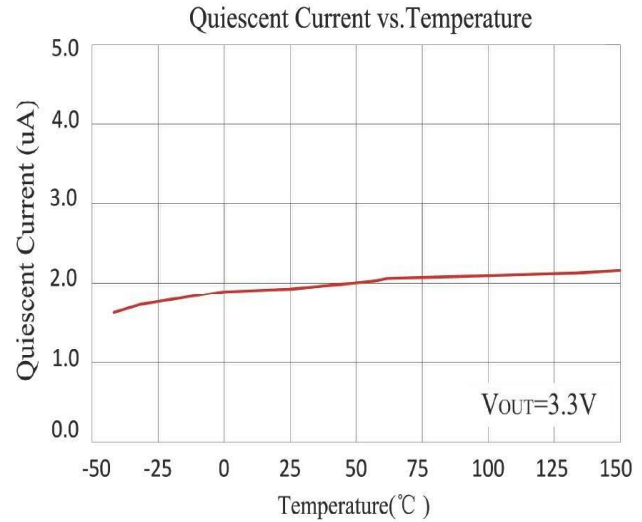
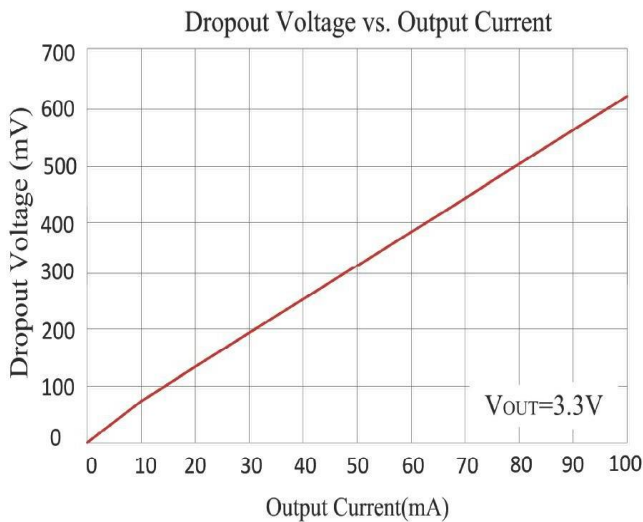
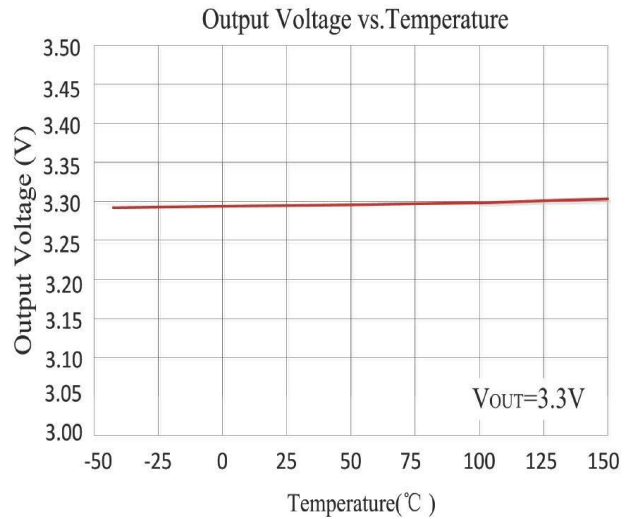
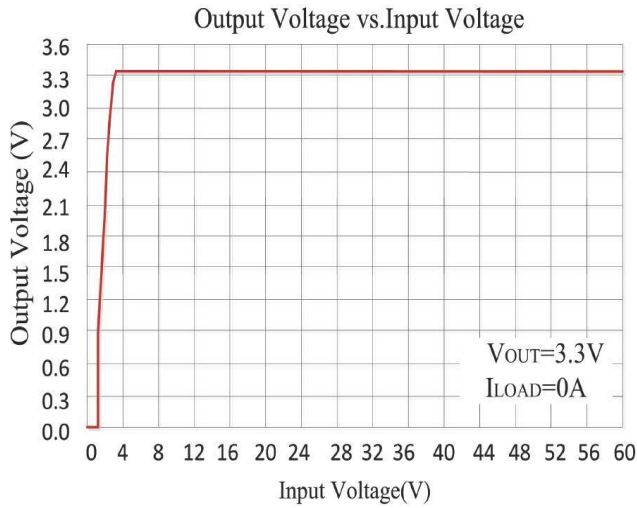

Line Transient Response

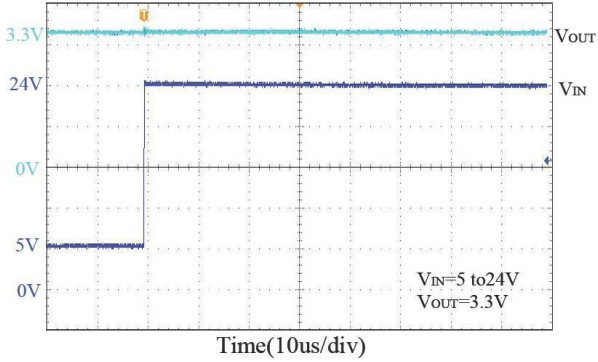

Line Transient Response

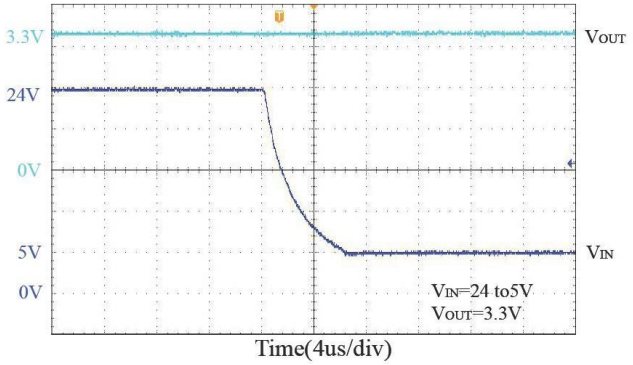

Load Transient Response

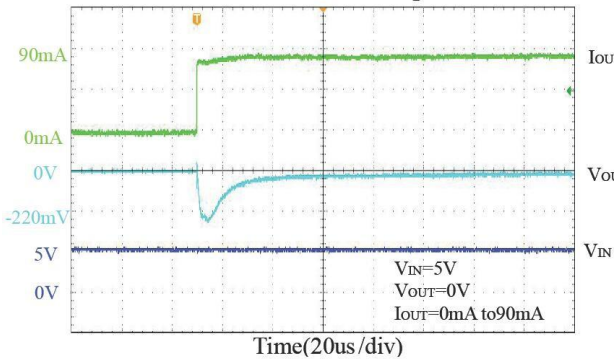

Load Transient Response

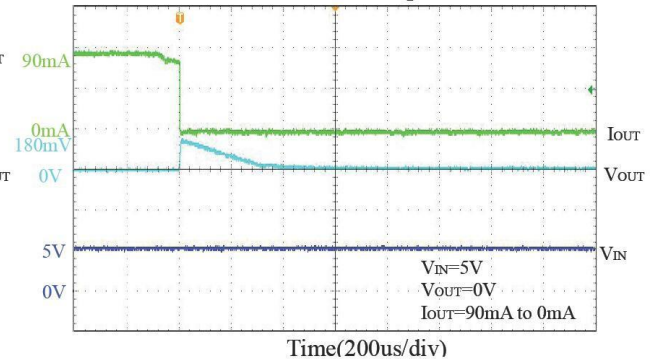

Start Up

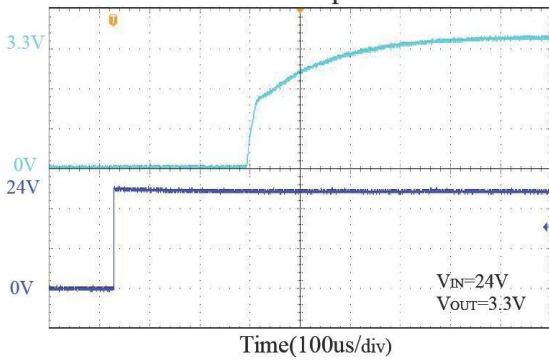

Start Up

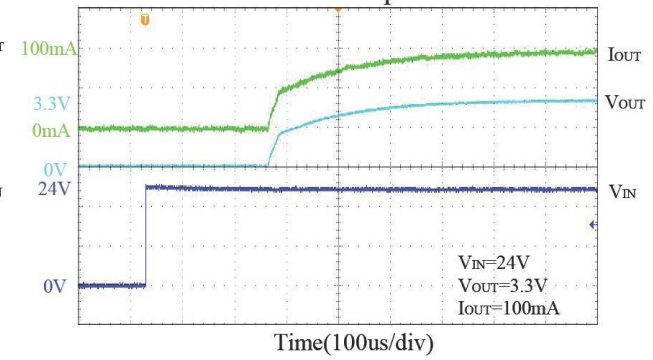

Short Circuit Protection

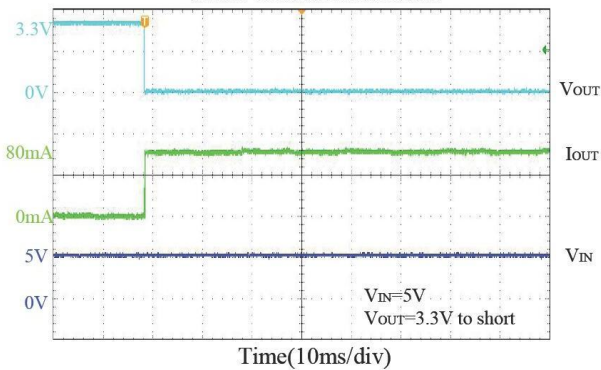

Short Circuit Protection

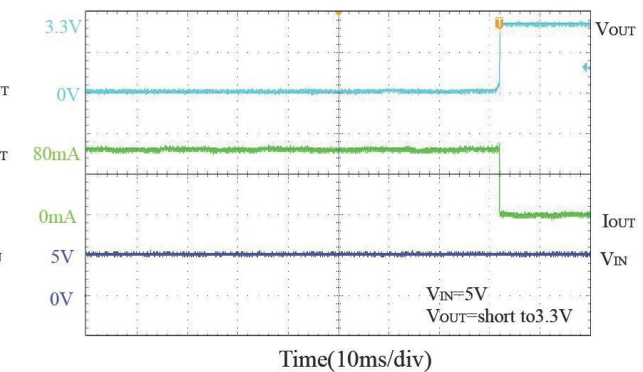

Application Guideline

Input Capacitor

A 10 μ F ceramic capacitor is recommended to connect between V_{DD} and GND pins to decouple input power supply glitch and noise. The amount of the capacitance may be increased without limit. This input capacitor must be located as close as possible to the device to assure input stability and less noise. For PCB layout, a wide copper trace is required for both VIN and GND.

Output Capacitor

An output capacitor is required for the stability of the LDO. The recommended output capacitance is 10 μ F, ceramic capacitor is recommended, and temperature characteristics are X7R or X5R. Higher capacitance values help to improve load/line transient response. The output capacitance may be increased to keep low undershoot/overshoot. Place output capacitor as close as possible to VOUT and GND pins.

Dropout Voltage

The dropout voltage refers to the voltage difference between the VIN and VOUT pins while operating at specific output current. The dropout voltage V_{DROP} also can be expressed as the voltage drop on the pass-FET at specific output current (I_{RATED}) while the pass-FET is fully operating at ohmic region and the pass-FET can be characterized as a resistance R_{DS(ON)}. Thus the dropout voltage can be defined as (V_{DROP} = V_{IN} - V_{OUT} = R_{DS(ON)} x I_{RATED}). For normal operation, the suggested LDO operating range is (V_{IN} > V_{OUT} + V_{DROP}) for good transient response and PSRR ability. Vice versa, while operating at the ohmic region will degrade the performance severely.

Thermal Application

For continuous operation, do not exceed the absolute maximum junction temperature. The maximum power dissipation depends on the thermal resistance of the IC package, PCB layout, rate of surrounding airflow, and difference between junction and ambient temperature. The maximum power dissipation can be calculated as below: TA=25°C, PCB,

The max PD= (125°C - 25°C) / (Thermal Resistance °C/W)

Power dissipation (PD) is equal to the product of the output current and the voltage drop across the output pass element, as shown in the equation below:

$$PD = (V_{IN} - V_{OUT}) \times I_{OUT}$$

Packaging Information

SOT23-3L

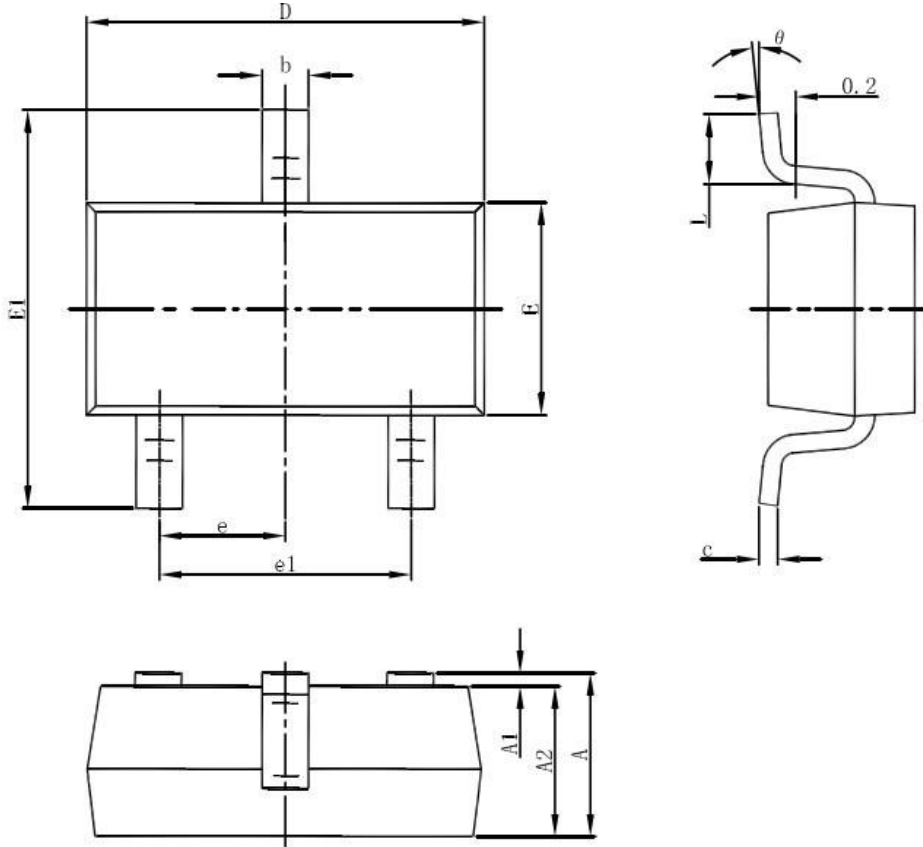

Symbol	Dimensions In Millimeters		Dimensions In Inches	
	Min	Max	Min	Max
A	1.050	1.250	0.041	0.049
A1	0.000	0.100	0.000	0.004
A2	1.050	1.150	0.041	0.045
b	0.300	0.500	0.012	0.020
c	0.100	0.200	0.004	0.008
D	2.820	3.020	0.111	0.119
E	1.500	1.700	0.059	0.067
E1	2.650	2.950	0.104	0.116
e	0.950(BSC)		0.037(BSC)	
e1	1.800	2.000	0.071	0.079
L	0.300	0.600	0.012	0.024
θ	0°	8°	0°	8°

3-pin SOT89 Outline Dimensions

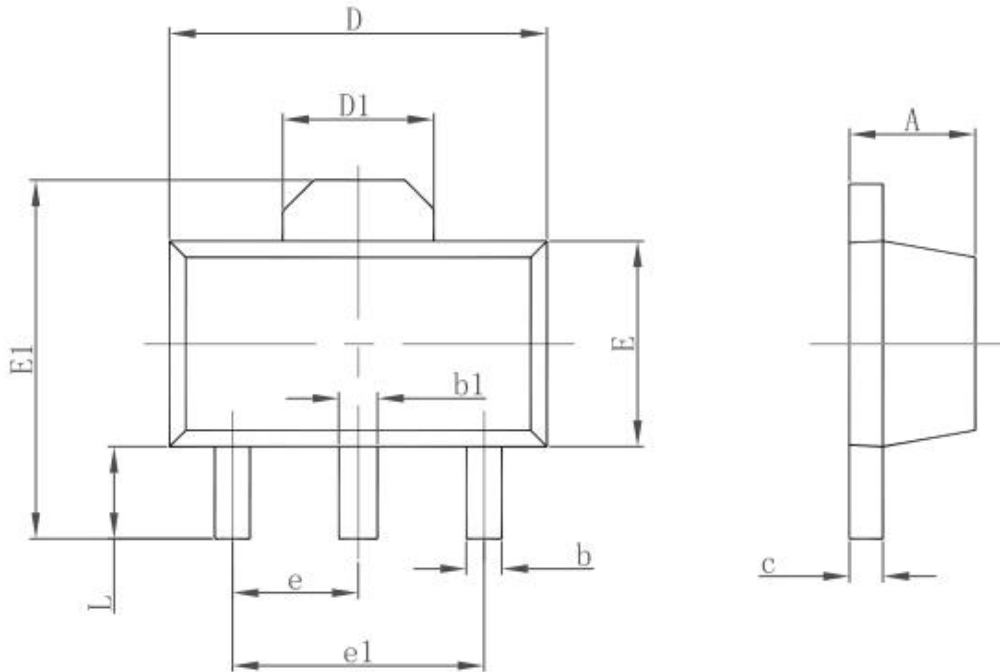

Symbol	Dimensions In Millimeters		Dimensions In Inches	
	Min.	Max.	Min.	Max.
A	1.400	1.600	0.055	0.063
b	0.320	0.520	0.013	0.020
b1	0.400	0.580	0.016	0.023
c	0.350	0.440	0.014	0.017
D	4.400	4.600	0.173	0.181
D1	1.550 REF.		0.061 REF.	
E	2.300	2.600	0.091	0.102
E1	3.940	4.250	0.155	0.167
e	1.500 TYP.		0.060 TYP.	
e1	3.000 TYP.		0.118 TYP.	
L	0.900	1.200	0.035	0.047