

MATING PLUG
Jack Insertion Depth: 8.95mm

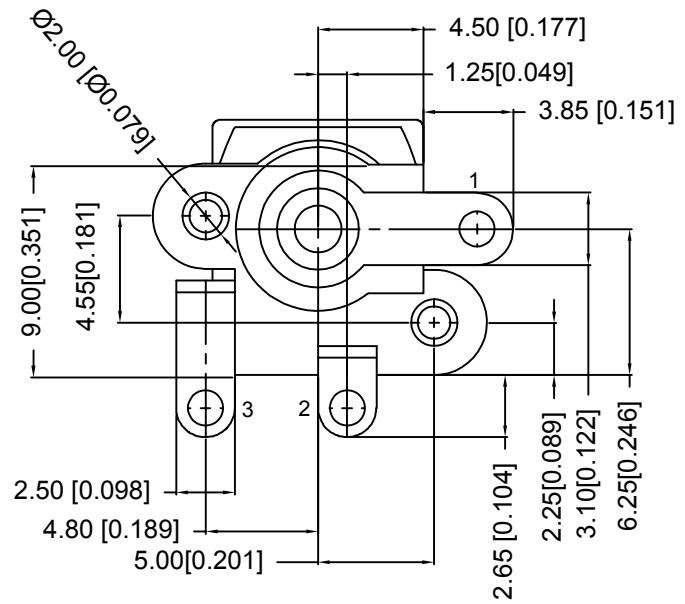
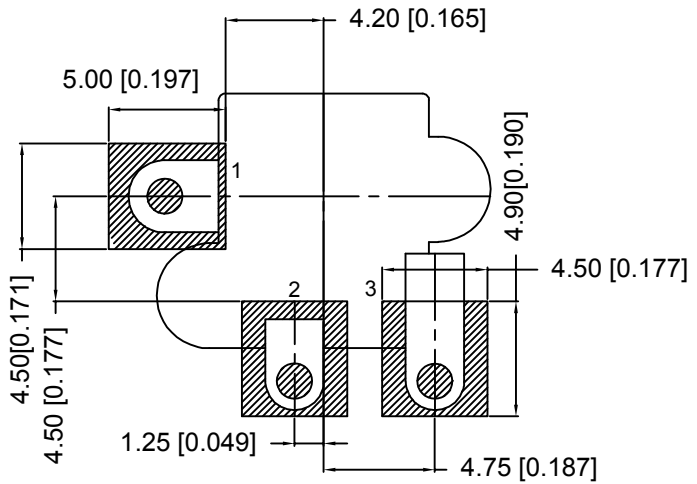

SCHEMATIC	
Model	DC-531
Center Pin	Ø2.0 mm
	Ø2.5 mm

	MATERIAL	PLATING
center pin	Brass	tin
terminal 1	Brass	tin
terminal 2	Phosphor Bronze	tin
terminal 3	Brass	tin
plastic	PA6T	

MARK	DESCRIPTION	DATE	REVISED	APPROVED	UNSPECIFIED TOLERANCES	DSND	DATE	SCALE: N/A	MODEL TYPE: DC POWER JACK		
					ANGULAR ±5°	DWN	DATE	VIEW:	PART NO.:		
Δx					X.X ±0.2mm	CHKD	DATE	UNIT: mm/in	DWG NO.:		
Δx					X.XX ±0.1mm	APPD	DATE	SIZE: A4	DC-531-2.5-SM1		
Δx					X.XXX ±0.05mm						
REVISIONS						XKB INDUSTRIAL PRECISION CO., LIMITED			WEIGHT	SHEET	REVISIO
www.xk-dg.cn www.helloxkb.com www.helloxkb.cn									1.0g	1/1	A0