

200V N-Channel Enhancement Mode MOSFET

Description

The AP40N20MP is silicon N-channel Enhanced VDMOSFETs, is obtained by the self-aligned planar Technology which reduce the conduction loss, improve switching performance and enhance the avalanche energy. The transistor can be used in various power switching circuit for system miniaturization and higher efficiency.

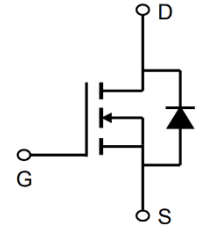

General Features

$V_{DS} = 200V, I_D = 40A$

$R_{DS(ON)} < 80m\Omega @ V_{GS} = 10V$

Application

Power amplifier

motor drive

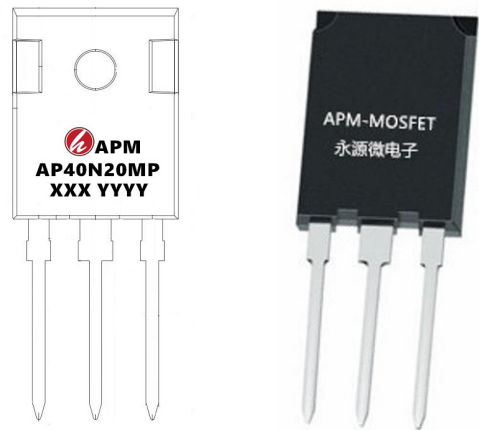

Package Marking and Ordering Information

Product ID	Pack	Marking	Qty(PCS)
AP40N20MP	TO-247-3 Plus	AP40N20MP XXX YYYY	600

Absolute Maximum Ratings $T_C = 25^\circ C$, unless otherwise noted

Symbol	Parameter	Value	Unit
VDSS	Drain-Source Voltage	200	V
ID	Drain Current -continuous	40	A
IDM	Drain Current -pulse	120	A
VGSS	Gate-Source Voltage	± 30	V
EAS	Single Pulsed Avalanche Energy	588	mJ
IAR	Avalanche Current	40	A
EAR	Repetitive Avalanche Current	15.8	mJ
dv/dt	Peak Diode Recovery dv/dt	5.5	V/ns
PD $T_C = 25^\circ C$	Power Dissipation	158	W
TJ, TSTG	Operating and Storage Temperature Range	$-55 \sim +150$	$^\circ C$
TL	Maximum Lead Temperature for Soldering Purposes	300	$^\circ C$
Rth(j-c)	Thermal Resistance, Junction to Case	0.79	$^\circ C/W$
Rth(j-A)	Thermal Resistance, Junction to Ambient	62.5	$^\circ C/W$

200V N-Channel Enhancement Mode MOSFET

Electrical Characteristics Diagrams

Symbol	Parameter	Tests conditions	Min	Typ	Max	Units
BV_{DSS}	Drain-Source Voltage	$I_D=250\mu A, V_{GS}=0V$	200	-	-	V
$\Delta BV_{DSS} / \Delta T_J$	Breakdown Voltage Temperature Coefficient	$I_D=250\mu A$, referenced to 25°C	-	0.19	-	V/°C
$IDSS$	Zero Gate Voltage Drain Current	$V_{DS}=200V, V_{GS}=0V, T_C=25^\circ C$	-	-	1	μA
$IGSSF$	Gate-body leakage current, forward	$V_{DS}=0V, V_{GS}=30V$	-	-	100	nA
$IGSSR$	Gate-body leakage current, reverse	$V_{DS}=0V, V_{GS}=-30V$	-	-	-100	nA
$V_{GS(th)}$	Gate Threshold Voltage	$V_{DS} = V_{GS}, I_D=250\mu A$	2.0	-	4.0	V
$R_{DS(ON)}$	Static Drain-Source On-Resistance	$V_{GS} = 10V, I_D=14.0A$	-	60	80	m Ω
g_{fs}	Forward Transconductance	$V_{DS} = 40V, I_D=14.0A$	-	24	-	S
C_{iss}	Input capacitance	$V_{DS}=25V, V_{GS} = 0V, f=1.0MHz$	-	2879	3742	pF
C_{oss}	Output capacitance		-	362	470	pF
C_{rss}	Reverse transfer capacitance		-	81	105	pF
$t_{d(on)}$	Turn-On delay time	$V_{DD}=100V, I_D=28A, R_G=25\Omega, V_{GS}=10V$ (note 4, 5)	-	28	69	ns
t_r	Turn-On rise time		-	251	494	ns
$t_{d(off)}$	Turn-Off delay time		-	309	617	ns
t_f	Turn-Off Fall time		-	220	412	ns
Q_{gi}	Total Gate Charge	$V_{DS} = 160V, I_D=28A$ $V_{GS} = 10V$ (note 4, 5)	-	103	136	nC
Q_{gs}	Gate-Source charge		-	16	-	nC
Q_{gd}	Gate-Drain charge		-	53	-	nC
I_S	Maximum Continuous Drain-Source Diode Forward Current		-	-	28	A
ISM	Maximum Pulsed Drain-Source Diode Forward Current		-	-	112	A
V_{SD}	Maximum Continuous Drain-Source Diode Forward Current	$V_{GS}=0V, I_S=28A$	-		1.4	V
t_{rr}	Reverse recovery time	$V_{GS}=0V, I_S=28A, di_F/dt=100A/\mu s$ (note 4)		218		ns
Q_{rr}	Reverse recovery charge			1.91		μC

Notes:

- 1: Pulse width limited by maximum junction temperature
- 2: $L=1.5mH, I_{AS}=28A, V_{DD}=50V, R_G=25\Omega$, Starting $T_J=25^\circ C$
- 3: $I_{SD} \leq 28A, di/dt \leq 200A/\mu s, V_{DD} \leq BV_{DSS}$, Starting $T_J=25^\circ C$
- 4: Pulse Test: Pulse Width $\leq 300\mu s$, Duty Cycle $\leq 2\%$
- 5: Essentially independent of operating temperature

200V N-Channel Enhancement Mode MOSFET

Electrical Characteristics Diagrams

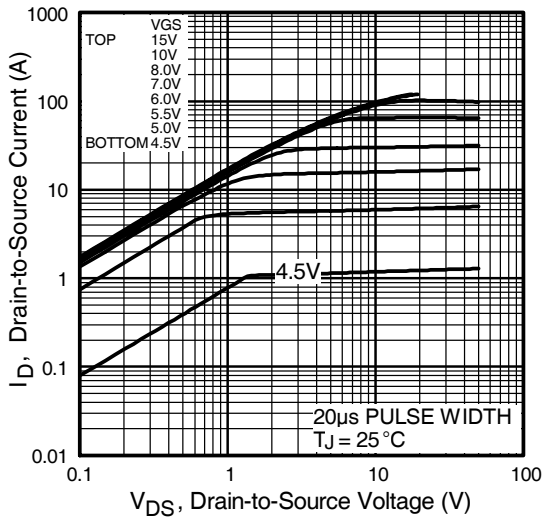

Fig 1. Typical Output Characteristics

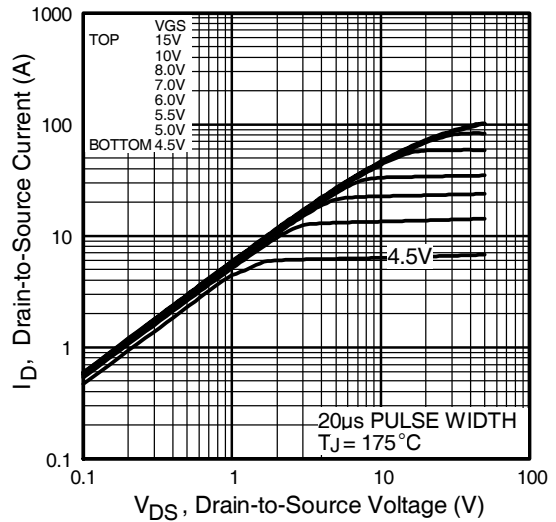

Fig 2. Typical Output Characteristics

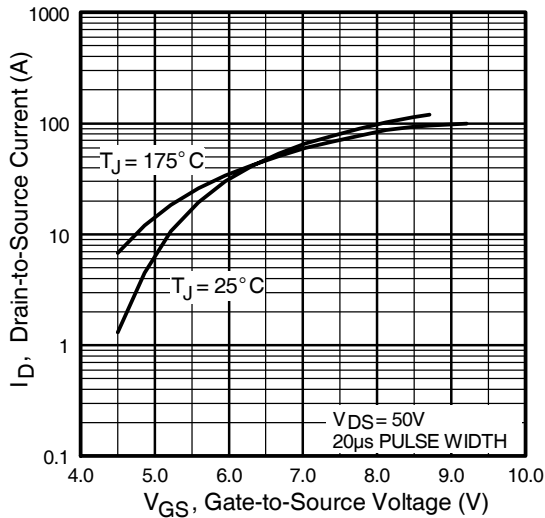

Fig 3. Typical Transfer Characteristics

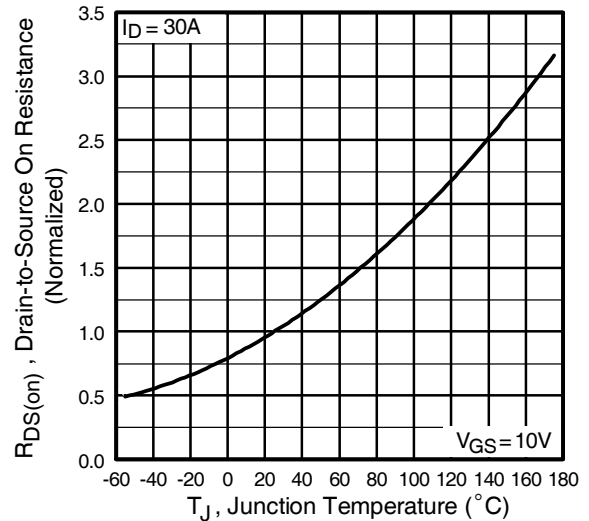

Fig 4. Normalized On-Resistance Vs. Temperature

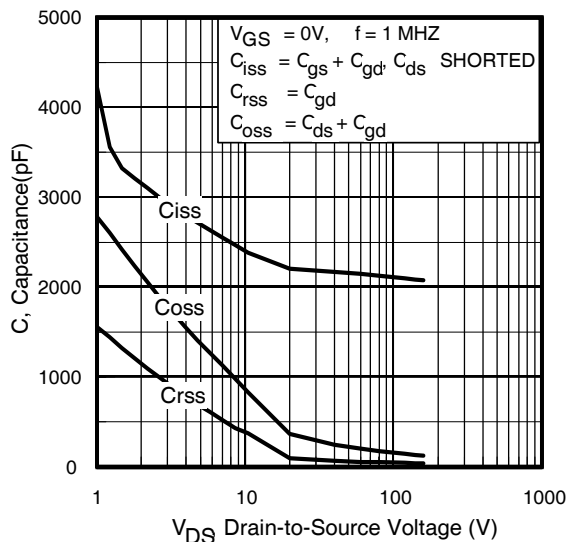

Fig 5. Typical Capacitance Vs. Drain-to-Source Voltage

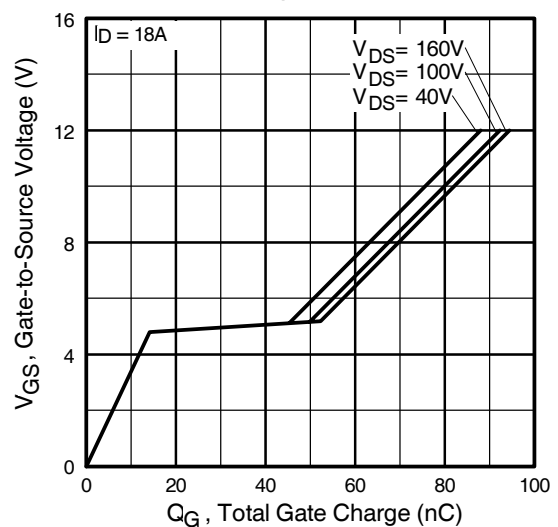

Fig 6. Typical Gate Charge Vs. Gate-to-Source Voltage

200V N-Channel Enhancement Mode MOSFET

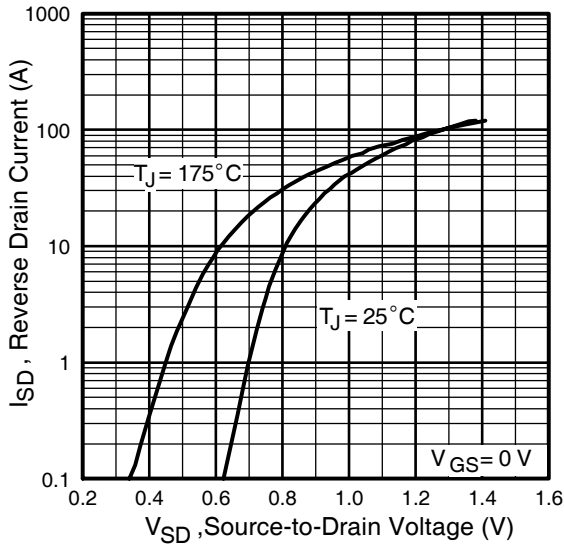

Fig 7. Typical Source-Drain Diode Forward Voltage

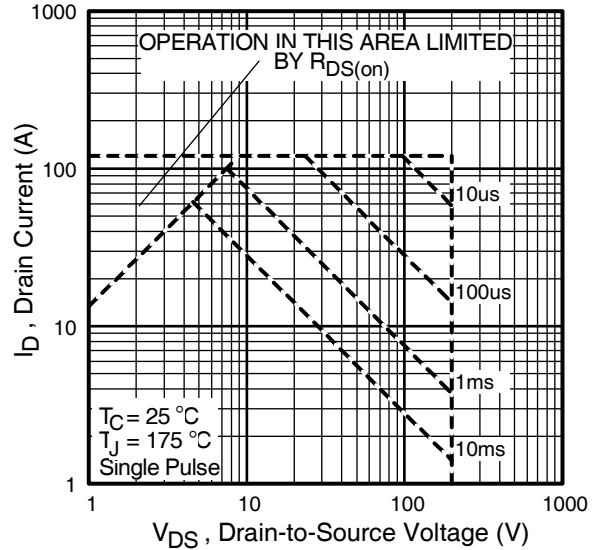

Fig 8. Maximum Safe Operating Area

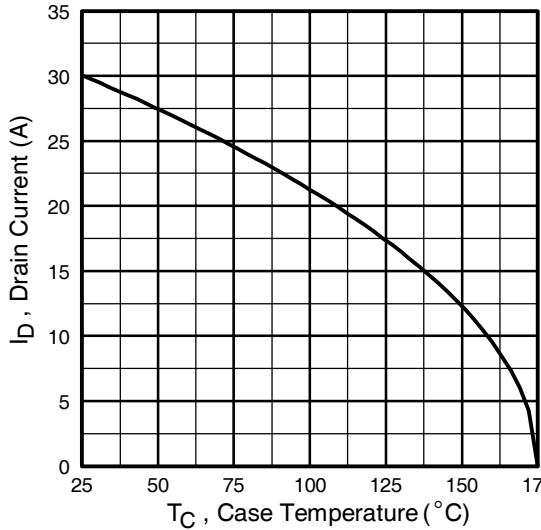

Fig 9. Maximum Drain Current Vs. Case Temperature

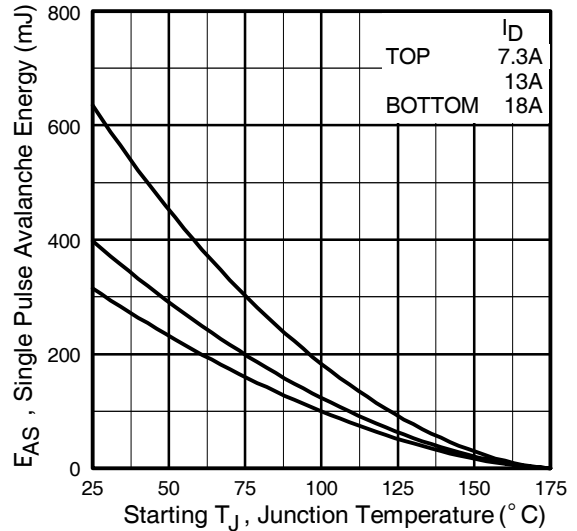

Fig 12c. Maximum Avalanche Energy Vs. Drain Current

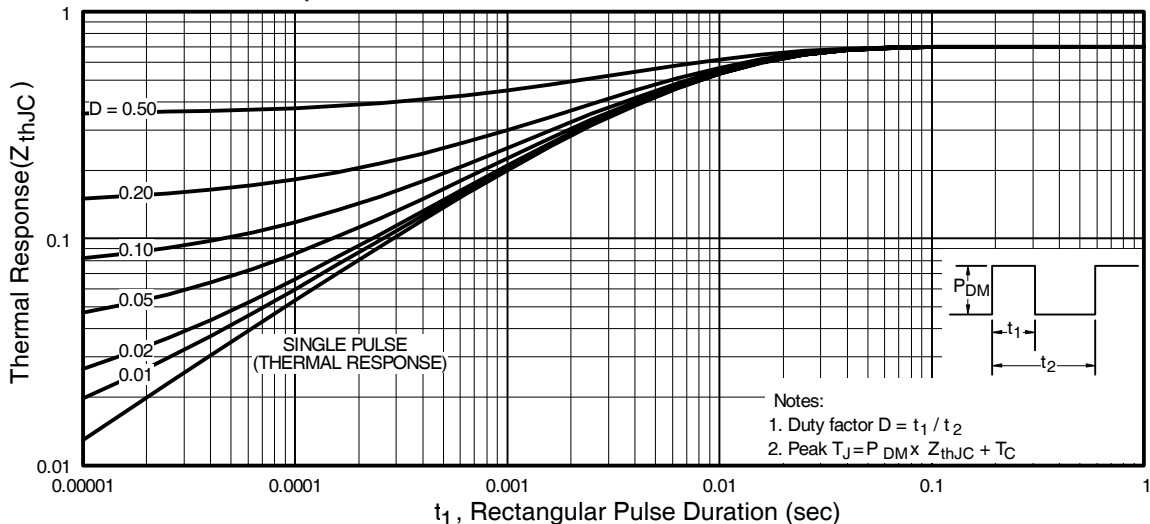
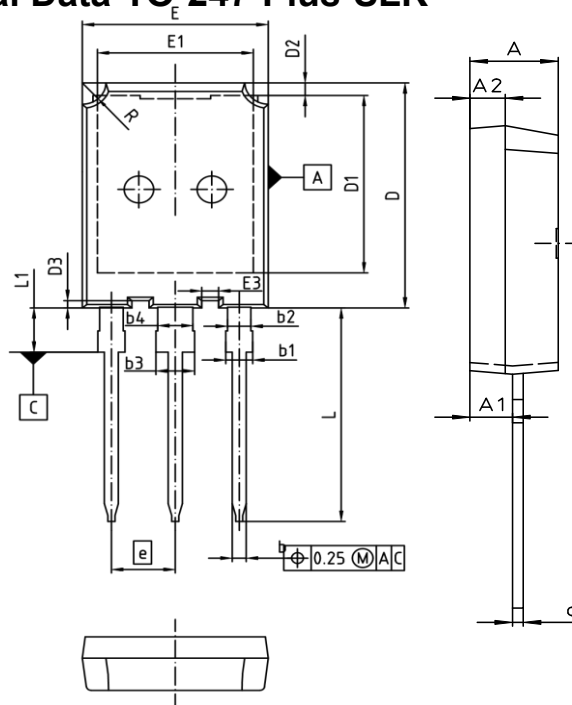

Fig 11. Maximum Effective Transient Thermal Impedance, Junction-to-Case

Package Mechanical Data-TO-247-Plus-SLK



DIM	MILLIMETERS		INCHES	
	MIN	MAX	MIN	MAX
A	4.90	5.10	0.193	0.201
A1	2.31	2.51	0.091	0.099
A2	1.90	2.10	0.075	0.083
b	1.16	1.26	0.046	0.050
b1	1.96	2.25	0.077	0.089
b2	1.96	2.06	0.077	0.081
c	0.59	0.66	0.023	0.026
D	20.90	21.10	0.823	0.831
D1	16.25	16.85	0.640	0.663
D2	1.05	1.35	0.041	0.053
D3	0.58	0.78	0.023	0.031
E	15.70	15.90	0.618	0.626
E1	13.10	13.50	0.516	0.531
E3	1.35	1.55	0.053	0.061
e	5.44 (BSC)		0.214 (BSC)	
N	3		3	
L	19.80	20.10	0.780	0.791
L1	-	4.30	-	0.169
R	1.90	2.10	0.075	0.083

200V N-Channel Enhancement Mode MOSFET**Attention**

1, Any and all APM Microelectronics products described or contained herein do not have specifications that can handle applications that require extremely high levels of reliability, such as life support systems, aircraft's control systems, or other applications whose failure can be reasonably expected to result in serious physical and/or material damage. Consult with your APM Microelectronics representative nearest you before using any APM Microelectronics products described or contained herein in such applications.

2, APM Microelectronics assumes no responsibility for equipment failures that result from using products at values that exceed, even momentarily, rated values (such as maximum ratings, operating condition ranges, or other parameters) listed in products specifications of any and all APM Microelectronics products described or contained herein.

3, Specifications of any and all APM Microelectronics products described or contained here instipulate the performance, characteristics, and functions of the described products in the independent state, and are not guarantees of the performance, characteristics, and functions of the described products as mounted in the customer's products or equipment. To verify symptoms and states that cannot be evaluated in an independent device, the customer should always evaluate and test devices mounted in the customer's products or equipment.

4, APM Microelectronics Semiconductor CO., LTD. strives to supply high quality high reliability products. However, any and all semiconductor products fail with some probability. It is possible that these probabilistic failures could give rise to accidents or events that could endanger human lives that could give rise to smoke or fire, or that could cause damage to other property. When designing equipment, adopt safety measures so that these kinds of accidents or events cannot occur. Such measures include but are not limited to protective circuits and error prevention circuits for safe design, redundant design, and structural design.

5, In the event that any or all APM Microelectronics products (including technical data, services) described or contained herein are controlled under any of applicable local export control laws and regulations, such products must not be exported without obtaining the export license from the authorities concerned in accordance with the above law.

6, No part of this publication may be reproduced or transmitted in any form or by any means, electronic or mechanical, including photocopying and recording, or any information storage or retrieval system, or otherwise, without the prior written permission of APM Microelectronics Semiconductor CO., LTD.

7, Information (including circuit diagrams and circuit parameters) herein is for example only; it is not guaranteed for volume production. APM Microelectronics believes information herein is accurate and reliable, but no guarantees are made or implied regarding its use or any infringements of intellectual property rights or other rights of third parties.

8, Any and all information described or contained herein are subject to change without notice due to product/technology improvement, etc. When designing equipment, refer to the "Delivery Specification" for the APM Microelectronics product that you intend to use.