

# SPECIFICATION FOR APPROVAL

REF. :

PROD. NAME	SMD Line Filter	ABC'S DWG NO.	SF0905□□□□L□-□□□		
		REV.	20191122-G	PAGE	1

## I . Configuration and dimensions :

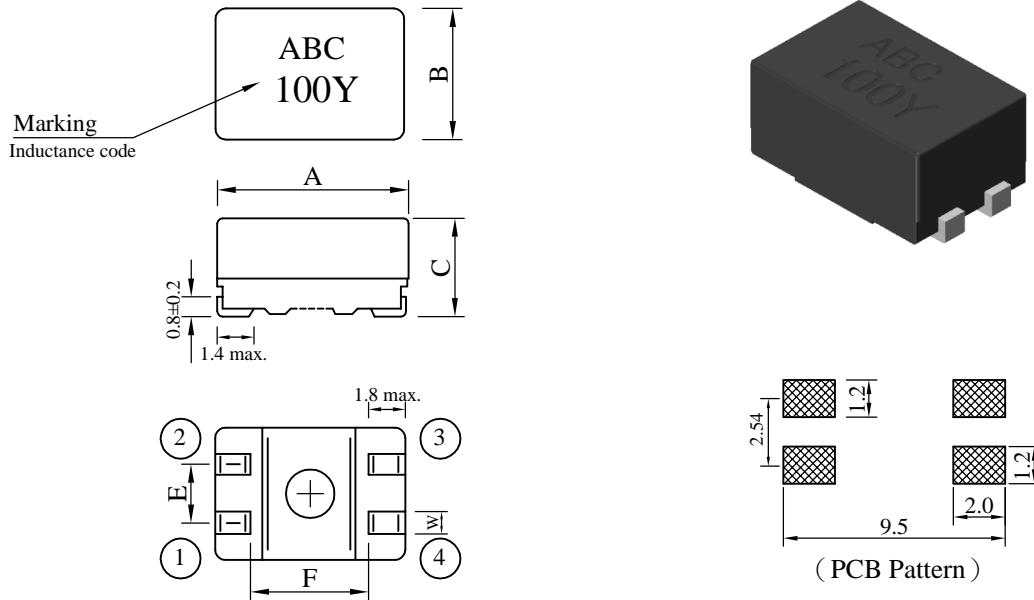

Unit : mm

A	B	C	E	F	W
9.20 ±0.3	6.00 ±0.3	5.00 ±0.3	2.54 ±0.2	5.70 ref.	1.00 ±0.1

## II . Schematic diagram :

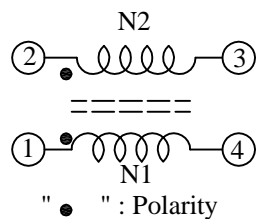

## III . Description :

- a . Ferrite toroidal core construction.
- b . Enamelled copper wire : H class
- c . Product weight : 0.42g ( ref. )
- d . Moisture sensitivity Level 1
- e . Products comply with RoHS' requirements
- f . Halogen free

## IV . General specification :

- a . Storage temp. : -40°C ----+105°C
- b . Operating temp. : -40°C ----+105°C  
(Temp. rise included)
- c . Resistance to solder heat : 260°C .10 secs.

Peak Temp : 250°C max.  
Max. Peak Temp - 5°C : 30sec max.  
Max time above 217°C : 60sec~150sec max.

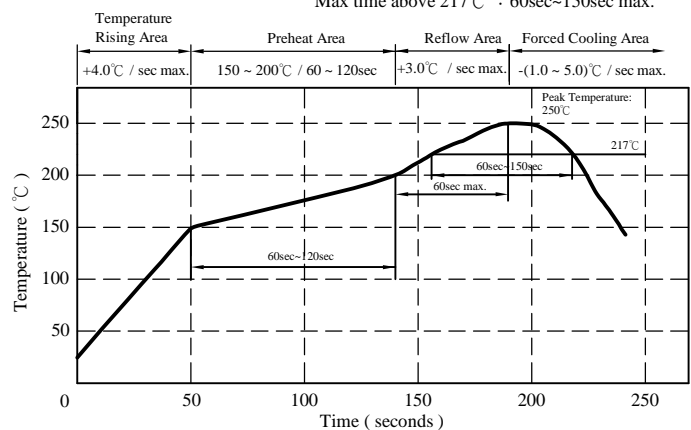

AR-001C

# SPECIFICATION FOR APPROVAL

REF. :

PROD. NAME	SMD Line Filter	ABC'S DWG NO.	SF0905□□□□L□-□□□		
		REV.	20191122-G	PAGE	2

V . Electrical characteristics :

DWG. No.	Indductance L1 , L2 ( $\mu$ H )	Test condition	DC Resistance N1,N2 ( $\Omega$ )	Nominal Voltage Vdc ( V )	Rated current ( A )	Impedance ( $\Omega$ )	Freq. Range ( MHz )
SF0905100YL□-□□□	10 $\pm$ 30%	0.1V,1kHz	0.08 max.	80	1.6	200 min.	20 ~ 300
SF0905250YL□-□□□	25 $\pm$ 30%	0.1V,1kHz	0.16 max.	80	1.0	600 min.	20 ~ 150
SF0905400YL□-□□□	40 $\pm$ 30%	0.1V,1kHz	0.25 max.	80	0.9	800 min.	20 ~ 100
SF0905500YL□-□□□	50 $\pm$ 30%	0.1V,1kHz	0.32 max.	80	0.8	1500 min.	20 ~ 100
SF0905251YL□-□□□	250 $\pm$ 50%	5mV,100kHz	0.13 max.	80	1.2	600 min.	3 ~ 20
SF0905471YL□-□□□	470 $\pm$ 50%	5mV,100kHz	0.14 max.	80	1.1	1000 min.	2 ~ 20
SF0905501YL□-□□□	500 $\pm$ 50%	5mV,100kHz	0.15 max.	80	1.0	1000 min.	1 ~ 20
SF0905102YL□-□□□	1000 $\pm$ 50%	5mV,100kHz	0.31 max.	80	0.8	1500 min.	1 ~ 15
SF0905202YL□-□□□	2000 $\pm$ 50%	5mV,100kHz	0.42 max.	80	0.6	3000 min.	1 ~ 5
SF0905472YL□-□□□	4700 $\pm$ 50%	5mV,100kHz	0.90 max.	80	0.4	4000 min.	0.3 ~ 3
SF0905652YL□-□□□	6500 $\pm$ 50%	5mV,100kHz	1.05 max.	80	0.3	5000 min.	0.3 ~ 2

- 1). Electrical specifications at 25°C
- 2). Irms base on Temp. rise 45°C max.
- 3). HI-Pot test ( N1-N2 ) : 500Vac / 60Hz , 3mA , 3sec.

VI . Curve :

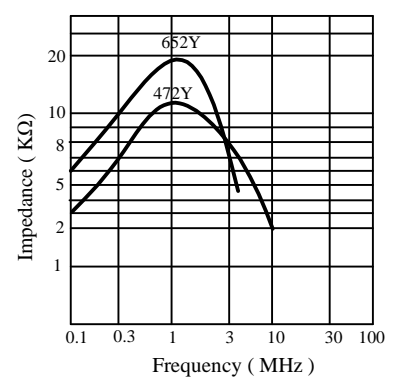
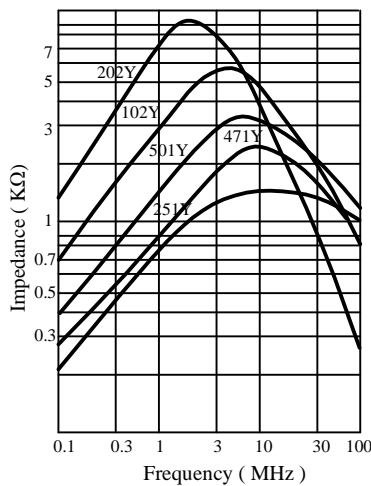
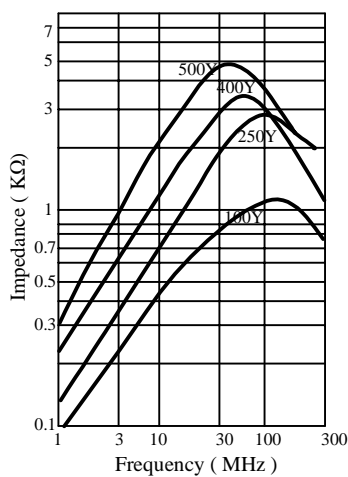

Measuring circuit :

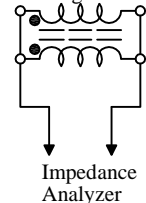

# SPECIFICATION FOR APPROVAL

REF. :

PROD. NAME	SMD Line Filter	ABC'S DWG NO.	SF0905□□□□L□-□□□		
		REV.	20191122-G	PAGE	3

## VII . Packaging information :

### (1) Configuration

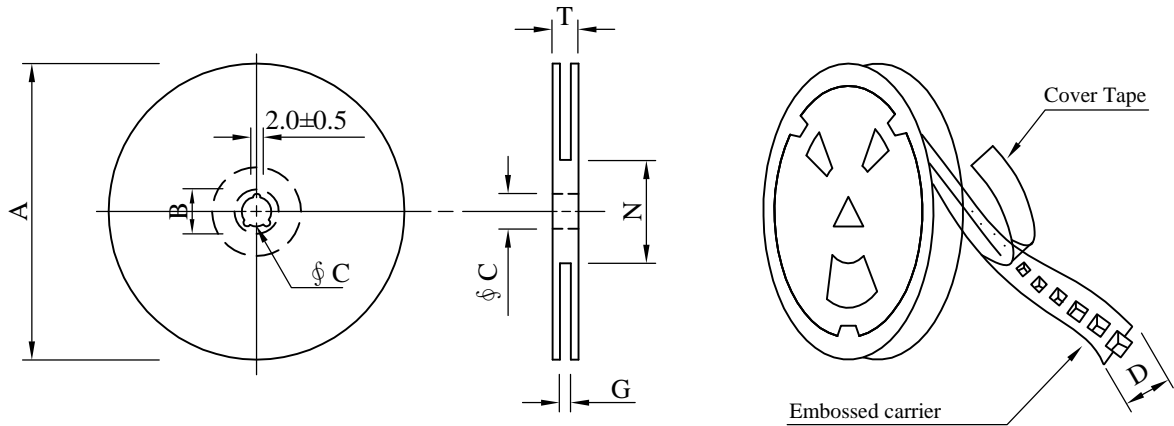

※Carrier tape width : D

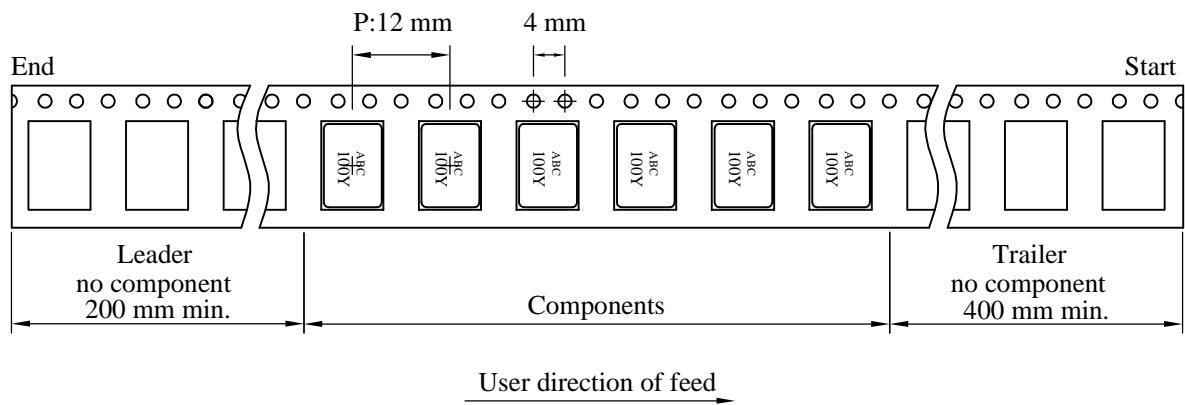

### (2) Dimensions

Unit:mm

Style	A	B	C	D	G	N	T
13 - 16	330	21±0.8	13±0.5	16	18 <sup>+0</sup>	50 <sup>-0</sup>	22.4

### (3) Q'TY & G.W. Per package

Code	Inner : Reel			Outer : Carton		
	Q'TY (pcs)	G.W. (g)	Style	Q'TY (pcs)	G.W. (kg)	Size (cm)
B	1,000	860	13 - 16	6,000	6.5	38 x 37 x 22

AR-001C

# SPECIFICATION FOR APPROVAL

REF. :

PROD. NAME	SMD Line Filter	ABC'S DWG NO.	SF0905□□□□L□-□□□		
		REV.	20191122-G	PAGE	4

VIII . Drawing number expression :

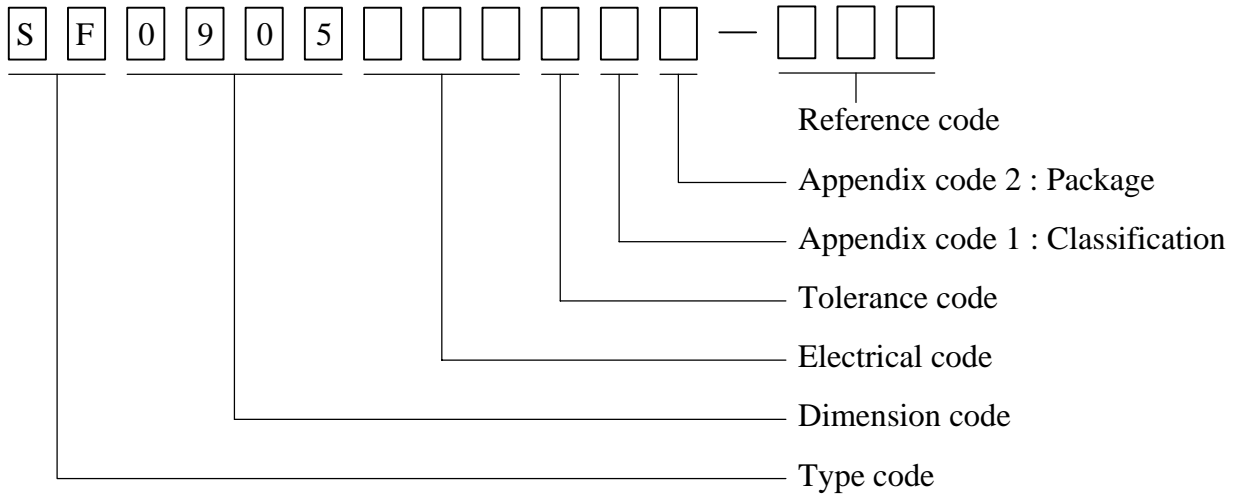

Appendix code 1 : Product Classification

Appendix code 2 : Package Information

Code	Inner package	Cover tape	Carrier tape	Bag	Package Q'TY	Remark
B	T /R (Reel package)	UCT	Antistatic	Antistatic	1000 pcs	

# SPECIFICATION FOR APPROVAL

REF. :

PROD. NAME	SMD Line Filter	ABC'S DWG NO.	SF0905□□□□L□-□□□		
		REV.	20191122-G	PAGE	5

## IX . Reliability test :

Item	Reference documents	Test Condition	Test Specification
1.High Temperature Exposure	MIL-STD-202 Method 108	1.Temperature: 105±2°C 2.Time:96±2 hours.	1.No mechanical or electrical damage. 2.Inductance shall not change more than ±50%.
2.Temperature Cycling	JESD22-A 104	1.Temperature: -40°C ~ +105°C 2.Number of cycle:100 cycle 3.Dwell time:30 minutes	1.No mechanical or electrical damage. 2.Inductance shall not change more than ±50%.
3.Biased Humidity Test	MIL-STD-202 Method 103	1.Temperature : 85±2°C 2.Humidity: 85% RH. 3.Time:96±2 Hours	1.No mechanical or electrical damage. 2.Inductance shall not change more than ±50%.
4.Operational Life	JESD22-A 108	1.Temperature: 105°C (Temp. rise included) 2.Time:96±2 hours. 3.Rated current	1.No mechanical or electrical damage. 2.Inductance shall not change more than ±50%.
5.External Visual	JESD22-B 101 & MIL-STD-883 Method 2009	Inspect product constructions, marking and workmanship.	1.No pollution on the surface of products. 2.Clear marking. 3.No crack.
6.Physical Dimensions	JESD22-B 100	Verify physical dimensions to the applicable product detail specification.	Per product specification standard
7.Resistance to solvents	MIL-STD-202 Method 215	Immerse into solvent for 3±0.5 minutes & brush 10 times for 3 cycles.	1.No body change in appearance. 2.No marking blurred. 3.Inductance shall not change more than ±50%.
8.Vibration Test	MIL-STD-202 Method 204	1.Frequency and Amplitued : 10-2000-10 Hz, 1.5 mm. 2.Direction:X, Y, Z 3.Test duration:2 hours for each direction, 6 hours in total.	1.No mechanical or electrical damage. 2.Inductance shall not change more than ±50%.
9.Resistance To Soldering Heat Test	MIL-STD-202 Method 210 & J-STD020D.1	1.Highest temperature : 250±5°C. 2.Time ( temp. ≥ 217°C ) : 60~150 Seconds. 3.IR reflow times : 3 times.	1.No mechanical or electrical damage. 2.Inductance shall not change more than ±50%.
10.Over load	JIS C 6436 & User SPEC.	1.Applied one and half rated current for a period of 5 minutes. 2.Rated current	No electrical or mechanical damage
11. Temperature Rise Current	JIS C 6436 & User SPEC.	1.Applied rated current for 10 minutes. 2.Temperature measure by digital surface thermometer. 3.Irms current	Surface temperature rise is less than 45°C max.
12.Solderability Test	J-STD-002 & JESD22-B 102	1.Baking in pre-testing : 150±5°C / 16Hours±30 min. 2.Peak temperature : 240±5°C 3.Time ( temp. ≥ 217°C ) : 60~150 seconds. 4.IR reflow times : 1 time.	More than 95% soldering coverage min on terminations.
13.Electrical Characteriazation	MIL-STD-202 Method 304 & User SPEC.	1.Operating temperature : -40°C~105°C 2.Room temperature : 25°C.	1.No mechanical or electrical damage. 2.Inductance shall not change more than ±50%.
14.Withstanding Voltage Test	MIL-STD-202 Method 301 & User SPEC.	1.AC: 500 V (Winding to Winding) 2.Time : 3sec.	1.During the test no breakdown. 2.No mechanical or electrical damage.
15.Drop	CNS-C6354 & GB/T 2423.8	1.Products shall be mounted on SPEC. PCB and dropped down from a height of 1m 2.Drop total time : 6 times (Every side of sample drop 2 times)	1. Adhesion on PCB shall be enough. 2. Product appearance shall not break. 3. No electrical damage.
16.Terminal Strength Test	IEC 60068-2-21	1.Apply push force to samples mounted on PCB. 2.Force of 1.8 kg for 60±1 seconds.	After test, inductors shall be no mechanical damage.

AR-001C