

可任意限幅、内置自适应升压的2×8.0W立体声音频功放

2×8.0W Audio Amplifier with Class H Boost Converter and Limiter

■ FEATURES

- Flexible Limiter Function adjusted by external resistor so that the output music is limited under a preset THD+N and power
- Integrated Thermal Foldback (TFB) Function that significantly increases the peak audio power
- Integrated adaptive class G Boost Converter that extends the play time in battery supply applications
 - Adjustable switch peak current limit to avoid over-pulling on battery current
 - Adjustable max boost voltage
- Both Class D and Class AB is available
- THD+N: 0.04% ($R_L=4\Omega$, $f_{IN}=1\text{kHz}$, $P_o=2\times 1.0W$)
- Low Quiescent Current: 7mA, 3.7V
- Output Power ($V_{BAT}=4.2V$, $f_{IN}=1\text{kHz}$, $R_L=4\Omega$)
 - 2×6.8W (continuous power, $V_{POUT}=8.3V$, THD+N = 1%)
 - 2×8.4W (instantaneous power, $V_{POUT}=8.3V$, THD+N = 10%)
- Power Supply V_{BAT} : 2.8V~5.5V
- Multiple Gain Available: 21dB, 25.5dB, 30dB
- Filter-less Modulation
- Thermal/Low voltage malfunction prevention function with auto recovery
- Pb-free Packages, TSSOP24L-PP
- 可任意配置的限幅功能
 - 自由配置音频限制幅度，使输出音频信号限制在固定失真水平内
- 内置自动限温控制功能
 - 适应不同散热条件，避免出现过温关断现象
- 高效自适应G类升压功能，有效延长播放时间
 - 可调节最大限流值，有效防止电池拉死
 - 升压值可调
- 支持AB类与D类切换
- THD+N: 0.04% ($R_L=4\Omega$, $f_{IN}=1\text{kHz}$, $P_o=2\times 1.0W$)
- 低静态电流：7mA, 3.7V
- 输出功率($V_{BAT}=4.2V$, $f_{IN}=1\text{kHz}$, $R_L=4\Omega$)
 - 2×6.8W ($V_{POUT}=8.3V$, THD+N= 1%, 连续输出)
 - 2×8.4W ($V_{POUT}=8.3V$, THD+N = 10%, 瞬态输出)
- V_{BAT} 供电范围：2.8V至5.5V
- 三种增益选择：21dB, 25.5dB, 30dB
- 免滤波器数字调制，直接驱动扬声器
- 保护功能：过流/过热/欠压异常保护功能
- 无铅无卤封装，TSSOP24L-PP

■ APPLICATIONS

- Smart Speakers
- Wireless Speakers
- 智能音响
- 无线音响
- 便携式音箱
- Portable Speakers
- 2.1Channel Speakers
- 2.1声道小音箱
- 拉杆音箱
- 便携式游戏机
- Megaphone
- Portable Gamers

■ ORDERING INFORMATION

Part Number	Package Type	Marking	Operating Temperature Range	MOQ/Shipping Package
HT878TMTER	TSSOP24L-PP	HT878T ^{MTE} UVWXYZ ¹	-40℃~85℃	Tape and Reel 3000PCS
HT878TMTET	TSSOP24L-PP	HT878T ^{MTE} UVWXYZ	-40℃~85℃	Tube 38PCS

¹ UVWXYZ is production tracking code

DESCRIPTION

The HT878T is a stereo Class D audio amplifier that drives up to continuous $2 \times 6.8W$ (1% THD+N, boosted to 8.3V) into 4ohm speaker. It also integrates Class AB amplifier to avoid EMI.

HT878T built-in Class G boost converter supports adjustable boost voltages. The boost converter is automatically active only when a higher audio output power is required, which will significantly improve the efficiency and extends the playing time in battery supply applications.

HT878T integrates Limiter function. When it is active, the output music can be limited below a certain power and THD+N. This will allow different demands in sound performance and prevent speakers from damage.

The Thermal Foldback (TFB) function is designed to protect the HT878T from excessive die temperature in case of the device being operated beyond the recommended temperature or power limit, or with a weaker thermal system than recommended. The TFB works by reducing the on-die power dissipation by reducing Gain if the temperature trig point is exceeded, so that the peak audio power is significantly increased.

HT878T has a filter-less modulation circuit which can directly drive speakers. HT878T can be shut down so that the power consumption can be minimized. As for protection function, over current protection function for speaker output terminals, over temperature protection function and low supply voltage malfunction preventing function are also prepared.

HT878T是一款内置自适应升压的立体声D类音频功率放大器，由锂电池供电升压至 $V_{POUT}=8.3V$ 时，THD+N=1%、1kHz信号条件下，能连续输出 $2 \times 6.8W$ 功率（4Ω负载）；另外，其还支持AB类模式。

HT878T内置G类升压，可任意设置最大升压值，以满足不同的输出功率需求。该升压在小音乐信号时不升压，仅当功率较大时工作。其可大幅提高系统效率，延长电池续航时间。

HT878T具有可任意配置的限幅(Limiter)功能。限幅功能开启后，即使输入信号很大，音乐输出也能被限制在指定的功率和THD+N之内，满足不同音质体验和保护喇叭的需求。

HT878T还具有自动限温控制(TFB)功能，在高功率输出、高环境温度、AB类模式低效率等情况下导致芯片内温度较高时，芯片能自动降低系统增益，避免芯片进入过温关断保护模式，在保证音乐品质的前提下显著提升音乐峰值功率。

此外，HT878T内部集成免滤波器调制技术，能够直接驱动扬声器，内置的关断功能使待机电流最小化，还集成了输出端过流保护、片内过温保护和电源欠压异常保护等功能。

TYPICAL APPLICATION

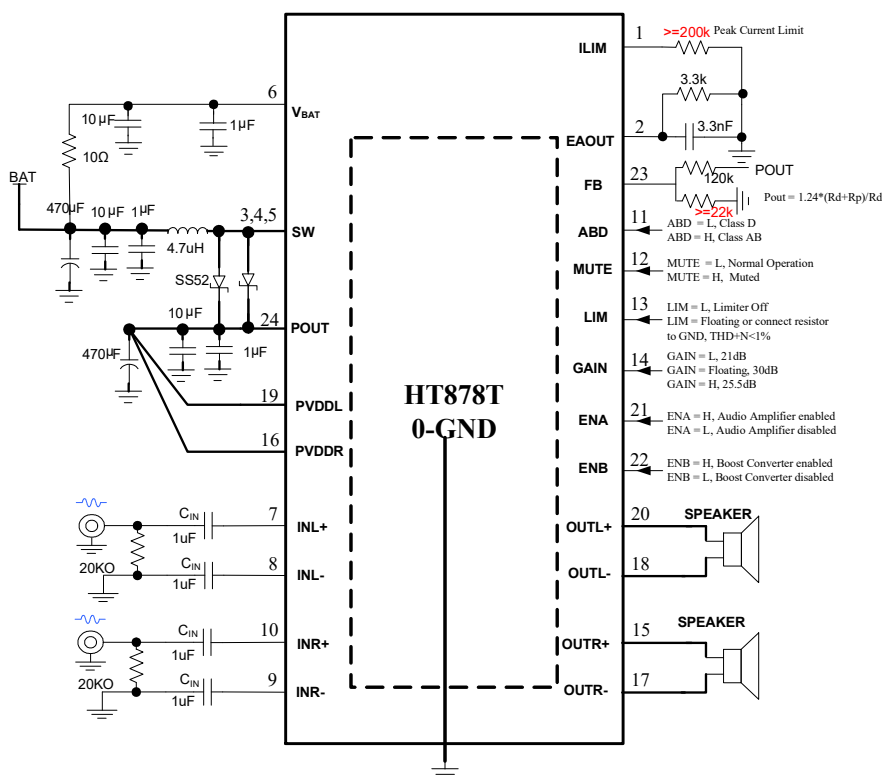

■ TERMINAL CONFIGURATION

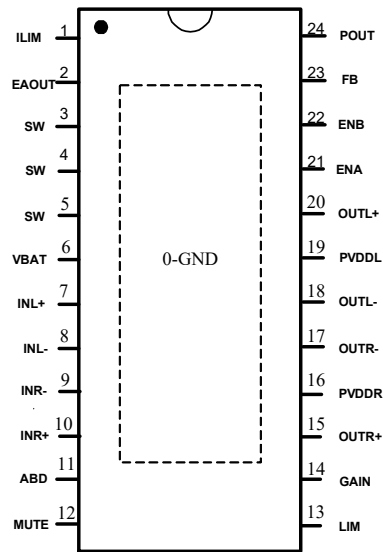

HT878H Top View

■ TERMINAL FUNCTION

Terminal No.	Name	I/O ¹	Description
0	GND	G	Power ground. Also provides thermal connection from the device to the board. A matching ground pad should be provided on the PCB and the device connected to it via solder. 地, 同时提供器件向板级散热的路径。PCB 板上需要留有足够的铺地露铜与之良好焊接。
1	ILIM	I	Adjustable switch peak current limit. An external resistor should be connected between this pin and GND. 最大限流值设置端, 外部接电阻到地。
2	EAOUT	I	Error amplifier output. Connect a 3.3nF capacity paralleled with a 15k resistor to GND typically. 误差放大器输出端。接 3.3nF 并联 15k 电阻到地。
3,4,5	SW	I	Boost and rectifying switch input. 升压整流开关输入端。
6	VBAT	P	Power supply for logic. 内部逻辑电源供电端。
7	INL+	I	Positive input (differential+) for audio amplifier of left channel. 音频左声道输入正端。
8	INL-	I	Negative input (differential-) for audio amplifier of left channel. 音频左声道输入负端。
9	INR-	I	Negative input (differential-) for audio amplifier of right channel. 音频右声道输入负端。
10	INR+	I	Positive input (differential+) for audio amplifier of right channel. 音频右声道输入正端。
11	ABD	I	Audio amplifier mode selection. Class D is selected when it is pulled low; Class AB is selected when it is pulled high. 音频功放模式选择端。接地时为 D 类模式, 接高时为 AB 类模式。
12	MUTE	I	MUTE control set. The audio amplifier is muted when it is pulled high. 静音控制端。接高时, 芯片进入静音模式。
13	LIM	I	Enable the Limiter Function and select limiter level. 使能限幅功能和限幅值设置端。
14	GAIN	I	System GAIN set. Three GAIN level for select. 增益设置端。

¹ I: Input; O: Output; G: Ground; P: Power

15	OUTR+	O	Positive output terminal (BTL+) for right channel. 右声道正端输出。
16	PVDDR	O	Power supply terminal for right channel. 右声道功率电源端。
17	OUTR-	O	Negative output terminal (BTL-) for right channel. 右声道负端输出。
18	OUTL-	O	Negative output terminal (BTL-) for left channel. 左声道负端输出。
19	PVDDL	P	Power supply terminal for left channel. 左声道功率电源端。
20	OUTL+	O	Positive output terminal (BTL+) for left channel. 左声道正端输出。
21	ENA	I	Audio amplifier enabling terminal. Audio amplifier is enabled when it is pulled high. 功放使能端，接高时功放开启。
22	ENB	I	Boost converter enabling terminal. Boost converter is enabled when it is pulled high. 升压使能端，接高时自适应 G 类升压开启。
23	FB	I	Regulator Feedback Input. 升压调节反馈输入端。
24	POUT	I	Boost Converter voltage detect pin. 升压输出检测端。

SPECIFICATIONS¹
Absolute Maximum Ratings²

PARAMETER	Symbol	MIN	MAX	UNIT
Supply voltage range	V _{BAT}	-0.3	5.5	V
Input voltage range	V _{IN}	-0.3	V _{BAT}	V
Output voltage range	V _{POUT}	-0.3	9.0	V
Operating temperature range	T _A	-40	85	°C
Operating junction temperature range	T _J	-40	170	°C
Storage temperature range	T _{STG}	-50	170	°C

Recommended Operating Condition

PARAMETER	Symbol	CONDITION	MIN	TYP	MAX	UNIT
V _{BAT} supply voltage range	V _{BAT}		2.8	3.7	5.5	V
Output voltage range	V _{POUT}		V _{BAT} -0.2		8.5	V
High-level input voltage	V _{IH}		1.5		V _{BAT}	V
Low-level input voltage	V _{IL}				0.7	V
Operating temperature	T _a		-40	25	85	°C
Load impedance	R _L			4		Ω

Electrical Characteristics

Condition: T_a=25°C, V_{BAT} = 3.7V, f_{IN} = 1 kHz, V_{POUT} = 8.3V, Gain = 25.5dB (GAIN=H), C_{IN} = 1uF, Limiter Function disabled (LIM=GND), R_{LIM} = 470k, C_{EAOUT}=3.3nF // 15k, Load = 4ohm + 22uH, unless otherwise specified.

Main Characteristics

PARAMETER	Symbol	CONDITION	MIN	TYP	MAX	UNIT
V _{BAT} supply voltage range	V _{BAT}	Boost + Amp work	2.8	3.6	5.5	V
Boost on threshold voltage	V _{B_TH}	Amplifier Output V _{RMS}		1.6		V
Start-up time	t _{ON}	t _{BOOST_ON} , Boost only		50		ms
		t _{AMP_ON} , Audio Amplifier only		60		
Closed-loop voltage gain	A _v	GAIN=L		21		dB
		GAIN=H		25.5		
		GAIN Floating		30		
Internal Input impedance (per input pin)	R _{IN}	GAIN=L		36		KΩ
		GAIN=H		24		
		GAIN Floating		15.4		

Boost Converter

PARAMETER	Symbol	CONDITION	MIN	TYP	MAX	UNIT
Reference voltage at the FB pin	V _{REF}			1.24		V
Boost off delay time	t _{BOOST_OFF}			160		ms
Boost converter input current limit	I _L	C _{EAOUT} = 3.3nF//3.3k R _{LIM} = 200k		7		A
Reference voltage at I _{LIM} pin	V _{ILIM}			1.24		V
Boost converter frequency	f _{BOOST}	ENA = H		f _{Class-D}		KHz

¹ Depending on parts and PCB layout, characteristics may be changed.

² Stresses beyond those listed under absolute maximum ratings may cause permanent damage to the device. These are stress ratings only, and functional operation of the device at these or any other conditions beyond those indicated under recommended operating conditions is not implied. Exposure to absolute-maximum-rated conditions for extended periods may affect device reliability

Boost Converter + Class D (BTL)

PARAMETER	Symbol	CONDITION		MIN	TYP	MAX	UNIT
Output power	P _O	THD+N=1%	V _{BAT} = 4.2V Load = 4ohm + 22uH, POUT = 8.3V		2×6.8		W
		THD+N=10%			2×8.4		
		THD+N=1%	V _{BAT} = 4.2V Load = 4ohm + 22uH, POUT = 7.5V		2×5.7		
		THD+N=10%			2×7.0		
Total harmonic distortion plus noise	THD+N	P _O =0.25W	R _L =4Ω+22uH, f=1kHz		0.04		%
		P _O =1.0W			0.04		
Noise output voltage	V _N	f=20Hz~20kHz, A-weighted, Av=21dB			125		μV _{rms}
Signal to noise ratio	SNR	1W, f=20Hz~20kHz, A-weighted, Av=21dB			84		dB
Efficiency (Class D + Boost)	η	V _{BAT} = 3.7V, R _L = 4Ω+22uH, P _O = 2×0.5W			80		%
		V _{BAT} = 3.7V, R _L = 4Ω+22uH, P _O = 2×1W			75		
		V _{BAT} = 4.2V, R _L =4Ω+22uH, P _O = 2×5.0W			78		
Operating quiescent current	I _{BAT}	Input Grounded, With or without load			7		mA
Shutdown quiescent current	I _{SD}	Input Grounded, With or without load				1	μA
Class D switching frequency	f _{Class-D}				470		kHz

Class AB Only (BTL)

PARAMETER	Symbol	CONDITION		MIN	TYP	MAX	UNIT
Output power	P _O	V _{BAT} = 4.2V	THD+N=1% Load = 4ohm + 22uH		2*1.59		W
		V _{BAT} = 3.7V			2*1.17		
		V _{BAT} = 3.3V			2*0.92		
		V _{BAT} = 4.2V	THD+N=10% Load = 4ohm + 22uH		2*1.98		
		V _{BAT} = 3.7V			2*1.47		
		V _{BAT} = 3.3V			2*1.16		
Total harmonic distortion plus noise	THD+N	P _O =1W	V _{BAT} =4.2V, f=1kHz, R _L =4Ω+22uH		0.11		%
Noise output voltage	V _N	f=20Hz~20kHz, A-weighted, Av=21dB			125		μV _{rms}
Efficiency	η	V _{BAT} = 3.7V, R _L = 4Ω+22uH, P _O = 2×1W			65		%
Operating quiescent current	I _{BAT}	Input Grounded, With or without load			8		mA
Shutdown quiescent current	I _{SD}	Input Grounded, With or without load				1	μA

Other Characteristics

PARAMETER	Symbol	CONDITION	MIN	TYP	MAX	UNIT
Limiter Function						
Gain range	$A_{V_{LIM}}$			30		dB
Gain step	STP_{LIM}			120		/
Attack time	t_{A_LIM}			10		ms/dB
Release time	t_{R_LIM}			160		ms/dB
Limiter level (Peak)	V_{LIM_L}	LIM floating		$0.8 \times V_{POUT}$		V
Thermal Foldback (TFB)						
Over temperature protection point	OTP			150		°C
Over temperature protection hysteresis	OTP_{hys}			30		°C
Over temperature protection recovery point	OTPR			140		°C
Thermal foldback trig point	TFB			130		°C
TFB attack time	t_{A_TFB}			640		ms/dB
TFB release time	t_{R_TFB}			1280		ms/dB
Input/output						
Internal pulldown resistor of ENA, ENB, ABD, MUTE	R_{DOWN}			300		kΩ
High-level input voltage ENA, ENB, BST, ABD, MUTE, GAIN	V_{IH}		1.5			V
Low level input voltage of ENA, ENB, BST, ABD, MUTE, GAIN	V_{IL}				0.4	V

■ TYPICAL OPERATING CHARACTERISTICS

Condition: $V_{BAT} = 4.2V$, $f_{IN} = 1kHz$, Gain = 25.5dB, $C_{IN} = 1\mu F$, unless otherwise specified.

Limiter

Characteristics below are measured in Class D mode.

Condition: $V_{BAT} = 4.2V$, $f_{IN} = 1kHz$, Gain = 25.5dB, $C_{IN} = 1\mu F$, Limiter ON, Output = Load + Filter, Load = 4ohm, Filter = 100ohm + 47nF, unless otherwise specified.

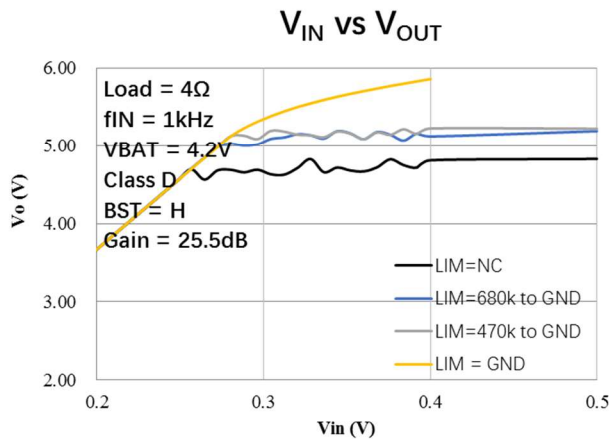
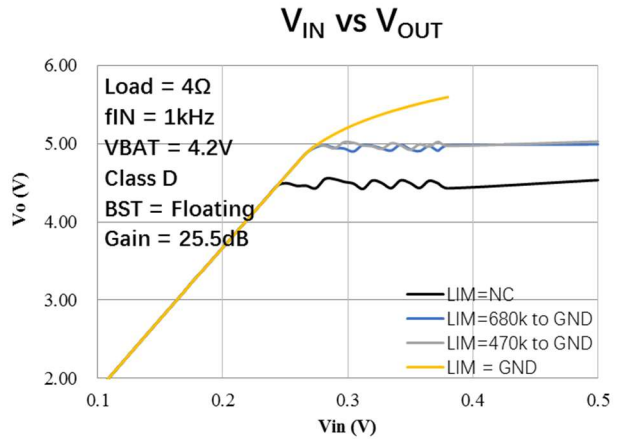
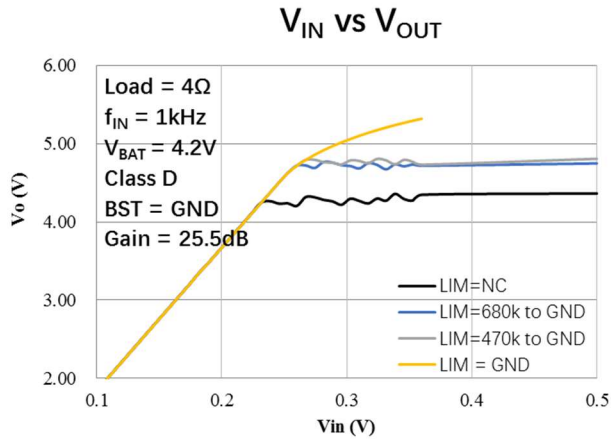

BOOST + Class D (BTL)

Condition: $V_{BAT} = 4.2V$, $f_{IN} = 1kHz$, Gain = 25.5dB, $C_{IN} = 1\mu F$, Limiter off, Output = Load + Filter, Load = 4ohm, Filter = 100ohm + 47nF, unless otherwise specified.

V_{BAT} vs I_{BAT}

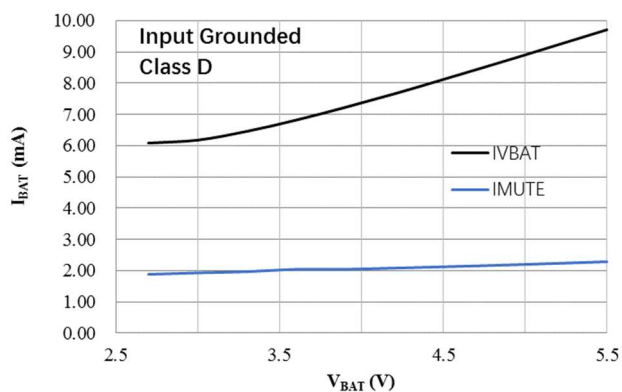

f_{IN} vs Gain

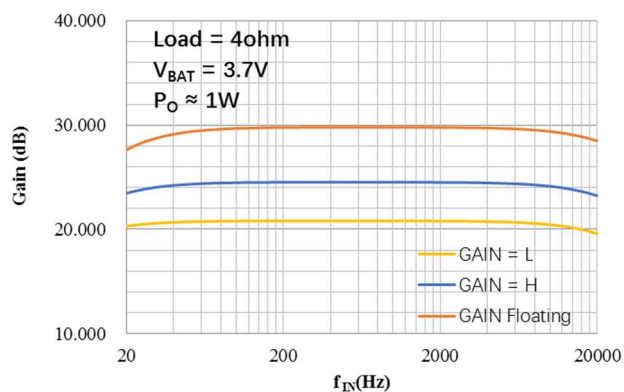

P_o vs THD+N

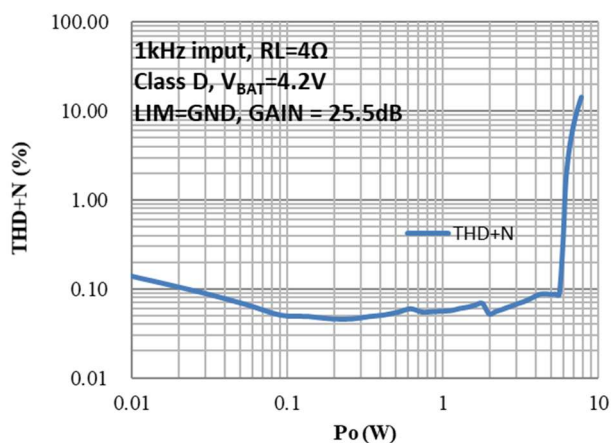

f_{IN} vs THD+N

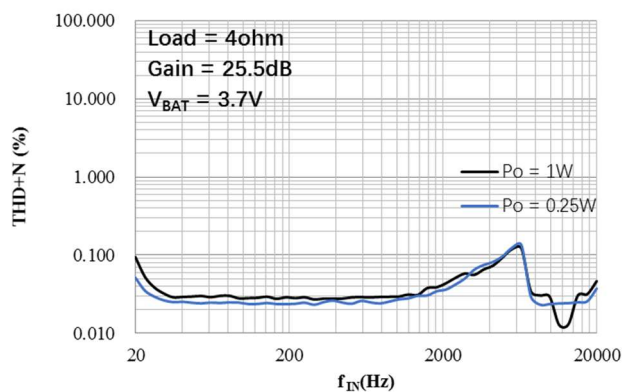

V_{BAT} vs P_o

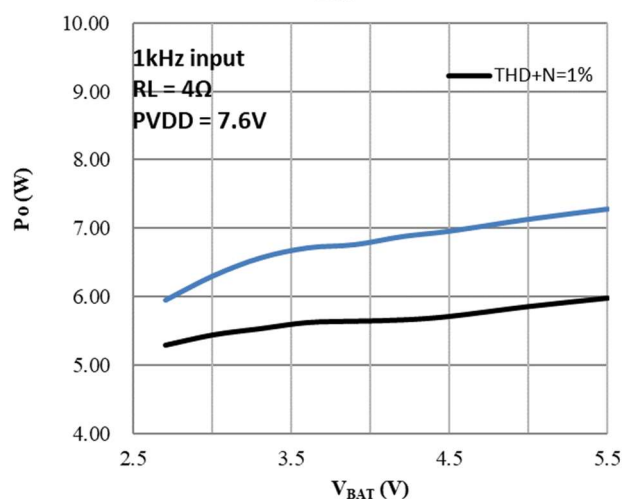

V_{BAT} vs P_o

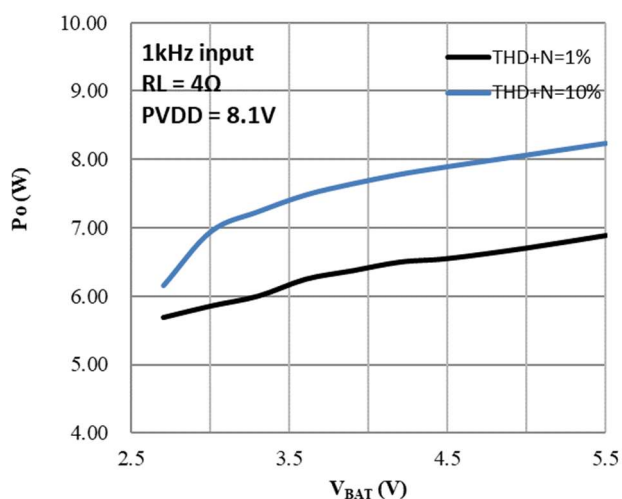

Po vs η

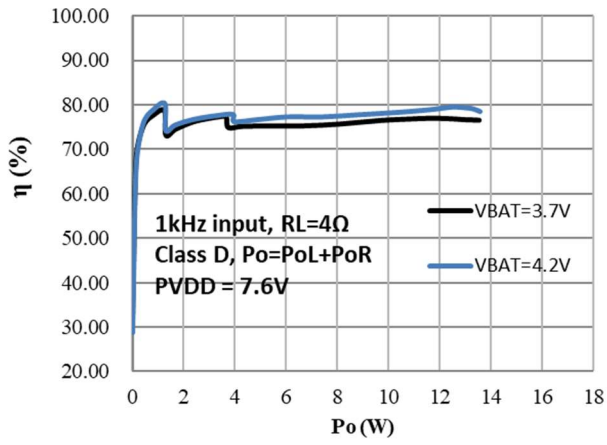

Po vs η

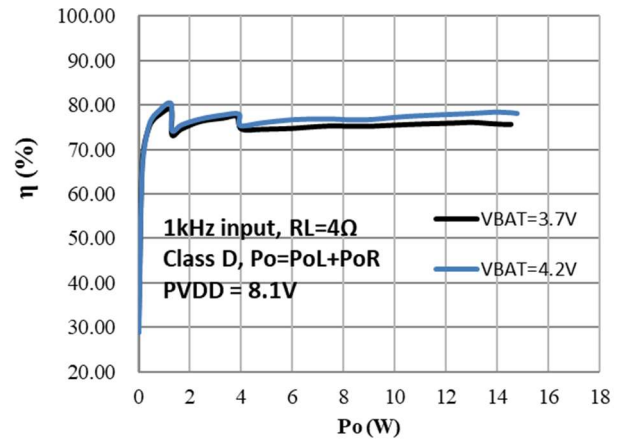

Class AB Only (BTL)

Condition: $V_{BAT} = 4.2V$, $f_{IN} = 1kHz$, Gain = 25dB, $C_{IN} = 1\mu F$, Battery tracking disabled (Point off), Output = Load = 4ohm + 22uH, unless otherwise specified.

V_{BAT} vs I_{BAT}

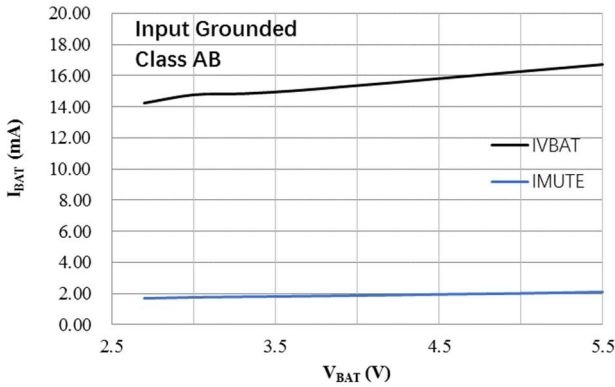

V_{BAT} vs P_o

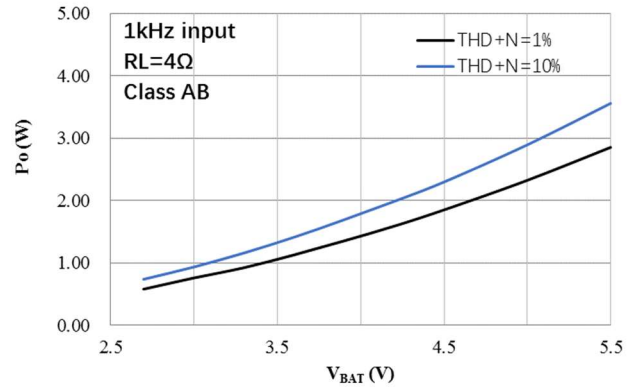

P_o vs η

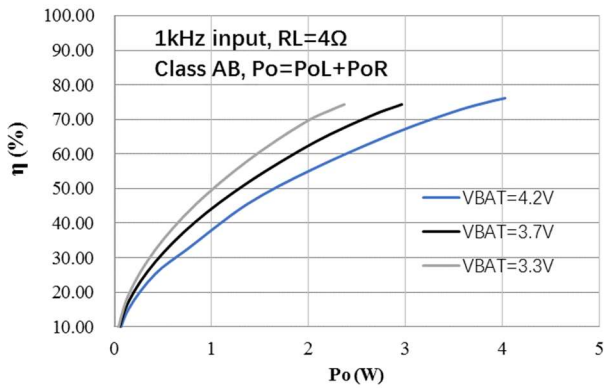

f_{IN} vs THD+N

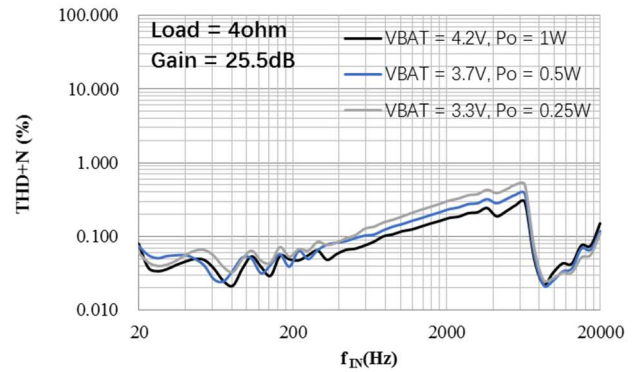

P_o vs THD+N

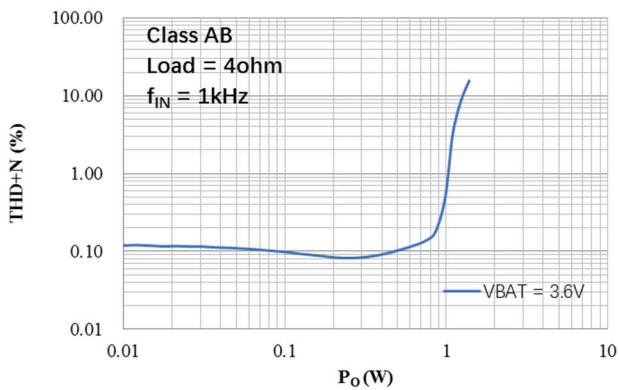

f_{IN} vs Gain

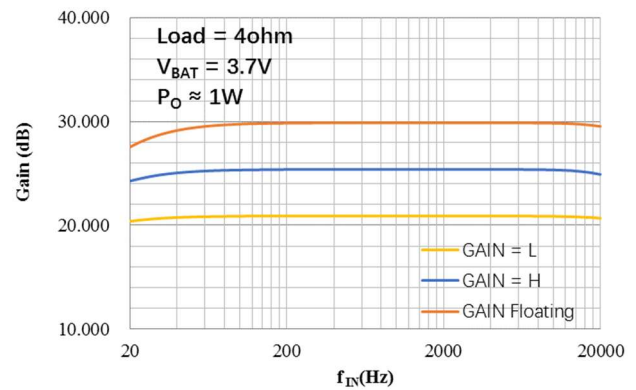

APPLICATION INFORMATION

1. Glossary

The application section may use the following terms.

Limiter: When Limiter function is active, the output music can be limited below the Limiter Level.

Limiter Level: V_{LIM_L} for short. The maximum output voltage allowed before amplifier gain is automatically reduced.

Thermal Foldback: TFB for short. When this function is active, HT878(T) reduces the on-die power dissipation by reducing system gain if the on-die temperature exceeds the Thermal Foldback Trig Point in case of the device being operated beyond the recommended temperature or power limit, or with a weaker thermal system than recommended. Once the die temperature drops below the TFB trig point, the system gain is increased until the TFB trig point is reached.

Thermal Foldback Trig Point: TFB for short. The on-die temperature trig point for reducing system gain.

Attack Time: t_A for short. The rate of Limiter or TFB gain decrease. The default value for Limiter Attack Time is 10ms/dB, and the default value of TFB Attack Time is 640ms/dB.

Release Time: t_R for short. The rate of Limiter or TFB gain increase. The default value for Limiter release time is 160ms/dB, and the default value for TFB Release Time is 1280ms/dB.

Adaptive Class G Boost Converter: Only when the output audio signal exceeds a preset voltage threshold (Boost on Threshold Voltage V_{B_TH}), the boost converter is enabled. When the audio output voltage is lower than the threshold voltage, the boost deactivates automatically. This technology can improve the system efficiency and extend play time in battery applications.

Boost on Threshold Voltage: V_{B_TH} for short. The output audio signal voltage threshold for enabling boost converter.

2. Feature Description

2.1 Limiter Function (LIM pin)

The Limiter Function can protect speakers, improve loudness, smooth the music, limit peak supply current, extend battery life, and prevent early shutdown at end-of-charge battery voltages.

When Limiter function activates, the output music can be limited below the Limiter Level (V_{LIM_L}). If the output audio signal exceeds the Limiter Level, HT878T decreases amplifier gain by the rate of attack time (10ms/dB), 0.25dB per step. HT878T increases the gain by the rate of release time (160ms/dB), 0.25 per step, once the output audio is below the limiter level. Fig. 1 shows this relationship.

本规格书可能用到以下词汇。

限幅: 当限幅功能开启, 功放输出被限制在限幅值以下。功放输出达到限幅值后, 芯片将自动降低增益以维持输出不超过限幅值。

限幅值: 限幅功能开启后设置的最大输出电压, 简称 V_{LIM_L} 。

自动限温控制: 简称 TFB。当芯片由于较高的环境温度、较高的持续功率、较差的 PCB 散热等原因导致内部结温达到触发点时, 该功能可自动通过降低功放增益以降低芯片内部结温, 直至芯片内部结温降至触发点, 该功能将再次增加功放增益。

自动限温控制触发点: 简称 TFB, 即自动限温控制功能下因芯片内部结温升高而降低功放增益的触发温度。

启动时间: 限幅功能和自动限温控制功能的增益降低速率。限幅功能的启动时间为 10ms/dB, 自动限温控制功能的启动时间为 640ms/dB。

释放时间: 限幅功能和自动限温控制功能的增益增加速率。限幅功能的释放时间为 160ms/dB, 自动限温控制功能的释放时间为 1280ms/dB。

自适应 G 类升压: 仅当功放输出幅度达到预设值 (称为升压阈值, V_{B_TH}), 升压开启。当功放输出幅度低于升压阈值, 升压关闭。此功能可有效提升整体效率、延长电池的播放时间。

升压阈值: 简称 V_{B_TH} 。开启升压功能的功放输出阈值。

限幅功能可能提供自动增益调节以调节声音大小, 使音乐更悦耳, 防止喇叭损坏, 增加电池续航时间, 降低电池低电量时被拉死的风险。

该功能开启后, 当功放输出电压达到限幅值, 功放增益将以每步 0.25dB、 $t_A = 10\text{ms/dB}$ 的速率自动降低, 使功放输出维持在限幅值。随后, 如果过功放输出电压小于限幅值, 功放增益将以每步 0.25dB、 $t_R = 160\text{ms/dB}$ 的速率自动增加。该过程示意图如下。

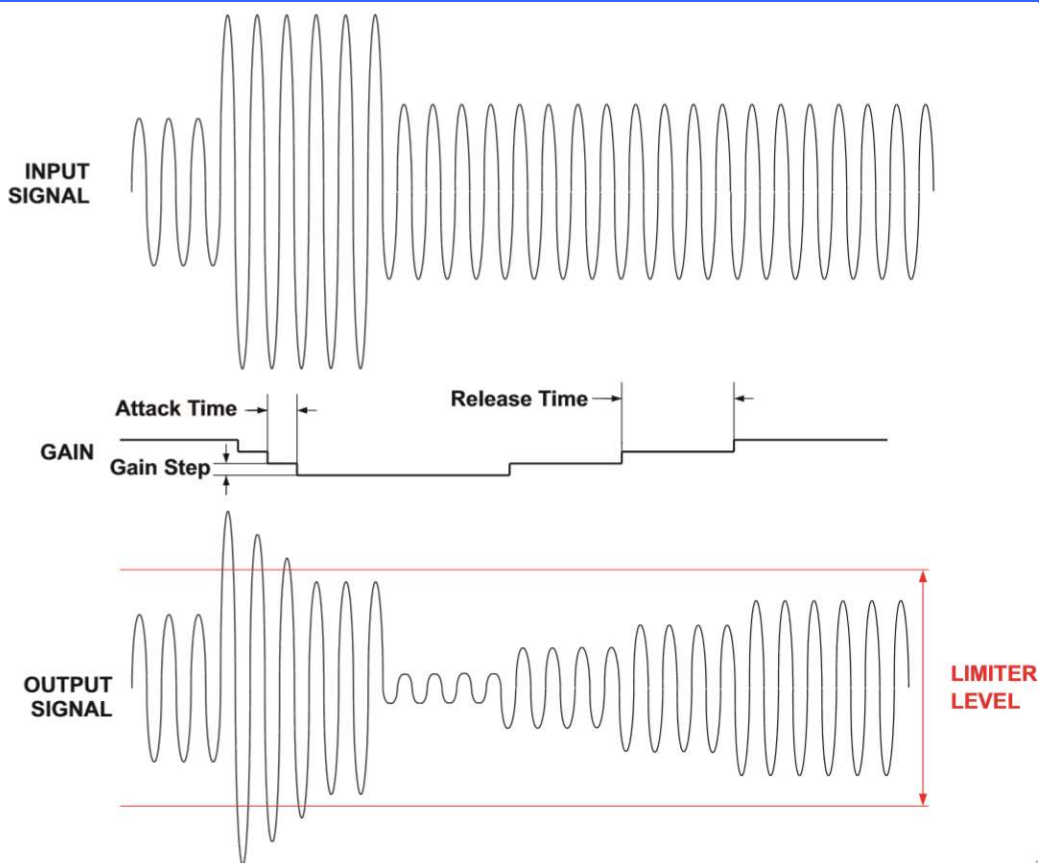

Figure 1 Limiter Function

The Limiter Level can be modified through LIM terminal. If the LIM terminal is directly grounded, Limter function is disabled. When the LIM terminal is floating the output power can be limited under $THD+N \approx 1\%$. To get a larger power, connect a resistor to Ground, a resistor with smaller resistance will get a larger power.

其中，限幅值可通过LIM引脚设置。LIM脚短接接地时，限幅功能关闭。LIM脚悬空时，功放的输出功率可被限制在 $THD+N \approx 1\%$ 以下。若需要更大的输出功率，LIM脚接一个电阻到地，该电阻越小，输出功率越大；若需要更小的输出功率，LIM脚接一个电阻到VABT脚，电阻越小，功率越小。

2.2 Adaptive Class G Boost Converter

The HT878T consists of an adaptive boost converter and an audio amplifier. The boost converter takes the supply voltage, VBAT, and increases it to a higher output voltage, POUT. POUT drives the supply voltage of the audio amplifier, PVDDx. This improves loudness over non-boosted solutions. An external inductor and diode should be added for the boost converter.

HT878T 包含一个自适应升压和一个功放。其中自适应升压电路将输入的电池电压 VBAT 升压至更高的电压 POUT，以提供给功放电源 PVDDx。该方法可提升功放的输出功率。该自适应升压需要外部放置电感和二极管。

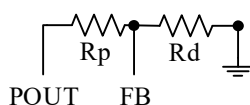

Figure 2 FB Terminal Configuration

The boost output voltage POUT is set by a resistive voltage divider from the output voltage POUT to FB terminal, which is shown in Figure 2. The output voltage can be calculated by $POUT = 1.24 \cdot (R_p + R_d) / R_d$. Some typical output voltages can be set by following settings. **Set a output voltage no larger than 8.0V.**

升压的输出电压可通过FB端电阻设置，如上图2， $POUT = 1.24 \cdot (R_p + R_d) / R_d$ 。相关典型输出电压设置如下表。升压值设置应不超过8V。

Table. 1 Output Voltage Setting for HT878H

POUT	Rp(ohm)	Rd(ohm)
≈6.0V	120k	31k
≈6.8V	120k	27k
≈7.4V	120k	24k
≈8.0V	120k	22k

The Class G boost converter is adaptive and supports only boost on-off. It activates automatically depending on the output audio signal amplitude. When the output audio signal exceeds a preset voltage threshold (Boost on Threshold Voltage V_{B_TH}), the boost converter is enabled, and the voltage at POUT is the preset voltage. When the audio output voltage is lower than the threshold voltage, the boost deactivates automatically. The Boost on Threshold Voltage V_{B_TH} is fixed as 1.6V. Fig. 3 shows how the adaptive boost modulates with a typical audio signal. By automatically deactivating the boost converter and passing VBAT to POUT, the HT878T efficiency is improved at low output power and extend the play time in battery applications.

HT878T集成的同步升压模块还具有自适应功能，即只有当输出信号大于升压阈值 V_{B_TH} 时，HT878T才会进入升压模式，该功能能增加系统整体效率，在播放音乐时大大提高锂电池续航时间。

下图显示的是播放音乐时，输出信号和VPOUT的变化关系。

该升压模块可通过ENB引脚开启或关闭。高电平为升压开启，ENB低电平为升压关闭。

The boost converter can be enabled or disabled by terminal ENB. When ENB is pulled low, the boost converter is disabled; when ENB is pulled high, the boost converter is enabled.

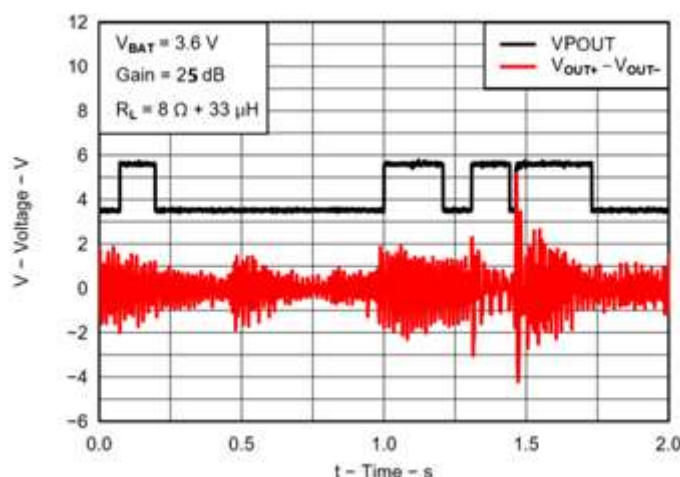

Figure 3 Adaptive Boost Converter with Typical Music Playback

2.2.1 Component Selection

(1) BOOST Converter Input and Output Capacitor C_{IN} , C_{OUT}

For the capacitor maintaining the supply voltage, the value of the boost capacitor is determined by the minimum value of working capacitance required for stability and the maximum voltage ripple allowed on PVDD in the application. It acts as a charge reservoir, providing energy faster than the board

supply, thus helping to prevent any droop in the supply voltage.

For the decoupling capacitor, a low equivalent-series-resistance (ESR) ceramic capacitor is

needed. This choice of capacitor and placement helps with higher frequency transients, spikes, or digital hash on the line. Additionally, placing this decoupling capacitor close to the HT878(T) is important, as any parasitic resistance or inductance between the device and the capacitor causes efficiency loss.

Over all, 1uF//10uF//470uF (paralleled) is highly recommended to be placed in both input and output terminal as closely to the pin as possible.

对于储能电容，电容值由应用中稳定所需的最小工作电容值和PVDD上允许的最大电压纹波决定。较大的储能电容有助于防止电源电压下降。

(2) Inductor Selection and Placement

Inductor current rating is determined by the requirements of the load. The inductance is determined by two factors: the minimum value required for stability and the maximum ripple current permitted in the application. $L \geq 4.7\mu\text{H}$, $\text{DCR} < 0.5\text{ohm}$ is recommended for general application circuit. The inductor should be placed as close to the SW pin as possible with direct and wide traces. For different applications of output power, the requirement of saturation current (I_{SAT}) of the inductor is different, recommendations are as follows.

对于滤波电容器，低等效串联电阻(ESR)的陶瓷电容器较为合适。这种电容的选择和布局有助于提高线路上的瞬态尖峰和噪声。此外，将这种滤波电容靠近HT878T非常重要，因为芯片和电容之间的任何寄生电阻或电感都会导致效率损失。

我们建议，在VBAT和POUT端至少放置一组1uF和10uF滤波电容到地，用于吸收纹波和稳定电压，并尽可能靠近芯片引脚。另外，VBAT和POUT端需各放置一个不小于470uF的储能电容。这些电容应以最短的路径连接至安静可靠的地，以有效滤波。

电感的电流参数由功放的最大功率决定；而电感的感值则由可允许的最大峰值电流决定。通常而言，为保证芯片的正常工作，建议使用 $L \geq 4.7\mu\text{H}$, $\text{DCR} < 0.5\text{ohm}$ 。

电感需要尽可能靠近SW引脚，并且与SW在同一PCB层尽可能短的直接相连。

对于不同的功率应用，电感的建议饱和电流如下表。

Table. 2 the Recommendations of I_{SAT} of inductor and Diode for Different Applications

Output Power (W)	I_{SAT} (A)	Diode
2×4	>3.5	SS52
2×5	>4.5	SS52
2×6	>5.5	SS52//SS52
2×7	>6.5	SS52//SS52
2×8	>7.5	SS52//SS52

(3) Schottky Diode Selection and Placement

A Schottky Diode with $V_{\text{RRM}} > 12\text{V}$, $V_{\text{FM}} < 0.5\text{V}$ and high I_{F} is recommended for general application circuit. The diode should be placed as close to the SW and PVDDx pin as possible with direct and wide traces. For different applications of output power, the recommendations of the diode are listed in Table 3.

肖特基二极管的建议参数： $V_{\text{RRM}} > 12\text{V}$, $V_{\text{FM}} < 0.5\text{V}$ ，并依据不同功率选择不同 I_{F} 。典型应用如上表3。该肖特基二极管应尽可能靠近电感和PVDDx放置。

(4) Layout Considerations

The power traces, consisting of the GND, SW, VBAT, and PVDD should be kept short, direct, wide, and be placed as closely to the pin as possible. The switching mode SW should be paid more attention for EMI and reliability consideration.

电源线 (V_{BAT} , PVDD, 包括地回路), SW线, 应尽可能使用短、粗、无弯折、无过孔的引线连接; 应特别注意SW端引线, 其开关频率会影响EMI;

Place C_{IN} and C_{OUT} near VBAT and Diode as closely as possible to maintain voltage steady and filter out the pulsing current.

V_{BAT} 和 V_{POUT} 端 C_{IN} , C_{OUT} 应尽可能靠近芯片引脚, 以保证电压的稳定;

The GND of the HT878T, C_{IN} and C_{OUT} should be connected close together directly to ground plane.

芯片地、 C_{IN} 和 C_{OUT} 的地, 应尽可能以最短的路径连接至稳定可靠的地。

2.3 Thermal Foldback (TFB)

The HT878T Thermal Foldback, TFB, is designed to protect the HT878T from excessive die temperature in case of the device being operated beyond the recommended temperature or power limit, or with a weaker thermal system than recommended. The TFB works by reducing the on-die power dissipation by reducing the HT878T system gain by the rate of attack time (640ms/dB) in steps of 0.25dB if the TFB trig point (default value 130°C) is exceeded. Once the die temperature drops below the TFB trig point, the HT878T gain is increased by a single or by the rate of release time (1280ms/dB) in steps of 0.25dB until the TFB trig point, or a maximum of 30dB attenuation is reached, and the system gain will be decreased again, or the system gain is at its nominal gain level. The procedure shows as follows.

HT878T 内部集成了自动限温控制功能, 当芯片因环境温度过高、功放过载、系统散热性能不佳等原因引起结温高于自动限温控制触发点 (TFB, 130°C) 时, 功放将以 $t_A = 640\text{ms/dB}$ 的速率自动减小增益, 以减小芯片功率耗散从而降低结温; 随着温度的降低, 当结温小于过温限幅点 TFB 时, 功放又将以默认值 $t_R = 1280\text{ms/dB}$ 的速率自动增加增益, 直到结温到达过温限幅点 (TFB)。如此循环。增加或减小的每步增益为 0.25dB。该过程示意图如下。

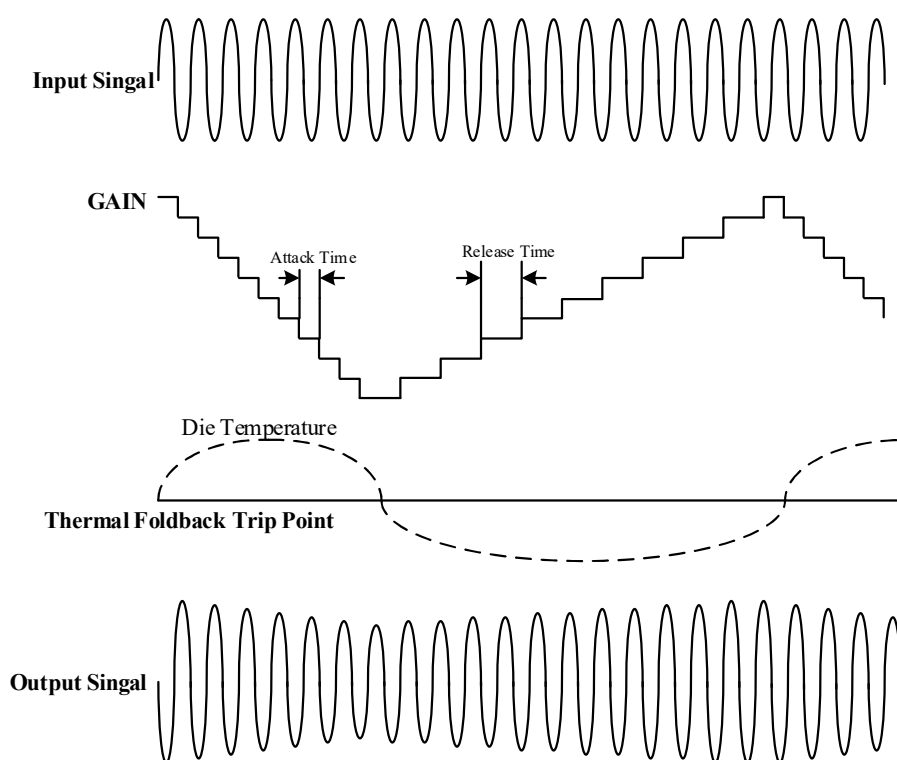

Figure 4 Thermal Foldback Operation

2.4 Audio Amplifier Input Configuration

HT878T integrates an amplifier (can work in either class D or Class AB mode) with analog input (single-ended or differential), that can directly drive a speaker. For a differential operation, input signals into IN+ and IN- pins via DC-cut capacitors (C_{IN}) and external input resistors R_{IN} . The input signal gain is calculated by

$$\text{Gain} \approx 12\text{dB} + 20 \times \log\left(\frac{R_F}{\text{External } R_{IN} + \text{Internal } R_{IN}}\right).$$

And the high pass cut-off frequency of input signal can be calculated by $f_c = \frac{1}{2\pi(\text{External } R_{IN} + \text{Internal } R_{IN}) \times C_{IN}}$.

For a single-ended operation, input signals to IN+ pin via a DC-cut capacitor (C_{IN}) and external input resistor (R_{IN}). IN- pin should be connected to ground via a DC-cut capacitor and external input resistor (R_{IN}) (with the same value of C_{IN} and R_{IN}). The Gain and high pass Cut-off frequency are the same as the above case.

The values of internal R_{IN} and R_F is shown in Table. 4.

HT878T 内部集成了音频功放(可工作在 D 类或 AB 类模式), 可接收差分或单端的模拟输入音频信号, 并可直接驱动喇叭。

对差分输入, 通过隔直电容 C_{IN} 和外部输入电阻 R_{IN} 分别输入到 IN+ 和 IN- 端。此时功放系统增益为

$$\text{Gain} \approx 12\text{dB} + 20 \times \log\left(\frac{R_F}{\text{External } R_{IN} + \text{Internal } R_{IN}}\right)$$

输入 RC 高通滤波器的截止频率为

$$f_c = \frac{1}{2\pi(\text{External } R_{IN} + \text{Internal } R_{IN}) \times C_{IN}}.$$

对单端输入, 则通过 C_{IN} 和外部输入电阻 R_{IN} 耦合到 IN+ 端。IN- 端必须通过相同的 C_{IN} 和 R_{IN} 接地。截止频率 f_c 与差分输入时相同。

其中, 输入电阻与功放增益的关系如下表。

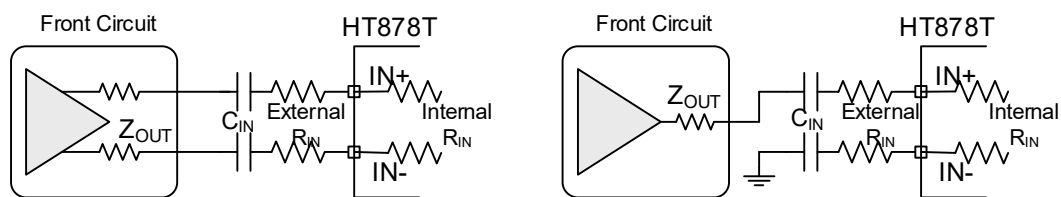

Figure 5 (1) Differential Input;

(2) Single-ended Input

Table. 3 Internal input resistors and feedback resistors

GAIN	Internal R_{IN} (ohm)	R_F (ohm)
21dB	36k	102k
25.5dB	24k	114k
30dB	15.4k	122.8k

2.5 Amplifier Output

Generally, a speaker can be directly line to the output terminal of the amplifier as load. But Once HT878T works in Class D mode, the cable lined to the speaker is very long, and EMI is concerned, ferrite beads or L-C filter is recommended.

2.6 Protection Function

HT878T has the protection functions such as Over-Current Protection function, Thermal Protection function, and Low Voltage Malfunction Prevention function.

一般而言, 输出端可直接连接负载喇叭。如果输出端的输出线较长, 或者对 EMI 的要求较高, 则可选择添置铁氧体磁珠或 LC 滤波器。

HT878T 具有以下几种保护功能: 输出端过流保护、片内过温保护、电源欠压异常保护。

(1) Over-current Protection function

When a short circuit occurs between one output terminal and Ground, or the other output, the over-current protection mode starts up. In the over current protection mode, the differential output terminal becomes a high impedance state. Once the short circuit conditions are eliminated, the over current protection mode can be cancelled automatically. It's only available in Class D mode.

当检测到一输出端对地、或对另一输出端短路时，过流保护启动，输出端切换至高阻态，防止芯片烧毁损坏。短路情况消除后，芯片自动退出保护模式。该保护电路仅对Class D有效。

(2) Thermal Protection function

When excessive high temperature of HT878T (OTP) is detected, the thermal protection mode starts up. In the thermal protection mode, the differential output terminal becomes Weak Low state (a state grounded through high impedance).

当检测到芯片内温度超过 OTP 时，过温保护启动，正负输出端切换至弱低电平状态（内部通过高阻接地），防止芯片被热击穿损坏。

(3) Low voltage Malfunction Prevention function

This is the function to establish the low voltage protection mode when VBAT terminal voltage becomes lower than the detection voltage (VUVLL) for the low voltage malfunction prevention. And the protection mode is canceled when VBAT terminal voltage becomes higher than the threshold voltage (VUVLH). In the low voltage protection mode, the differential output pin becomes Weak Low state (a state grounded through high impedance). HT878T will start up within the start-up time when the low voltage protection mode is cancelled.

当检测到电源端 V_{BAT} 低于 V_{UVLL} ，启动欠压保护，D 类功放输出端为弱低电平状态（内部通过高阻接地）；当检测到 V_{BAT} 高于 V_{UVLH} ，保护模式自动解除，经启动时间 T_{STUP} 后进入正常工作状态。

3. Other Terminal Configurations

3.1 ENA, ENB

By pulling ENA, ENB terminal into logic low or high, HT878T can enter into different modes, shown as follows.

将 ENA 和 ENB 拉高或拉低，HT878T 可进入不同的工作模式，如下表所示。

Note that an internal 300kohm pulldown resistor is connected to ENA, ENB respectively

ENA 和 ENB 内部均有 300k 到地的下拉电阻。

Table. 4 ENA, ENB Terminal Configuration

ENA	ENB	Mode
H	H	Adaptive Boost + Audio Amplifier
H	L	Audio Amplifier On, Boost disabled
L	H	Boost On, Audio Amplifier disabled
L	L	Shutdown

3.2 Adjustable Peak Current Limit (ILIM pin)

To avoid an accidental large peak current, an internal cycle-by-cycle current limit is adopted. The low-side switch is turned off immediately as soon as the switch current touches the limit (I_{LIM}). The peak switch current limit can be set by a resistor (R_{LIM}) at the ILIM pin to ground. Typical applications are as follows. **Use a resistor no smaller than 200kohm for R_{LIM} .**

在 ILIM 脚外接电阻到地，可设置升压的输入最大峰值电流。典型设置如下表。 **R_{LIM} 取值不应低于 200kohm.**

Table. 5 Typical R_{ILIM} Values

R_{ILIM} (ohm)	I_{LIM} (RMS)
470k	5A
330k	6A
200k	7A

3.3 *ABD Terminal Mode Control (ABD pin)*

When ABD terminal is pulled logic high, HT878T works in Class AB mode.

When ABD terminal is pulled logic low, HT878T works in Class D mode.

Notice that a pull-down resistor from ABD pin to GND is placed inside the chip, the resistor value is about 300kohm..

当 ABD 引脚拉高, HT878T 功放工作在 AB 类模式; 当 ABD 引脚拉低, HT878T 功放工作在 D 类模式。ABD 引脚内部有 300k 到地的下拉电阻。

3.4 *Mute Mode Select (MUTE pin)*

When MUTE terminal is pulled logic high, HT878T works in mute mode, in which the differential output signal becomes Weak Low state (a state grounded through high resistivity).

When MUTE terminal is pulled logic low, HT878T returns to the normal working state.

Notice that a pull-down resistor from MUTE pin to GND is placed inside the chip, the resistor value is about 300kohm.

当 MUTE 引脚拉高, HT878T 功放处于静音模式, 输出高阻下拉到地; 当 MUTE 引脚拉低, HT878T 功放回复正常工作状态。MUTE 引脚内部有 300k 到地的下拉电阻。

3.5 *Gain Select (GAIN pin)*

The GAIN pin is the terminal to select system gain. There are three different choices as following.

GAIN 脚可选择 HT878T 功放的系统增益。设置如下表。

Table. 6 GAIN Terminal Configuration

GAIN	Terminal GAIN	Internal R_{IN} (kohm)
21dB	Logic Low	36k
25.5dB	Logic High	24k
30dB	Floating	15.4k

3.6 *EAOUT*

The HT878T requires external compensation for the stability of boost converter. The EAOUT pin is the output of the internal error amplifier. An external ceramic capacitors C_C and resistor R_C is connected from the EAOUT pin to GND. To be simplified, C_C is 3.3nF and R_C is 3.3kohm which can be adopted in most cases.

HT878T 升压需要外部补偿电路以维持升压稳定性。EAOUT 外部需要接电阻并联电容到地。典型的, EAOUT 可接 3.3nF 并联 3.3kohm 电阻到地。

3.7 *PVDDL and PVDDR*

PVDDL and PVDDR are the power supply terminals for audio output driving of channel L and channel respectively. They should be connected directly to the bulk capacitor C_{OUT} of the boost converter closely with wide routing.

PVDDL和PVDDR是功放功率供电端(左声道和右声道)。其需要以尽可能短的路线连接至升压输出的大电容。

4. Typical Circuit Diagram

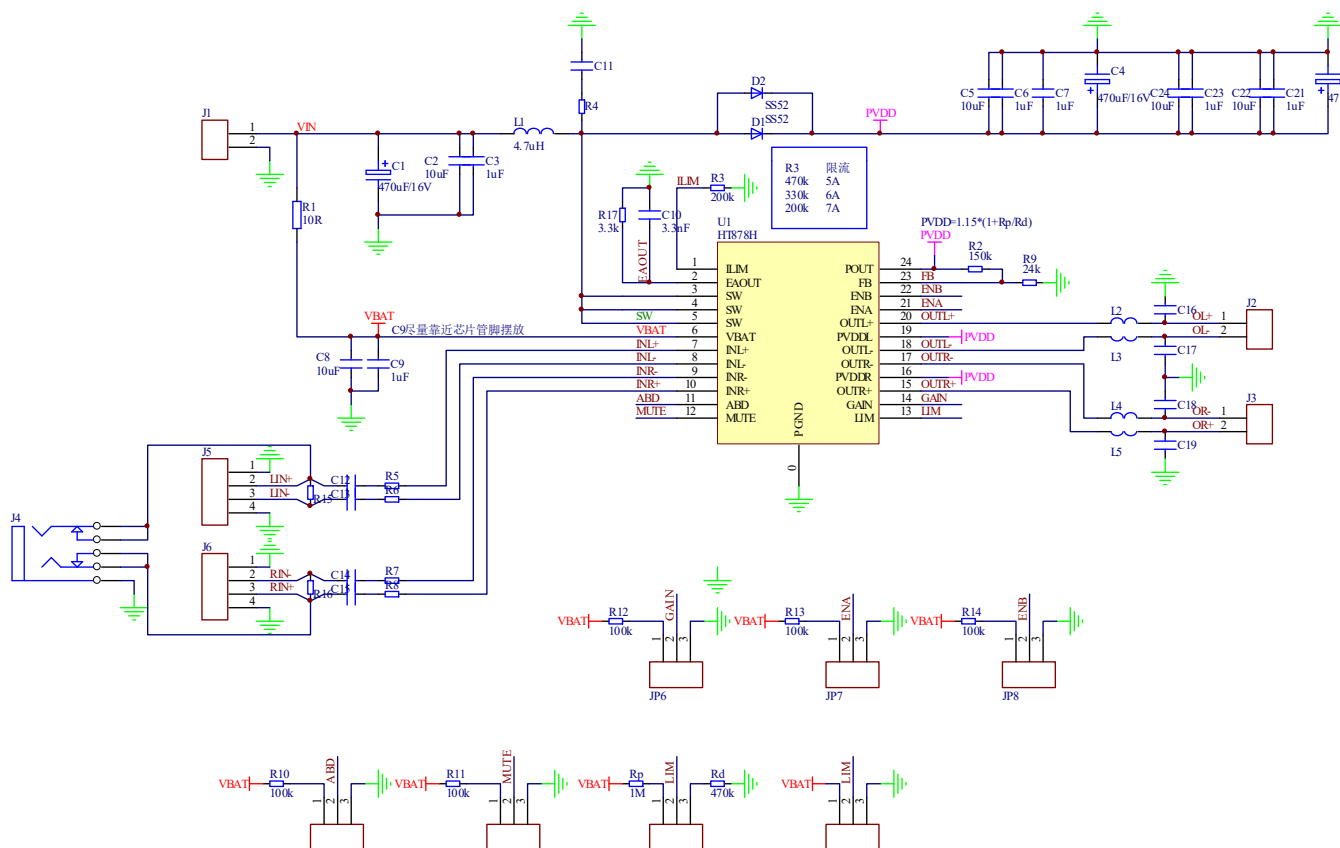

5. PCB Layout

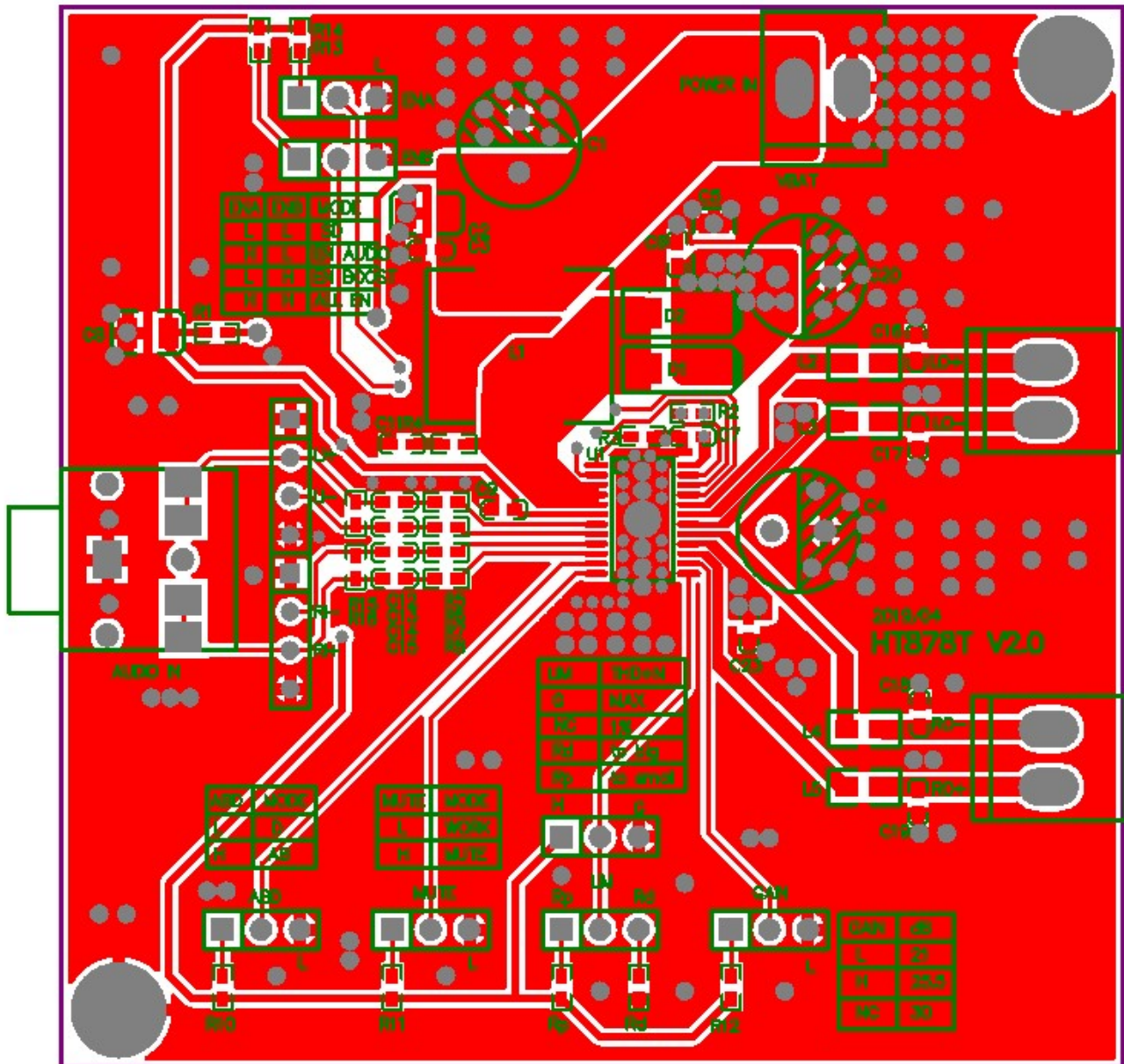

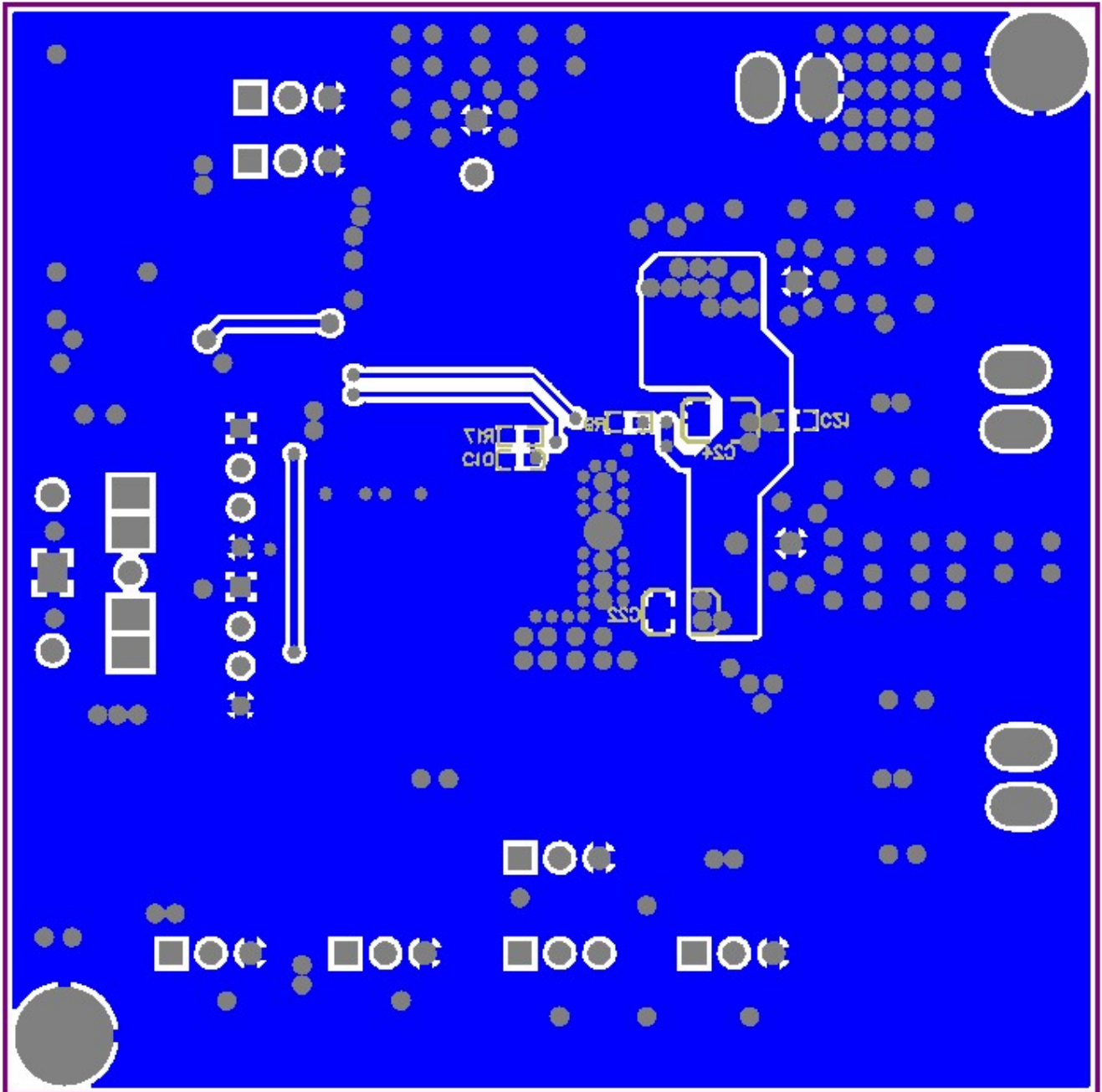

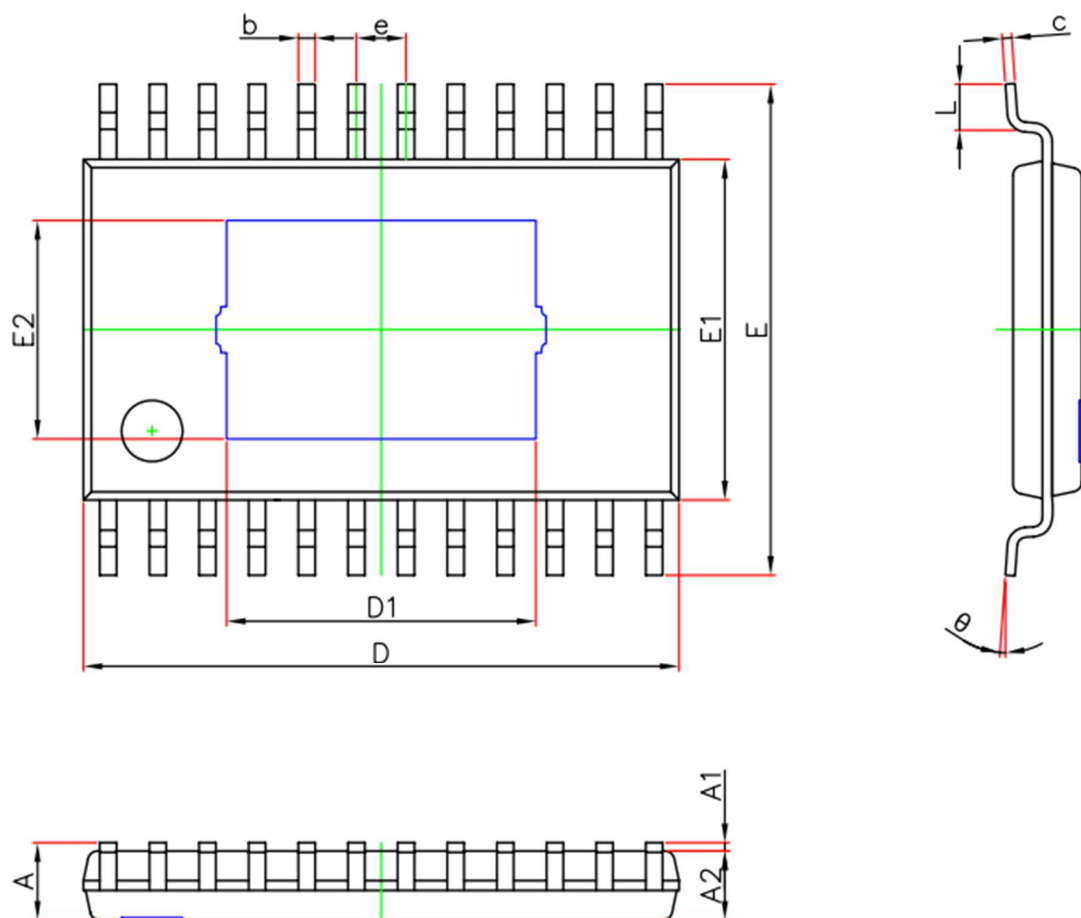
PACKAGE OUTLINE

Symbol	Dimensions In Millimeters		Dimensions In Inches	
	Min.	Max.	Min.	Max.
A	—	1.200	—	0.047
A1	0.050	0.150	0.002	0.006
A2	0.800	1.050	0.031	0.041
b	0.190	0.300	0.007	0.012
c	0.090	0.200	0.004	0.008
D	7.700	7.900	0.303	0.311
D1	3.950	4.150	0.156	0.163
E	6.250	6.550	0.246	0.258
E1	4.300	4.500	0.169	0.177
E2	2.750	2.950	0.108	0.116
e	0.650(BSC)		0.026(BSC)	
L	0.450	0.750	0.018	0.030
θ	0°	8°	0°	8°

IMPORTANT NOTICE

注意

Jiaxing Heroic Electronic Technology Co., Ltd (HT) reserves the right to make corrections, modifications, enhancements, improvements, and other changes to its products and services at any time and to discontinue any products or services. Customers should obtain the latest relevant information before placing orders and should verify that such information is current and complete.

嘉兴禾润电子科技有限公司（以下简称HT）保留对产品、服务、文档的任何修改、更正、提高、改善和其他改变，或停止提供任何产品和服务的权利。客户在下单和生产前应确保所得到的信息是最新、最完整的。

HT assumes no liability for applications assistance or customer product design. Customers are responsible for their products and applications using HT components.

HT对相关应用的说明和协助以及客户产品的板级设计不承担任何责任。

HT products are not authorized for use in safety-critical applications (such as life support devices or systems) where a failure of the HT product would reasonably be expected to affect the safety or effectiveness of that devices or systems.

HT的产品并未授权用于诸如生命维持设备等安全性极高的应用中。

The information included herein is believed to be accurate and reliable. However, HT assumes no responsibility for its use; nor for any infringement of patents or other rights of third parties which may result from its use.

本文中的相关信息是精确和可靠的，但HT并不对其负责，也不对任何可能的专利和第三方权利的侵害负责。

Following are URLs and contacts where you can obtain information or supports on any HT products and application solutions:

下面是可以联系到我公司的相关链接和联系方式：

嘉兴禾润电子科技有限公司

Jiaxing Heroic Electronic Technology Co., Ltd.

地址：浙江省嘉兴市凌公塘路3339号JRC大厦A座三层

Add: A 3rd floor, JRC Building, No. 3339, LingGongTang Road, Jiaxing, Zhejiang Province

Sales: 0573-82585539, sales@heroic.com.cn

Support: 0573-82586151, support@heroic.com.cn

Fax: 0573-82585078

Website: www.heroic.com.cn; wap.heroic.com.cn

Wechat MP: HEROIC_JX

请及时关注禾润官方微信公众号，随时获取最新产品信息和技术资料！

