

## Inductors for power circuits

## Wound ferrite

## VLS-EX-H series (for automotive)



AEC-Q200

## VLS5045EX-H type



## FEATURES

- Magnetic shield type wound inductor for power circuits.
- High magnetic shield construction achieved by a ferrite magnetic material and compatible with high-density mounting.
- Larger current and lower R<sub>dc</sub> were achieved by optimizing the ferrite core figure.
- Operating temperature range: -40 to +125 °C (including self-temperature rise)
- Compliant with AEC-Q200

## APPLICATION

- Automotive-related equipment (ECM, airbags, headlights, electronic power steering, meters, ABS, other)

## PART NUMBER CONSTRUCTION

VLS	5045	EX	-	1R0	N	-	H
Series name	LxWxH dimensions 5.0x5.3x4.5 mm	Internal code		Inductance (μH)	Inductance tolerance		Internal code

## CHARACTERISTICS SPECIFICATION TABLE

L (μH)	Measuring frequency		DC resistance (Ω)±30%	Rated current*		Part No.
	Tolerance	(kHz)		Isat (A)max.	Itemp (A)typ.	
1.0	±30%	100	0.015	8.9	5.1	<a href="#">VLS5045EX-1R0N-H</a>
1.5	±30%	100	0.017	7.4	5.0	<a href="#">VLS5045EX-1R5N-H</a>
2.2	±30%	100	0.022	6.4	4.7	<a href="#">VLS5045EX-2R2N-H</a>
3.3	±30%	100	0.027	5.2	4.2	<a href="#">VLS5045EX-3R3N-H</a>
4.7	±20%	100	0.036	4.4	3.2	<a href="#">VLS5045EX-4R7M-H</a>
6.8	±20%	100	0.046	3.6	2.9	<a href="#">VLS5045EX-6R8M-H</a>
10	±20%	100	0.061	3.1	2.5	<a href="#">VLS5045EX-100M-H</a>
15	±20%	100	0.110	2.2	1.9	<a href="#">VLS5045EX-150M-H</a>
22	±20%	100	0.125	2.0	1.8	<a href="#">VLS5045EX-220M-H</a>
33	±20%	100	0.24	1.5	1.3	<a href="#">VLS5045EX-330M-H</a>
47	±20%	100	0.30	1.3	1.0	<a href="#">VLS5045EX-470M-H</a>
68	±20%	100	0.41	1.1	0.9	<a href="#">VLS5045EX-680M-H</a>
100	±20%	100	0.58	0.8	0.7	<a href="#">VLS5045EX-101M-H</a>
150	±20%	100	0.73	0.56	0.61	<a href="#">VLS5045EX-151M-H</a>
220	±20%	100	1.05	0.45	0.45	<a href="#">VLS5045EX-221M-H</a>

\* Rated current: smaller value of either Isat or Itemp.

Isat: When based on the inductance change rate (30% below the initial L value)

Itemp: When based on the temperature increase (temperature increase of 40°C by self heating)

## Measurement equipment

Measurement item	Product No.	Manufacturer
L	4294A	Keysight Technologies, Inc. (formerly Hewlett-Packard)
DC resistance	34420A	Keysight Technologies, Inc. (formerly Hewlett-Packard)
Rated current Isat	4284A+42841A+42842A	Keysight Technologies, Inc. (formerly Hewlett-Packard)

\* Equivalent measurement equipment may be used.

## TEMPERATURE RANGE, INDIVIDUAL WEIGHT

Operating temperature range*	Storage temperature range**	Individual weight
-40 to 125 °C	-40 to 125 °C	0.4 g

\* Operating temperature range includes self-temperature rise.

\*\* The storage temperature range is for after the assembly.



⚠ Please be sure to request delivery specifications that provide further details on the features and specifications of the products for proper and safe use. (1/4)  
Please note that the contents may change without any prior notice due to reasons such as upgrading.

20200805

inductor\_automotive\_power\_vls5045ex-h\_en

# VLS5045EX-H type

## L FREQUENCY CHARACTERISTICS

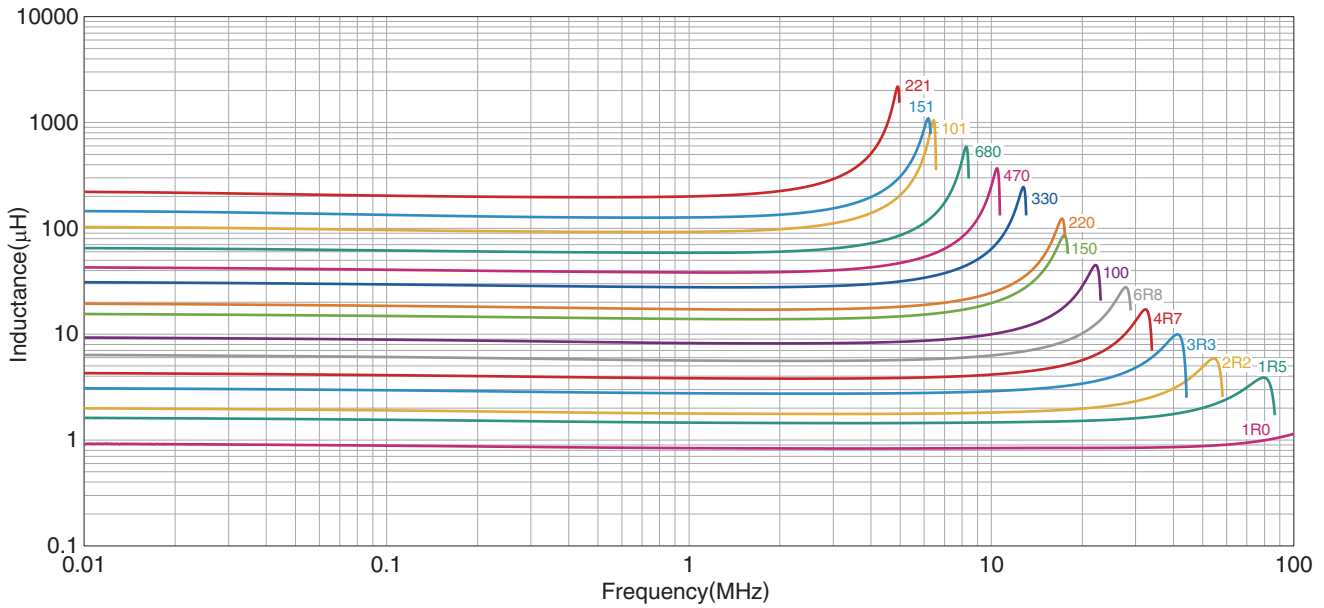

Measurement equipment

Product No.	Manufacturer
4294A	Keysight Technologies, Inc. (formerly Hewlett-Packard)

\* Equivalent measurement equipment may be used.

## INDUCTANCE VS. DC BIAS CHARACTERISTICS

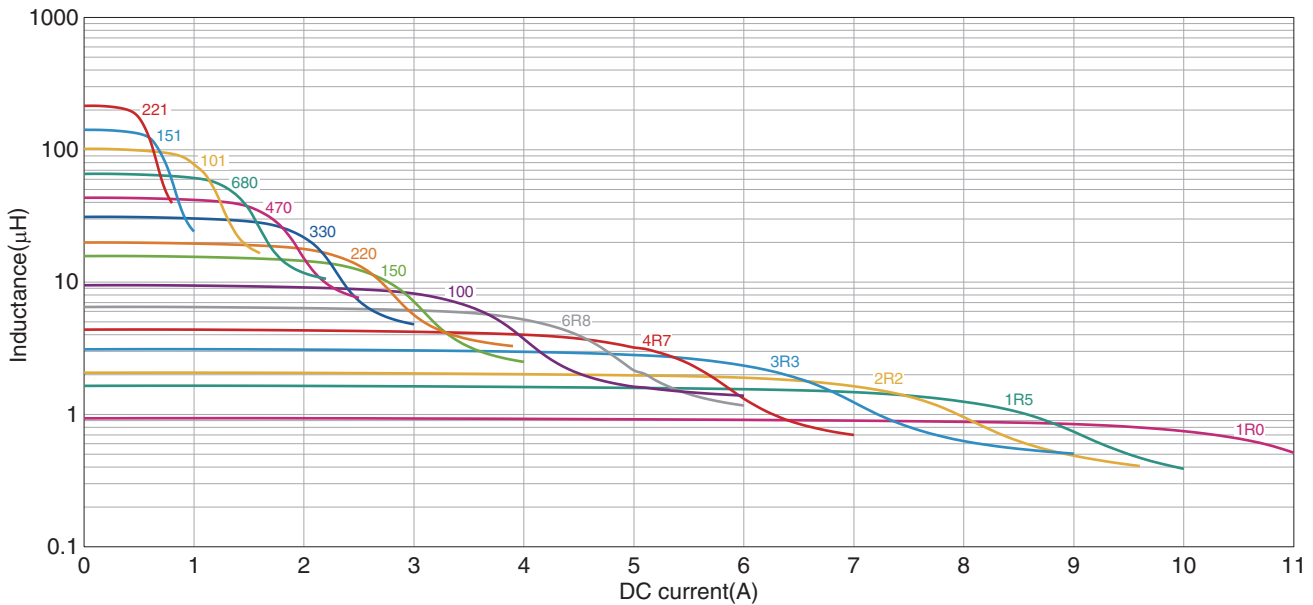

Measurement equipment

Product No.	Manufacturer
4284A+42841A+42842A	Keysight Technologies, Inc. (formerly Hewlett-Packard)

\* Equivalent measurement equipment may be used.

# VLS5045EX-H type

## SHAPE & DIMENSIONS

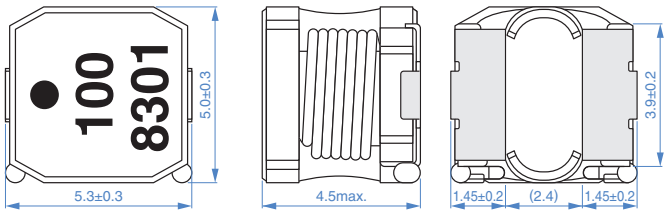

Dimensions in mm

## PACKAGING STYLE

### REEL DIMENSIONS

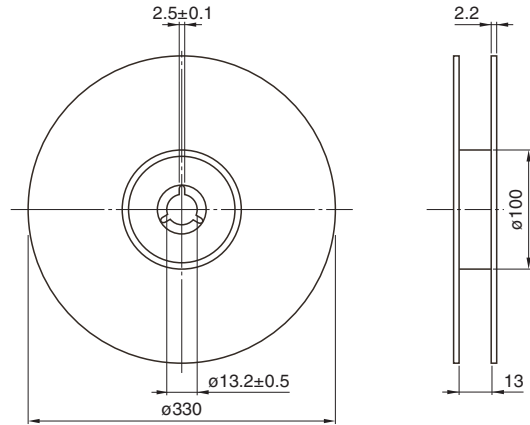

Dimensions in mm

## RECOMMENDED LAND PATTERN

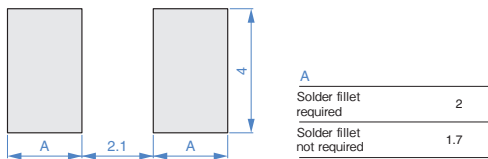

Dimensions in mm

### TAPE DIMENSIONS

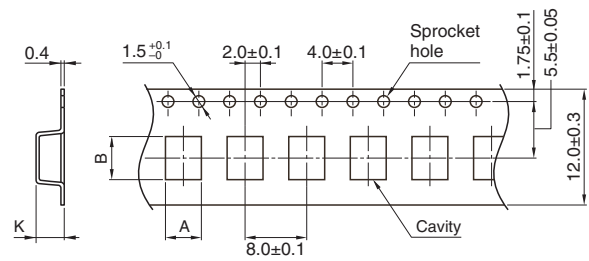

Dimensions in mm

Type	A	B	K
VLS5045EX-H	5.35	5.65	4.7

## RECOMMENDED REFLOW PROFILE

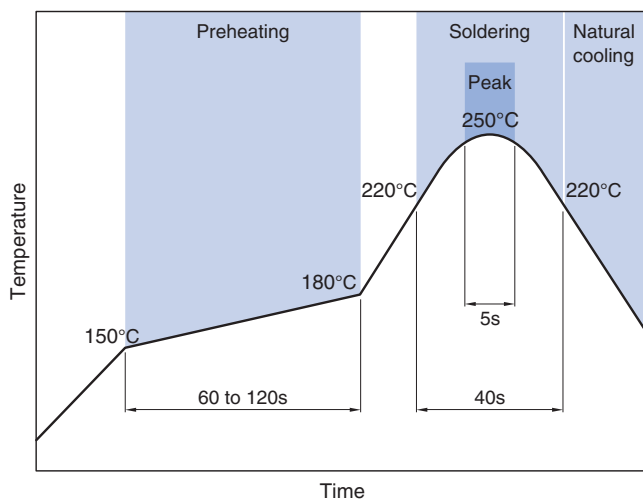

### PACKAGE QUANTITY

Package quantity	1500 pcs/reel
------------------	---------------

## REMINDERS FOR USING THESE PRODUCTS

Before using these products, be sure to request the delivery specifications.

### SAFETY REMINDERS

Please pay sufficient attention to the warnings for safe designing when using this products.

#### REMINDERS

- The storage period is within 12 months. Be sure to follow the storage conditions (temperature: 5 to 40°C, humidity: 0 to 75% RH or less).  
If the storage period elapses, the soldering of the terminal electrodes may deteriorate.
- Do not use or store in locations where there are conditions such as gas corrosion (salt, acid, alkali, etc.).
- Before soldering, be sure to preheat components.  
The preheating temperature should be set so that the temperature difference between the solder temperature and chip temperature does not exceed 150°C.
- Soldering corrections after mounting should be within the range of the conditions determined in the specifications.  
If overheated, a short circuit, performance deterioration, or lifespan shortening may occur.
- When embedding a printed circuit board where a chip is mounted to a set, be sure that residual stress is not given to the chip due to the overall distortion of the printed circuit board and partial distortion such as at screw tightening portions.
- Self heating (temperature increase) occurs when the power is turned ON, so the tolerance should be sufficient for the set thermal design.
- Carefully lay out the coil for the circuit board design of the non-magnetic shield type.  
A malfunction may occur due to magnetic interference.
- Use a wrist band to discharge static electricity in your body through the grounding wire.
- Do not expose the products to magnets or magnetic fields.
- Do not use for a purpose outside of the contents regulated in the delivery specifications.
- The products described in this catalog are intended to be installed in automobiles or automotive electronic equipment (AV equipment, telecommunications equipment, home appliances, amusement equipment, computer equipment, personal equipment, office equipment, measurement equipment, industrial robots) and to be used in automobiles (including the case where the said automotive product is mounted in a vehicle) or standard applications as general electronic equipment in automotive applications or standard applications as general electronic equipment in automotive applications in accordance with the scope and conditions described in this specification, while the said automotive or general electronic equipment including the said product is intended to be used in the usual operation and usage methods, respectively. Other than automotive or automotive products are not designed or warranted to meet the requirements of the applications listed below, whose performance and/or quality requires a more stringent level of safety or reliability, or whose failure, malfunction or defect could cause serious damage to society, person or property.

Please understand that we are not responsible for any damage or liability caused by use of the products in any of the applications below or for any other use exceeding the range or conditions set forth in this specification sheet.

If you intend to use the products in the applications listed below or if you have special requirements exceeding the range or conditions set forth in this specification, please contact us.

- |   |  |
|---|--|
| (1) Aerospace/aviation equipment                                  | (8) Public information-processing equipment                                  |
| (2) Transportation equipment (cars, electric trains, ships, etc.) | (9) Military equipment   |
| (3) Medical equipment   | (10) Electric heating apparatus, burning equipment                           |
| (4) Power-generation control equipment                            | (11) Disaster prevention/crime prevention equipment                          |
| (5) Atomic energy-related equipment                               | (12) Safety equipment  |
| (6) Seabed equipment  | (13) Other applications that are not considered general-purpose applications |
| (7) Transportation control equipment                              |  |

When designing your equipment even for general-purpose applications, you are kindly requested to take into consideration securing protection circuit/device or providing backup circuits in your equipment.