



SMAF Plastic-Encapsulate Diodes

SS52F THRU SS520F Schottky Rectifier Diodes

Features

- $I_{F(AV)}$ 5A
- V_{RRM} 20V-200V
- High surge current capability
- Polarity: Color band denotes cathode

Applications

- Rectifier

Marking

- SS5X
X : From 2 To 20

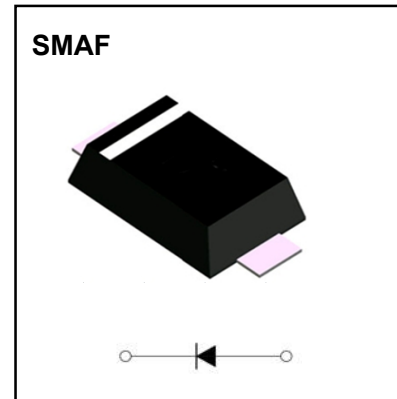

Limiting Values(Absolute Maximum Rating)

Item	Symbol	Unit	Test Conditions	SS5														
				2F	3F	4F	5F	6F	8F	10F	15F	20F						
Repetitive Peak Reverse Voltage	V_{RRM}	V		20	30	40	50	60	80	100	150	200						
Maximum RMS Voltage	V_{RMS}	V		14	21	28	35	42	56	70	105	140						
Average Forward Current	$I_{F(AV)}$	A	60Hz Half-sine wave, Resistance load, TL(Fig.1)	5.0														
Surge(Non-repetitive)Forward Current	I_{FSM}	A	60Hz Half-sine wave, 1 cycle, $T_a=25^\circ\text{C}$	150														
Junction Temperature	T_J	$^\circ\text{C}$		-55~+125					-55~+150									
Storage Temperature	T_{STG}	$^\circ\text{C}$		-55 ~ +150														

Electrical Characteristics ($T = 25^\circ\text{C}$ Unless otherwise specified)

Item	Symbol	Unit	Test Condition	SS5														
				2F	3F	4F	5F	6F	8F	10F	15F	20F						
Peak Forward Voltage	V_F	V	$I_F=5.0\text{A}$	0.55		0.70		0.85		0.95								
Peak Reverse Current	I_{RRM1}	mA	$V_{RM}=V_{RRM}$	$T_a=25^\circ\text{C}$		0.5		0.2										
	I_{RRM2}			$T_a=100^\circ\text{C}$		10		5.0										
Thermal Resistance(Typical)	$R_{\theta J-A}$	$^\circ\text{C}/\text{W}$	Between junction and ambient		55													
	$R_{\theta J-L}$		Between junction and terminal		17													

Notes:

Thermal resistance from junction to ambient and from junction to lead mounted on P.C.B. with 0.2" x 0.2" (5.0 mm x 5.0 mm) copper pad areas

Typical Characteristics

FIG.1: FORWARD CURRENT DERATING CURVE

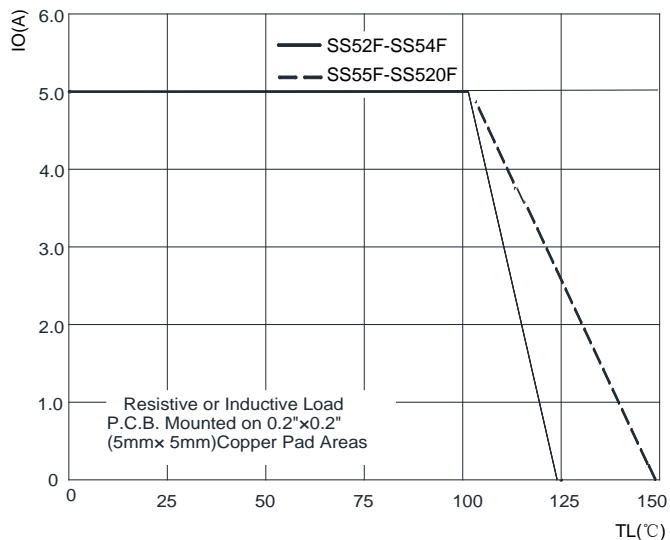

FIG.2: MAXIMUM NON-REPETITIVE FORWARD URGE CURRENT

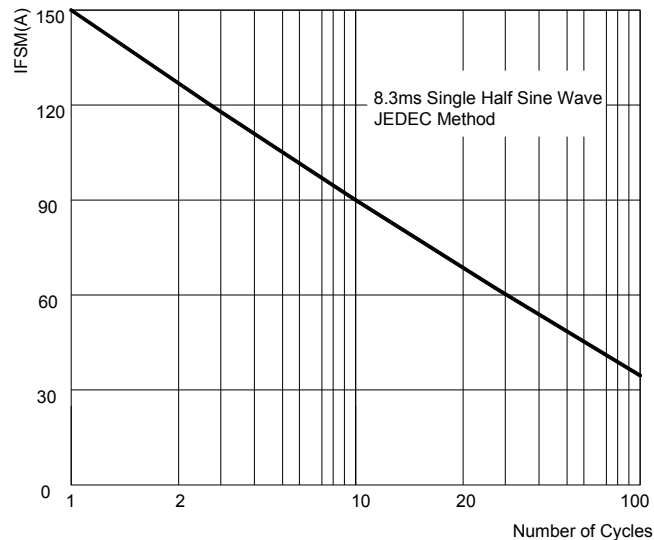

FIG.3: TYPICAL FORWARD CHARACTERISTICS

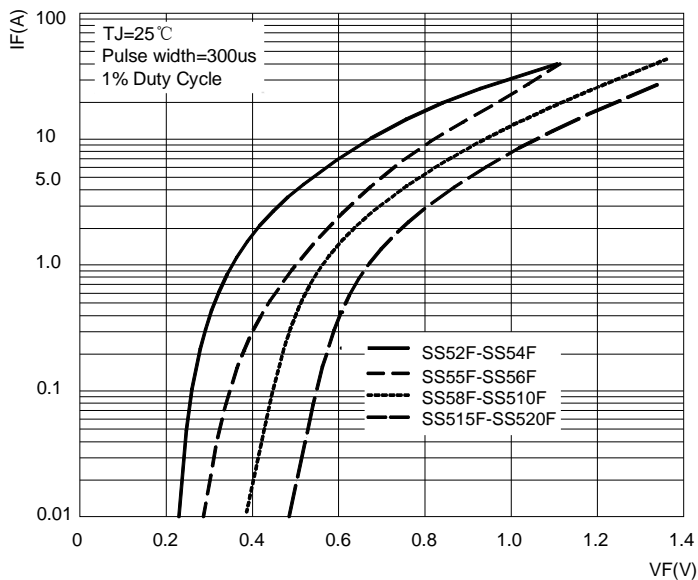
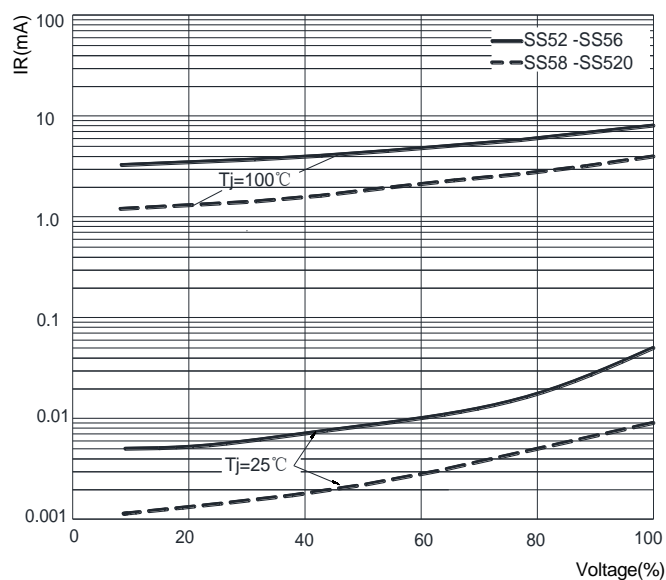

FIG.4: TYPICAL REVERSE CHARACTERISTICS



SMAF Package Outline Dimensions



Dimensions in inches and (millimeters)

SMAF Suggested Pad Layout

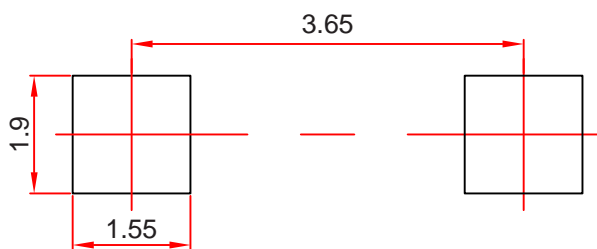

Note:

1. Controlling dimension: in millimeters.
2. General tolerance: ± 0.05 mm.
3. The pad layout is for reference purposes only.

NOTICE

JSCJ reserves the right to make modifications, enhancements, improvements, corrections or other changes without further notice to any product herein. JSCJ does not assume any liability arising out of the application or use of any product described herein.

Reel Taping Specifications For Surface Mount Devices- SMAF

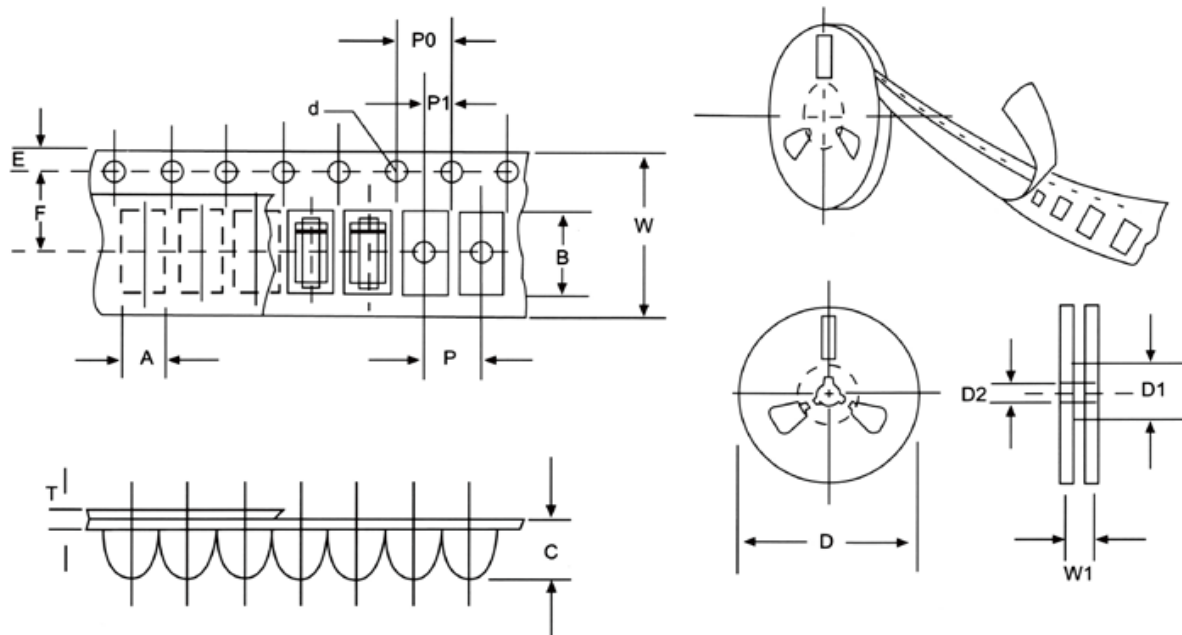

FIG: CONFIGURATION OF SURFACE MOUNTED DEVICES TAPING

ITEM	SYMBOL	SMAF mm(inch)
Carrier width	A	2.83+0.1(0.112+0.004)
Carrier length	B	4.90+0.1(0.193+0.004)
Carrier depth	C	1.45+0.1(0.057+0.004)
Sprocket hole	d	1.55+0.05(0.061+0.002)
Reel outside diameter	D	178+2.0(7.0+0.079)
Reel inner diameter	D1	54±1.0(2.13±0.039)
Feed hole diameter	D2	13+0.5(0.512+0.020)
Sprocket hole position	E	1.75+0.1(0.069+0.004)
Punch hole position	F	5.5+0.05(0.217+0.002)
Punch hole pitch	P	4.0+0.1(0.157+0.004)
Sprocket hole pitch	P0	4.0+0.1(0.157+0.004)
Embossment center	P1	2.0+0.1(0.079+0.004)
Total tape thickness	T	0.23-0.29(0.009-0.011)
Tape width	W	12.0+0.1(0.472+0.004)
Reel width	W1	16.8+2.0(0.661+0.079)

NOTE: Devices are packed in accordance with EIA standard RS-481-A and specification given above.