

### General Description

The TPLP3985 is a low-dropout (LDO) voltage regulator with enable function that operates from a 1.2V to 5.5V supply. It provides up to 300mA of output current in miniaturized packaging.

The feature of 15 $\mu$ A low quiescent current and 0.5 $\mu$ A shutdown current are ideal for the battery application with long service life. The other features include current limit function, over temperature protection and output discharge function.

### Features

- 15 $\mu$ A Ground Current at no Load
- $\pm 2\%$  Output Accuracy
- 300mA Output Current
- 10nA Disable Current (by option)
- Wide Operating Input Voltage Range: 1.2V to 5.5V
- Dropout Voltage: 0.22V at 300mA ( $V_{OUT}=3.3V$ )
- Support Fixed Output Voltage 1.2V, 1.5V, 1.6V, 1.8V, 2.5V, 2.8V, 3.0V, 3.3V
- Stable with Ceramic or Tantalum Capacitor
- Current Limit Protection
- Over-Temperature Protection
- SOT23-5

### Applications

- Portable, Battery Powered Equipment
- Low Power Microcontrollers
- Laptop, Palmtops and PDAs
- Wireless Communication Equipment
- Audio/Video Equipment

### Ordering Information

**TPLP3985IM5X-3.3**

Output voltage: 1.2=1.2V  
1.5=1.5V  
1.8=1.8V  
3.0=3.0V  
3.3=3.3V  
3.6=3.6V

IM5X=SOT23-5

## PIN CONFIGURATION

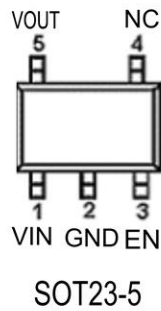

## Typical Application Circuit

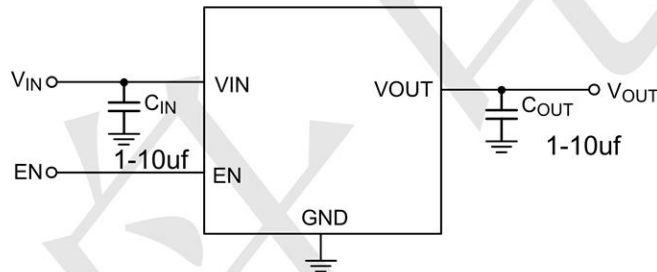

## ABSOLUTE MAXIMUM RATINGS

Parameter		Value	Unit
Supply Voltage		-0.3~+6.5	V
Power Dissipation	SOT-23-5	400	mW
	SOT-89	600	mW
Thermal Resistance, Junction-to-Ambient	SOT-23-5	380	°C/W
	SOT-89	180	°C/W
Operating Junction Temperature		-40 ~ +125	°C
Storage Temperature Range		-65 ~ +150	°C
Lead Temperature (Soldering, 10 sec)		300	°C

### Electrical Characteristics (T =25°C unless otherwise noted)

(V<sub>IN</sub>=5V, V<sub>EN</sub>=5V, T<sub>A</sub>=25°C, unless otherwise specified) (Note 1)

PARAMETER	TEST CONDITIONS	SYMBOL	MIN.	TYP.	MAX.	UNIT
Supply Voltage		V <sub>IN</sub>	1.2		5.5	V
DC Output Voltage Accuracy	I <sub>LOAD</sub> =0.1mA		-2		2	%
SNS Input Current	SNS=V <sub>OUT</sub>	I <sub>SNS</sub>		0.5		μA
Dropout Voltage (Note 2)	I <sub>LOAD</sub> =300mA, V <sub>OUT</sub> ≥3V	V <sub>DROP_3V</sub>		0.18		V
	I <sub>LOAD</sub> =300mA, V <sub>OUT</sub> =2.8V	V <sub>DROP_2.8V</sub>		0.23		
	I <sub>LOAD</sub> =300mA, V <sub>OUT</sub> =2.5V	V <sub>DROP_2.5V</sub>		0.23		
	I <sub>LOAD</sub> =300mA, V <sub>OUT</sub> =1.8V	V <sub>DROP_1.8V</sub>		0.28		
	I <sub>LOAD</sub> =300mA, V <sub>OUT</sub> =1.5V	V <sub>DROP_1.5V</sub>		0.36		
	I <sub>LOAD</sub> =300mA, V <sub>OUT</sub> =1.2V	V <sub>DROP_1.2V</sub>		0.45		
GND Current	I <sub>LOAD</sub> =0mA	I <sub>Q</sub>		15		μA
Shutdown GND Current	V <sub>EN</sub> =0V, V <sub>OUT</sub> =0V	I <sub>SD</sub>		0.1	0.5	μA
V <sub>OUT</sub> Shutdown Leakage Current	V <sub>EN</sub> =0V, V <sub>OUT</sub> =0V	I <sub>LEAK</sub>		0.1	0.5	μA
Enable Threshold Voltage	EN Rising	V <sub>IH</sub>	1.0			V
	EN Falling	V <sub>IL</sub>			0.4	
EN Input Current	V <sub>EN</sub> =5V	I <sub>EN</sub>		10	100	nA
Line Regulation	I <sub>LOAD</sub> =30mA, 1.5V≤V <sub>IN</sub> ≤5.5V or (V <sub>OUT</sub> +0.2V)≤V <sub>IN</sub> ≤5.5V	ΔLINE		0.2		%
Load Regulation	10mA≤I <sub>LOAD</sub> ≤300mA	ΔLOAD		0.2		%
Output Current Limit	V <sub>OUT</sub> =0V	I <sub>LIM</sub>	450	500		mA
Power Supply Rejection Ratio	V <sub>OUT</sub> =1.2V, I <sub>LOAD</sub> =5mA, V <sub>IN</sub> =2V, f=100Hz	PSRR		80		dB
	V <sub>OUT</sub> =1.2V, I <sub>LOAD</sub> =5mA, V <sub>IN</sub> =2V, f=1kHz			75		
Output Voltage Noise	V <sub>IN</sub> =3.5V, I <sub>LOAD</sub> =0.1A, BW=10Hz to 100kHz, C <sub>OUT</sub> =1μF, V <sub>OUT</sub> =1.2V			80		μV <sub>RMS</sub>
	V <sub>IN</sub> =3.5V, I <sub>LOAD</sub> =0.1A, BW=10Hz to 100kHz, C <sub>OUT</sub> =1μF, V <sub>OUT</sub> =2.8V			120		
Thermal Shutdown Temperature	I <sub>LOAD</sub> =10mA	T <sub>SD</sub>		155		°C
Thermal Shutdown Hysteresis	I <sub>LOAD</sub> =10mA	ΔT <sub>SD</sub>		15		°C
Discharge Resistance	V <sub>EN</sub> =0V, V <sub>OUT</sub> =0.1V			100		Ω

**BLOCK DIAGRAM**

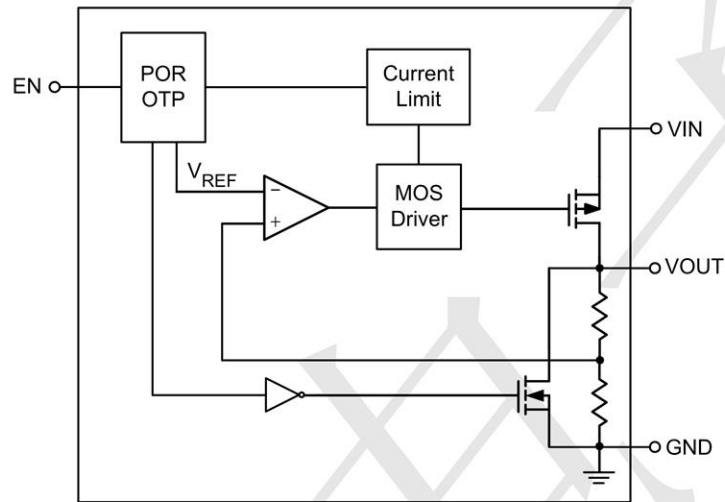

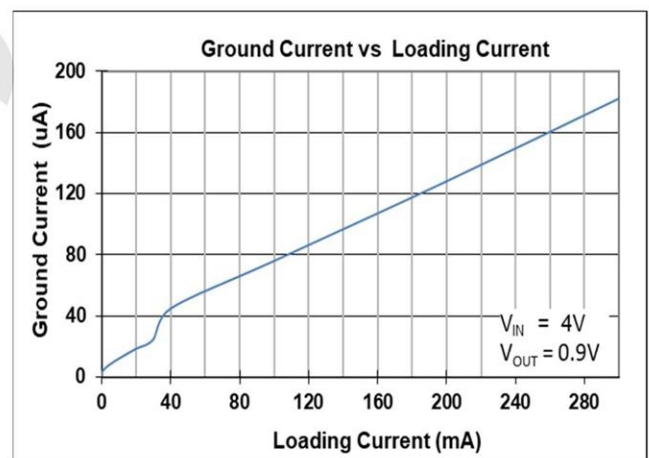
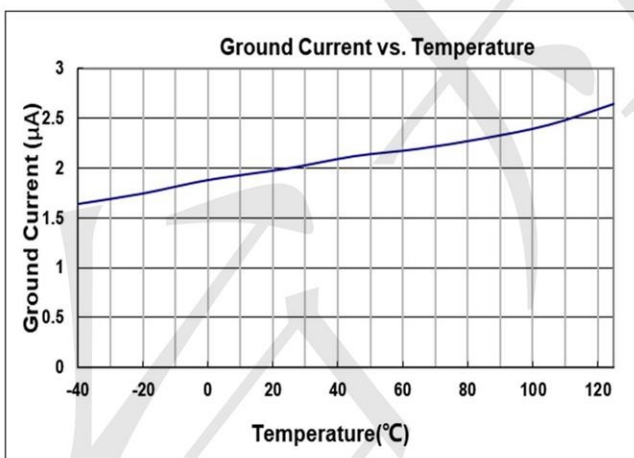
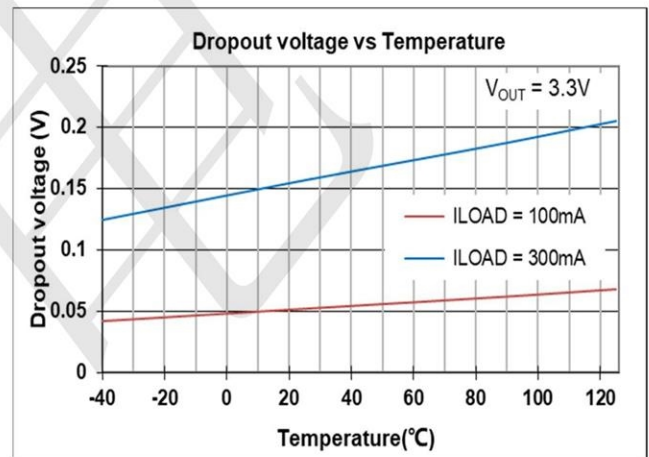
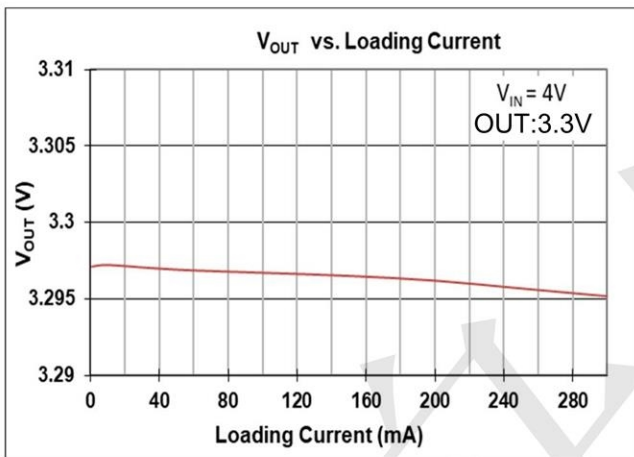
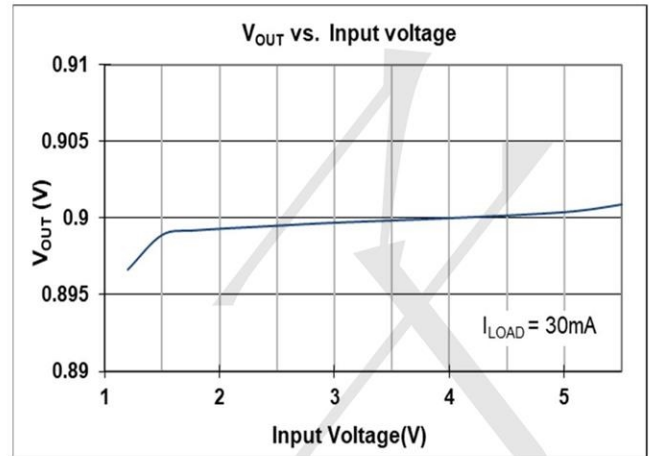
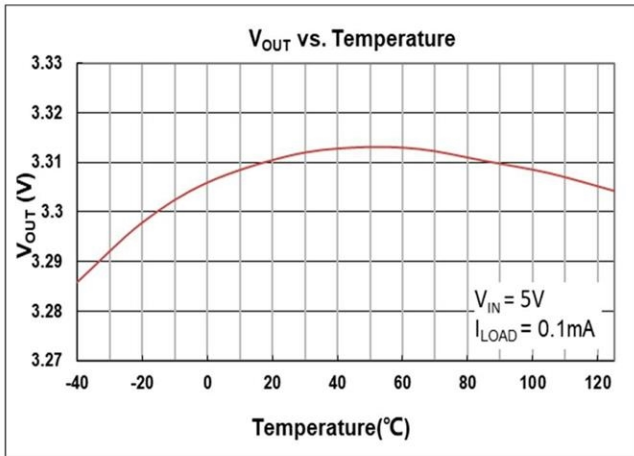

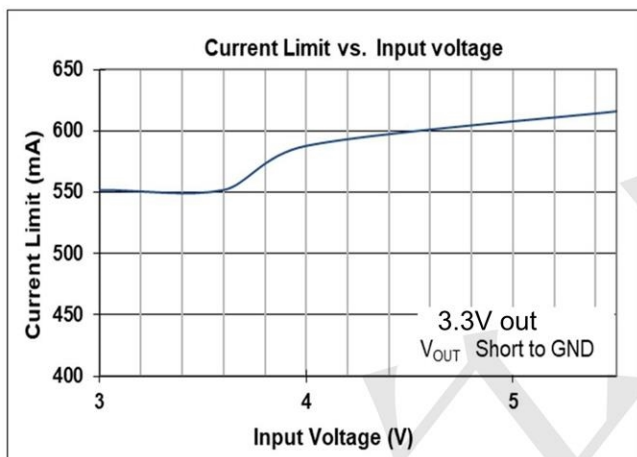
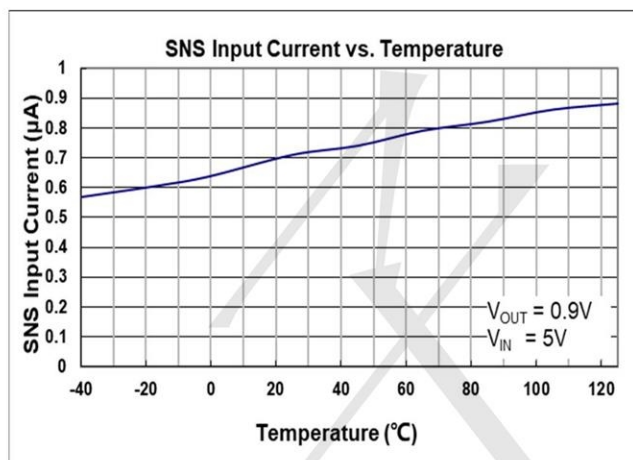
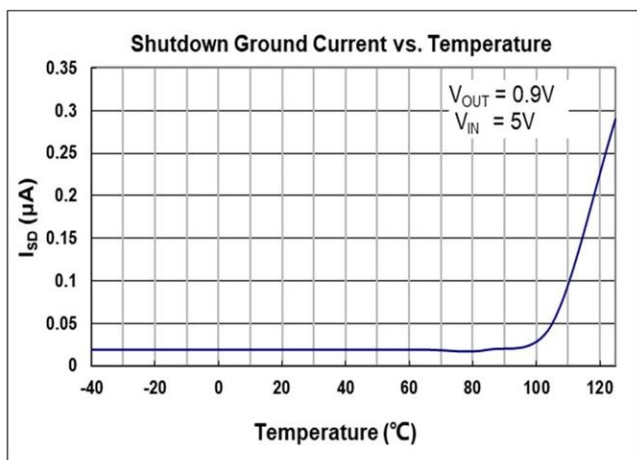

### Current Limit Response

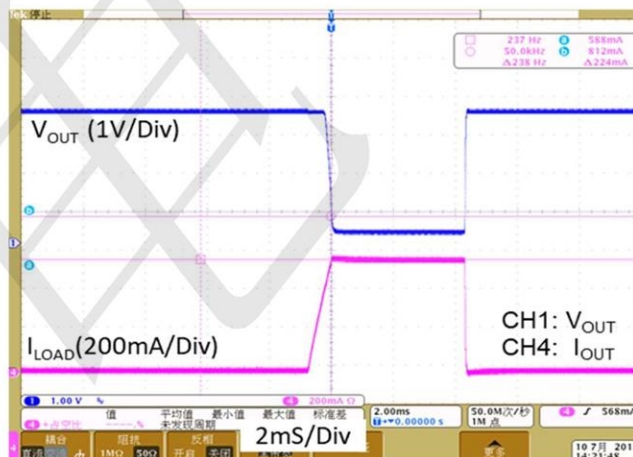

### Load Transient Response I

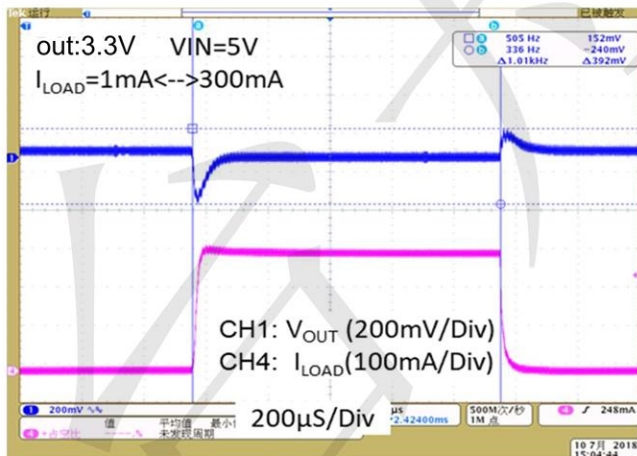

### Load Transient Response II

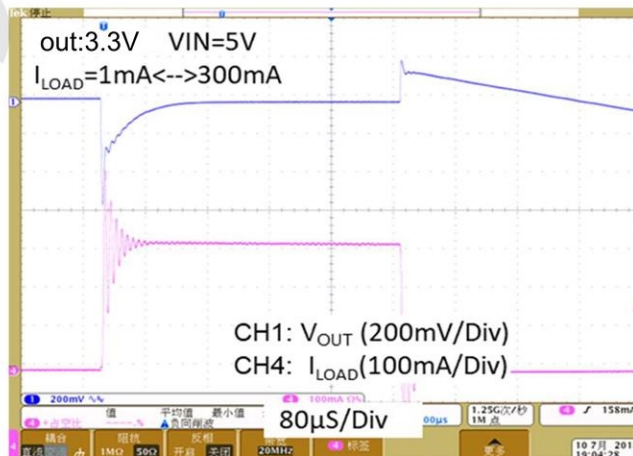

Line Transient Response

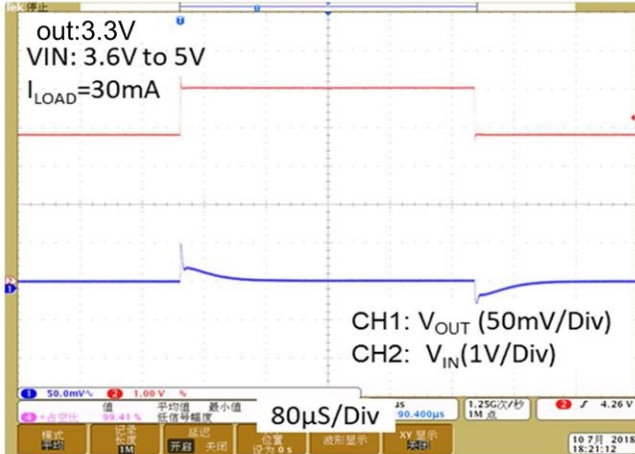

$V_{OUT}$  Turn On/Off by EN

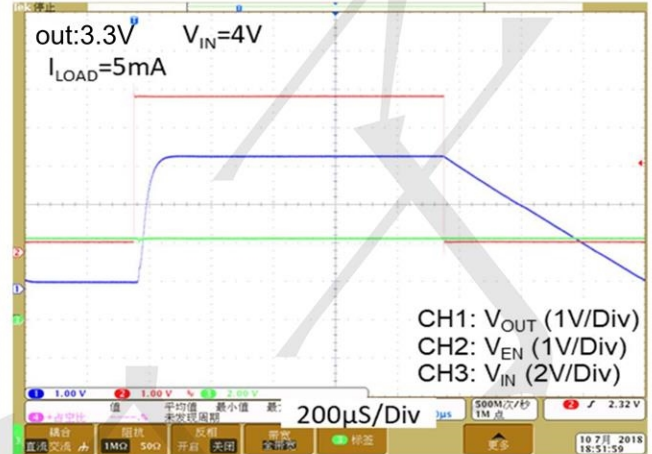

**Package informantion**

**3-pin SOT23-5 Outline Dimensions**

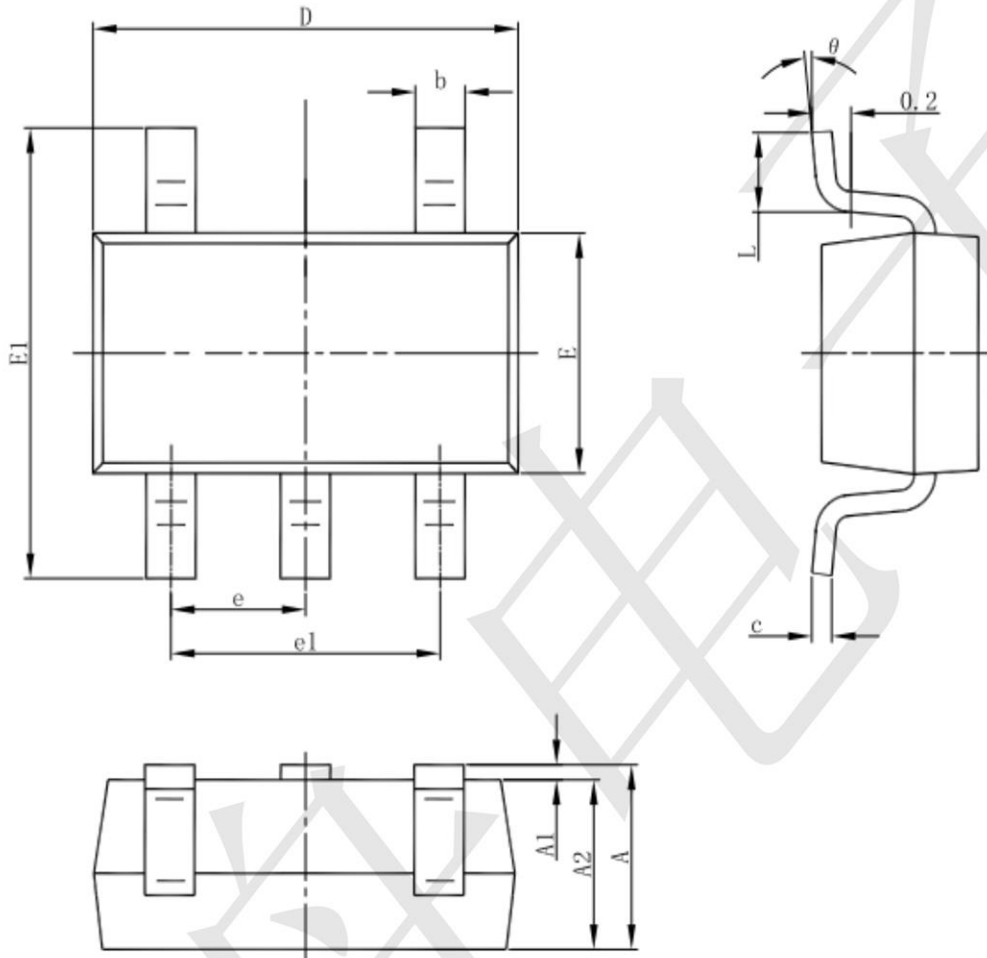

Symbol	Dimensions In Millimeters		Dimensions In Inches	
	Min	Max	Min	Max
A	1.050	1.250	0.041	0.049
A1	0.000	0.100	0.000	0.004
A2	1.050	1.150	0.041	0.045
b	0.300	0.500	0.012	0.020
c	0.100	0.200	0.004	0.008
D	2.820	3.020	0.111	0.119
E	1.500	1.700	0.059	0.067
E1	2.650	2.950	0.104	0.116
e	0.950(BSC)		0.037(BSC)	
e1	1.800	2.000	0.071	0.079
L	0.300	0.600	0.012	0.024
θ	0°	8°	0°	8°