

## PRODUCT IDENTIFICATION

### 1. Scope

This specification applies to FTK series of wire wound SMD type power inductors

### 2. Product Description and Identification (Part Number)

Description

Wire Wound SMD Type Power Inductor, FTKB,XX  $\mu\text{H} \pm X\%$  @XXX KHz/XXXV, XXX  $\Omega$ , XXXmA.



## PRODUCT IDENTIFICATION

①	Type	②	Configuration
FTK	Wire Wound SMD Type Power Inductors (With Metallic Base)	B	B Type Base
③	External Dimensions (L X H) (mm)	④	Nominal Inductance
0602~1207		Example	Nominal Value
		1R0	1.0 $\mu\text{H}$
		100	10 $\mu\text{H}$
		101	100 $\mu\text{H}$
⑤	Inductance Tolerance	⑥	Packing
M	$\pm 20\%$	T	Tape Carrier Package
N	$\pm 30\%$		

## ELECTRICAL CHARACTERISTICS

(1) Operating and storage temperature range (individual chip without packing):  $-40^{\circ}\text{C}$  to  $+105^{\circ}\text{C}$

(2) Storage temperature range (packaging conditions):  $-10^{\circ}\text{C}$  ~  $+40^{\circ}\text{C}$  and RH 70% (Max.)

## SHAPE AND DIMENSIONS

(1) Dimensions and recommended PCB pattern for reflow soldering: See Fig.4-1, Fig.4-2 and Table 4-1.

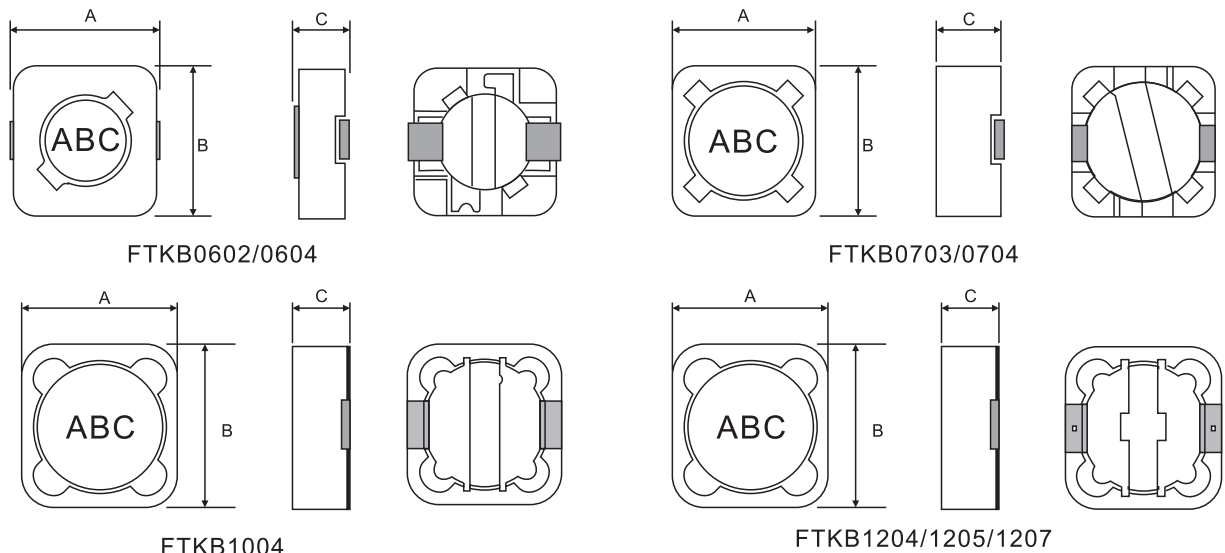

**Fig. 4-1**

Recommended Land Pattern

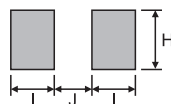

**Fig. 4-2**

## SHAPE AND DIMENSIONS

[Table 4-1]

Unit: mm

Series	A max.	B max.	C max.	I typ.	J typ.	H typ.
FTKB0602	7.00	6.80	3.0	1.4	4.6	1.9
FTKB0604	7.00	6.80	5.0	1.4	4.6	1.9
FTKB0703	7.80	7.80	4.0	1.6	4.8	2.2
FTKB0704	7.80	7.80	5.0	1.6	4.8	2.2
FTKB1004	10.5	10.5	5.0	2.0	6.8	4.4
FTKB1204	12.5	12.5	5.0	2.9	7.0	5.4
FTKB1205	12.5	12.5	6.0	2.9	7.0	5.4
FTKB1207	12.5	12.5	8.0	2.9	7.0	5.4

(2) Structure and Components: See Table 4-2

[Table 4-2]

Symbol	Components	Material
A	MARK	Ink
B	DRUM CORE	Ferrite
C	WIRE	Polyurethane copper wire
D	RING CORE	Ferrite
E	GLUE	Epoxy resin
F	ELECTRODE	Copper plated with Sn

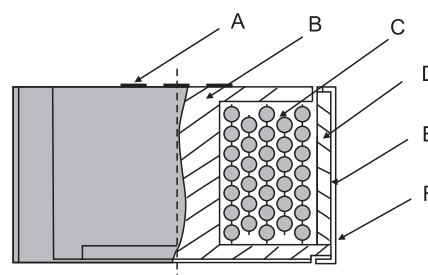

## SPECIFICATIONS

### FTKB0602 TYPE

Part Number	Inductance	L Test Condition	Max. DC Resistance	Max. Rated Current
Units	$\mu\text{H}$	Hz, V	$\Omega$	A
Symbol	L	-	DCR	$I_r$
FTKB0602-3R3NT	3.3 $\pm$ 30%	100k, 0.3V	0.068	1.94
FTKB0602-4R7NT	4.7 $\pm$ 30%	100k, 0.3V	0.080	1.63
FTKB0602-5R6NT	5.6 $\pm$ 30%	100k, 0.3V	0.096	1.40
FTKB0602-100MT	10 $\pm$ 20%	1k, 0.3V	0.150	1.10
FTKB0602-120MT	12 $\pm$ 20%	1k, 0.3V	0.200	1.00
FTKB0602-150MT	15 $\pm$ 20%	1k, 0.3V	0.230	0.90
FTKB0602-180MT	18 $\pm$ 20%	1k, 0.3V	0.270	0.80
FTKB0602-220MT	22 $\pm$ 20%	1k, 0.3V	0.340	0.74
FTKB0602-270MT	27 $\pm$ 20%	1k, 0.3V	0.380	0.66
FTKB0602-330MT	33 $\pm$ 20%	1k, 0.3V	0.450	0.59
FTKB0602-390MT	39 $\pm$ 20%	1k, 0.3V	0.490	0.54
FTKB0602-470MT	47 $\pm$ 20%	1k, 0.3V	0.690	0.50
FTKB0602-560MT	56 $\pm$ 20%	1k, 0.3V	0.780	0.46
FTKB0602-680MT	68 $\pm$ 20%	1k, 0.3V	1.070	0.42
FTKB0602-820MT	82 $\pm$ 20%	1k, 0.3V	1.210	0.38
FTKB0602-101MT	100 $\pm$ 20%	1k, 0.3V	1.390	0.34
FTKB0602-121MT	120 $\pm$ 20%	1k, 0.3V	1.900	0.31
FTKB0602-151MT	150 $\pm$ 20%	1k, 0.3V	2.180	0.28
FTKB0602-181MT	180 $\pm$ 20%	1k, 0.3V	2.770	0.26
FTKB0602-221MT	220 $\pm$ 20%	1k, 0.3V	3.120	0.23
FTKB0602-271MT	270 $\pm$ 20%	1k, 0.3V	4.380	0.22
FTKB0602-331MT	330 $\pm$ 20%	1k, 0.3V	4.940	0.19

## SPECIFICATIONS

### FTKB0604 TYPE

Part Number	Inductance	L Test Condition	Max. DC Resistance	Max. Rated Current
Units	μH	Hz, V	Ω	A
Symbol	L	-	DCR	I <sub>r</sub>
FTKB0604-100MT	10±20%	1k, 0.3V	0.120	1.35
FTKB0604-120MT	12±20%	1k, 0.3V	0.130	1.20
FTKB0604-150MT	15±20%	1k, 0.3V	0.180	1.10
FTKB0604-180MT	18±20%	1k, 0.3V	0.240	1.00
FTKB0604-220MT	22±20%	1k, 0.3V	0.270	0.91
FTKB0604-270MT	27±20%	1k, 0.3V	0.300	0.82
FTKB0604-330MT	33±20%	1k, 0.3V	0.330	0.75
FTKB0604-390MT	39±20%	1k, 0.3V	0.370	0.69
FTKB0604-470MT	47±20%	1k, 0.3V	0.520	0.62
FTKB0604-560MT	56±20%	1k, 0.3V	0.560	0.58
FTKB0604-680MT	68±20%	1k, 0.3V	0.630	0.52
FTKB0604-820MT	82±20%	1k, 0.3V	0.710	0.47
FTKB0604-101MT	100±20%	1k, 0.3V	1.030	0.43
FTKB0604-121MT	120±20%	1k, 0.3V	1.150	0.39
FTKB0604-151MT	150±20%	1k, 0.3V	1.680	0.35
FTKB0604-181MT	180±20%	1k, 0.3V	1.870	0.32
FTKB0604-221MT	220±20%	1k, 0.3V	2.080	0.29
FTKB0604-271MT	270±20%	1k, 0.3V	2.370	0.26
FTKB0604-331MT	330±20%	1k, 0.3V	2.670	0.23
FTKB0604-391MT	390±20%	1k, 0.3V	2.940	0.22
FTKB0604-471MT	470±20%	1k, 0.3V	3.930	0.20

### FTKB0703 TYPE

Part Number	Inductance	L Test Condition	Max. DC Resistance	Max. Rated Current
Units	μH	Hz, V	Ω	A
Symbol	L	-	DCR	I <sub>r</sub>
FTKB0703-2R2NT	2.2±30%	100k, 0.3V	0.025	3.00
FTKB0703-3R3NT	3.3±30%	100k, 0.3V	0.035	2.50
FTKB0703-4R7NT	4.7±30%	100k, 0.3V	0.031	2.00
FTKB0703-100MT	10±20%	1k, 0.3V	0.072	1.68
FTKB0703-120MT	12±20%	1k, 0.3V	0.098	1.52
FTKB0703-150MT	15±20%	1k, 0.3V	0.130	1.33
FTKB0703-180MT	18±20%	1k, 0.3V	0.140	1.20
FTKB0703-220MT	22±20%	1k, 0.3V	0.190	1.07
FTKB0703-270MT	27±20%	1k, 0.3V	0.210	0.96
FTKB0703-330MT	33±20%	1k, 0.3V	0.240	0.91
FTKB0703-390MT	39±20%	1k, 0.3V	0.320	0.77
FTKB0703-470MT	47±20%	1k, 0.3V	0.360	0.76
FTKB0703-560MT	56±20%	1k, 0.3V	0.470	0.68
FTKB0703-680MT	68±20%	1k, 0.3V	0.520	0.61
FTKB0703-820MT	82±20%	1k, 0.3V	0.690	0.57
FTKB0703-101MT	100±20%	1k, 0.3V	0.790	0.50
FTKB0703-121MT	120±20%	1k, 0.3V	0.890	0.49
FTKB0703-151MT	150±20%	1k, 0.3V	1.270	0.43
FTKB0703-181MT	180±20%	1k, 0.3V	1.450	0.39
FTKB0703-221MT	220±20%	1k, 0.3V	1.650	0.35
FTKB0703-271MT	270±20%	1k, 0.3V	2.310	0.32
FTKB0703-331MT	330±20%	1k, 0.3V	2.620	0.28
FTKB0703-391MT	390±20%	1k, 0.3V	2.940	0.26
FTKB0703-471MT	470±20%	1k, 0.3V	4.180	0.24
FTKB0703-561MT	560±20%	1k, 0.3V	4.670	0.22

## SPECIFICATIONS

### FTKB0704 TYPE

Part Number	Inductance	L Test Condition	Max. DC Resistance	Max. Rated Current
Units	$\mu\text{H}$	Hz, V	$\Omega$	A
Symbol	L	-	DCR	$I_r$
FTKB0704-100MT	10 $\pm$ 20%	1k, 0.3V	0.049	1.84
FTKB0704-120MT	12 $\pm$ 20%	1k, 0.3V	0.058	1.71
FTKB0704-150MT	15 $\pm$ 20%	1k, 0.3V	0.081	1.47
FTKB0704-180MT	18 $\pm$ 20%	1k, 0.3V	0.091	1.31
FTKB0704-220MT	22 $\pm$ 20%	1k, 0.3V	0.110	1.23
FTKB0704-270MT	27 $\pm$ 20%	1k, 0.3V	0.150	1.12
FTKB0704-330MT	33 $\pm$ 20%	1k, 0.3V	0.170	0.96
FTKB0704-390MT	39 $\pm$ 20%	1k, 0.3V	0.230	0.91
FTKB0704-470MT	47 $\pm$ 20%	1k, 0.3V	0.260	0.88
FTKB0704-560MT	56 $\pm$ 20%	1k, 0.3V	0.350	0.75
FTKB0704-680MT	68 $\pm$ 20%	1k, 0.3V	0.380	0.69
FTKB0704-820MT	82 $\pm$ 20%	1k, 0.3V	0.430	0.61
FTKB0704-101MT	100 $\pm$ 20%	1k, 0.3V	0.610	0.60
FTKB0704-121MT	120 $\pm$ 20%	1k, 0.3V	0.660	0.52
FTKB0704-151MT	150 $\pm$ 20%	1k, 0.3V	0.880	0.46
FTKB0704-181MT	180 $\pm$ 20%	1k, 0.3V	0.980	0.42
FTKB0704-221MT	220 $\pm$ 20%	1k, 0.3V	1.170	0.36
FTKB0704-271MT	270 $\pm$ 20%	1k, 0.3V	1.640	0.34
FTKB0704-331MT	330 $\pm$ 20%	1k, 0.3V	1.860	0.32
FTKB0704-391MT	390 $\pm$ 20%	1k, 0.3V	2.850	0.29
FTKB0704-471MT	470 $\pm$ 20%	1k, 0.3V	3.010	0.26
FTKB0704-561MT	560 $\pm$ 20%	1k, 0.3V	3.620	0.23

### FTKB1004 TYPE

Part Number	Inductance	L Test Condition	Max. DC Resistance	Max. Rated Current
Units	$\mu\text{H}$	Hz, V	$\Omega$	A
Symbol	L	-	DCR	$I_r$
FTKB1004-2R2NT	2.2 $\pm$ 30%	100k, 0.3V	0.018	4.00
FTKB1004-3R8NT	3.8 $\pm$ 30%	100k, 0.3V	0.028	3.50
FTKB1004-4R7NT	4.7 $\pm$ 30%	100k, 0.3V	0.035	3.20
FTKB1004-6R8NT	6.8 $\pm$ 30%	100k, 0.3V	0.044	2.80
FTKB1004-100MT	10 $\pm$ 20%	1k, 0.3V	0.050	2.40
FTKB1004-120MT	12 $\pm$ 20%	1k, 0.3V	0.054	2.25
FTKB1004-150MT	15 $\pm$ 20%	1k, 0.3V	0.061	2.00
FTKB1004-180MT	18 $\pm$ 20%	1k, 0.3V	0.084	1.80
FTKB1004-220MT	22 $\pm$ 20%	1k, 0.3V	0.094	1.65
FTKB1004-270MT	27 $\pm$ 20%	1k, 0.3V	0.110	1.45
FTKB1004-330MT	33 $\pm$ 20%	1k, 0.3V	0.150	1.35
FTKB1004-390MT	39 $\pm$ 20%	1k, 0.3V	0.170	1.20
FTKB1004-470MT	47 $\pm$ 20%	1k, 0.3V	0.210	1.10
FTKB1004-560MT	56 $\pm$ 20%	1k, 0.3V	0.230	1.00
FTKB1004-680MT	68 $\pm$ 20%	1k, 0.3V	0.260	0.93
FTKB1004-820MT	82 $\pm$ 20%	1k, 0.3V	0.360	0.84
FTKB1004-101MT	100 $\pm$ 20%	1k, 0.3V	0.410	0.76
FTKB1004-121MT	120 $\pm$ 20%	1k, 0.3V	0.450	0.70
FTKB1004-151MT	150 $\pm$ 20%	1k, 0.3V	0.640	0.63
FTKB1004-181MT	180 $\pm$ 20%	1k, 0.3V	0.840	0.57
FTKB1004-221MT	220 $\pm$ 20%	1k, 0.3V	0.960	0.52
FTKB1004-271MT	270 $\pm$ 20%	1k, 0.3V	1.070	0.47
FTKB1004-331MT	330 $\pm$ 20%	1k, 0.3V	1.370	0.43
FTKB1004-391MT	390 $\pm$ 20%	1k, 0.3V	1.550	0.39
FTKB1004-471MT	470 $\pm$ 20%	1k, 0.3V	1.740	0.36

Specifications subject to change without notice. Please check our website for latest informations.

## SPECIFICATIONS

### FTKB1204 TYPE

Part Number	Inductance	L Test Condition	Max. DC Resistance	Max. Rated Current
Units	μH	Hz, V	Ω	A
Symbol	L	-	DCR	I <sub>r</sub>
FTKB1204-1R0NT	1.0±30%	100k,0.3V	0.010	7.00
FTKB1204-2R2NT	2.2±30%	100k,0.3V	0.014	5.70
FTKB1204-3R3NT	3.3±30%	100k,0.3V	0.015	5.20
FTKB1204-4R7NT	4.7±30%	100k,0.3V	0.018	4.90
FTKB1204-5R6NT	5.6±30%	100k,0.3V	0.020	4.50
FTKB1204-6R8NT	6.8±30%	100k,0.3V	0.023	4.20
FTKB1204-8R2NT	8.2±30%	100k,0.3V	0.026	4.00
FTKB1204-100MT	10±20%	1k,0.3V	0.028	3.80
FTKB1204-120MT	12±20%	1k,0.3V	0.038	3.50
FTKB1204-150MT	15±20%	1k,0.3V	0.050	3.20
FTKB1204-180MT	18±20%	1k,0.3V	0.057	3.10
FTKB1204-220MT	22±20%	1k,0.3V	0.066	2.90
FTKB1204-270MT	27±20%	1k,0.3V	0.080	2.80
FTKB1204-330MT	33±20%	1k,0.3V	0.097	2.70
FTKB1204-390MT	39±20%	1k,0.3V	0.132	2.10
FTKB1204-470MT	47±20%	1k,0.3V	0.160	1.90
FTKB1204-560MT	56±20%	1k,0.3V	0.190	1.80
FTKB1204-680MT	68±20%	1k,0.3V	0.220	1.50
FTKB1204-820MT	82±20%	1k,0.3V	0.260	1.30
FTKB1204-101MT	100±20%	1k,0.3V	0.310	1.20
FTKB1204-121MT	120±20%	1k,0.3V	0.380	1.10
FTKB1204-151MT	150±20%	1k,0.3V	0.530	0.95
FTKB1204-181MT	180±20%	1k,0.3V	0.620	0.85
FTKB1204-221MT	220±20%	1k,0.3V	0.700	0.80
FTKB1204-271MT	270±20%	1k,0.3V	0.870	0.60
FTKB1204-331MT	330±20%	1k,0.3V	0.990	0.50
FTKB1204-471MT	470±20%	1k,0.3V	1.100	0.25

## SPECIFICATIONS

### FTKB1205 TYPE





Part Number	Inductance	L Test Condition	Max. DC Resistance	Max. Rated Current
Units	$\mu\text{H}$	Hz, V	$\Omega$	A
Symbol	L	-	DCR	$I_r$
FTKB1205-1R0NT	1.0 $\pm$ 30%	100k, 0.3V	0.010	8.00
FTKB1205-2R2NT	2.2 $\pm$ 30%	100k, 0.3V	0.014	7.80
FTKB1205-2R4NT	2.4 $\pm$ 30%	100k, 0.3V	0.014	7.50
FTKB1205-3R3NT	3.3 $\pm$ 30%	100k, 0.3V	0.014	6.80
FTKB1205-4R7NT	4.7 $\pm$ 30%	100k, 0.3V	0.020	5.60
FTKB1205-5R8NT	5.8 $\pm$ 30%	100k, 0.3V	0.020	5.20
FTKB1205-8R2NT	8.2 $\pm$ 30%	100k, 0.3V	0.021	4.40
FTKB1205-100MT	10 $\pm$ 20%	1k,0.3V	0.025	4.00
FTKB1205-120MT	12 $\pm$ 20%	1k,0.3V	0.027	3.50
FTKB1205-150MT	15 $\pm$ 20%	1k,0.3V	0.030	3.30
FTKB1205-180MT	18 $\pm$ 20%	1k,0.3V	0.034	3.00
FTKB1205-220MT	22 $\pm$ 20%	1k,0.3V	0.036	2.80
FTKB1205-270MT	27 $\pm$ 20%	1k,0.3V	0.051	2.30
FTKB1205-330MT	33 $\pm$ 20%	1k,0.3V	0.057	2.10
FTKB1205-390MT	39 $\pm$ 20%	1k,0.3V	0.068	2.00
FTKB1205-470MT	47 $\pm$ 20%	1k,0.3V	0.075	1.80
FTKB1205-560MT	56 $\pm$ 20%	1k,0.3V	0.110	1.70
FTKB1205-680MT	68 $\pm$ 20%	1k,0.3V	0.120	1.50
FTKB1205-820MT	82 $\pm$ 20%	1k,0.3V	0.140	1.40
FTKB1205-101MT	100 $\pm$ 20%	1k,0.3V	0.160	1.30
FTKB1205-121MT	120 $\pm$ 20%	1k,0.3V	0.170	1.10
FTKB1205-151MT	150 $\pm$ 20%	1k,0.3V	0.230	1.00
FTKB1205-181MT	180 $\pm$ 20%	1k,0.3V	0.290	0.90
FTKB1205-221MT	220 $\pm$ 20%	1k,0.3V	0.400	0.80
FTKB1205-271MT	270 $\pm$ 20%	1k,0.3V	0.460	0.75
FTKB1205-331MT	330 $\pm$ 20%	1k,0.3V	0.510	0.68
FTKB1205-391MT	390 $\pm$ 20%	1k,0.3V	0.690	0.65
FTKB1205-471MT	470 $\pm$ 20%	1k,0.3V	0.770	0.58
FTKB1205-561MT	560 $\pm$ 20%	1k,0.3V	0.860	0.54
FTKB1205-681MT	680 $\pm$ 20%	1k,0.3V	1.200	0.48
FTKB1205-821MT	820 $\pm$ 20%	1k,0.3V	1.340	0.43
FTKB1205-102MT	1000 $\pm$ 20%	1k,0.3V	1.800	0.40

## SPECIFICATIONS

### FTKB1207 TYPE

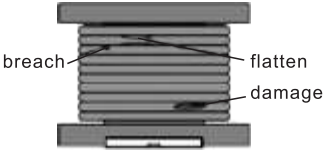
Part Number	Inductance	L Test Condition	Max. DC Resistance	Max. Rated Current
Units	$\mu\text{H}$	Hz, V	$\Omega$	A
Symbol	L	-	DCR	I <sub>r</sub>
FTKB1207-1R0NT	1.0 $\pm$ 30%	100k, 0.3V	0.009	10.00
FTKB1207-2R2NT	2.2 $\pm$ 30%	100k, 0.3V	0.012	8.00
FTKB1207-2R7NT	2.7 $\pm$ 30%	100k, 0.3V	0.013	8.00
FTKB1207-3R3NT	3.3 $\pm$ 30%	100k, 0.3V	0.013	8.00
FTKB1207-3R9NT	3.9 $\pm$ 30%	100k, 0.3V	0.013	7.50
FTKB1207-4R7NT	4.7 $\pm$ 30%	100k, 0.3V	0.016	6.80
FTKB1207-6R1NT	6.1 $\pm$ 30%	100k, 0.3V	0.018	6.60
FTKB1207-6R8NT	6.8 $\pm$ 30%	100k, 0.3V	0.019	6.60
FTKB1207-7R6NT	7.6 $\pm$ 30%	100k, 0.3V	0.020	5.90
FTKB1207-8R2NT	8.2 $\pm$ 30%	100k, 0.3V	0.020	5.60
FTKB1207-100MT	10 $\pm$ 20%	1k, 0.3V	0.021	5.40
FTKB1207-120MT	12 $\pm$ 20%	1k, 0.3V	0.024	4.90
FTKB1207-150MT	15 $\pm$ 20%	1k, 0.3V	0.027	4.50
FTKB1207-180MT	18 $\pm$ 20%	1k, 0.3V	0.039	3.90
FTKB1207-220MT	22 $\pm$ 20%	1k, 0.3V	0.043	3.60
FTKB1207-270MT	27 $\pm$ 20%	1k, 0.3V	0.046	3.40
FTKB1207-330MT	33 $\pm$ 20%	1k, 0.3V	0.065	3.00
FTKB1207-390MT	39 $\pm$ 20%	1k, 0.3V	0.073	2.75
FTKB1207-470MT	47 $\pm$ 20%	1k, 0.3V	0.100	2.50
FTKB1207-560MT	56 $\pm$ 20%	1k, 0.3V	0.110	2.35
FTKB1207-680MT	68 $\pm$ 20%	1k, 0.3V	0.140	2.10
FTKB1207-820MT	82 $\pm$ 20%	1k, 0.3V	0.160	1.95
FTKB1207-101MT	100 $\pm$ 20%	1k, 0.3V	0.220	1.70
FTKB1207-121MT	120 $\pm$ 20%	1k, 0.3V	0.250	1.60
FTKB1207-151MT	150 $\pm$ 20%	1k, 0.3V	0.280	1.42
FTKB1207-181MT	180 $\pm$ 20%	1k, 0.3V	0.350	1.30
FTKB1207-221MT	220 $\pm$ 20%	1k, 0.3V	0.390	1.16
FTKB1207-271MT	270 $\pm$ 20%	1k, 0.3V	0.560	1.06
FTKB1207-331MT	330 $\pm$ 20%	1k, 0.3V	0.640	0.95
FTKB1207-391MT	390 $\pm$ 20%	1k, 0.3V	0.700	0.88
FTKB1207-471MT	470 $\pm$ 20%	1k, 0.3V	0.980	0.79
FTKB1207-561MT	560 $\pm$ 20%	1k, 0.3V	1.070	0.73
FTKB1207-681MT	680 $\pm$ 20%	1k, 0.3V	1.460	0.67
FTKB1207-821MT	820 $\pm$ 20%	1k, 0.3V	1.640	0.60
FTKB1207-102MT	1000 $\pm$ 20%	1k, 0.3V	1.820	0.55

**VISUAL INSPECTION STANDARD OF PRODUCT**

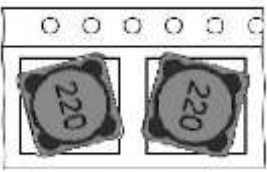
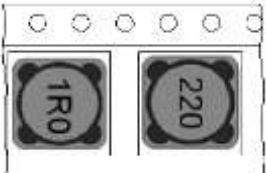
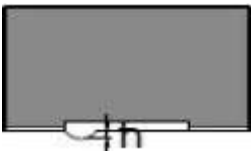
File No:		Applied to Wire Wound SMD Power Inductor Series	
Effective date:			
No.	Defect Item	Graphic	Rejection identification
1	Line damage		Enamelled copper wire ( with the exception of a solder joint ), injury, crushing, bending deformation, or other causes of copper wire bare, reduced cross sectional area defects
2	Wire fracture		Enamelled copper wire fracture
3	Printing defects		Printing defect, can not be correctly identified
4	Core chipping		(1)length $l \geq 1/8$ Upper swing diameter or depth $\geq 1/5$ Placed on the thickness (2)width $d \geq 1/10$ Upper swing diameter or depth $\geq 1/5$ Placed on the thickness
5	Tape card feeding		Products in the carrier tape to shake
6	Mixed material		Different models of product mix
7	Electrode uneven		Single or two electrodes is localized in the same plane, height difference $h > 0.1\text{mm}$