

8	7	6	5	4	3	2	1		
NO.							REV.	DRAW	DATE
1							A0	廖振纲	20200728
2									

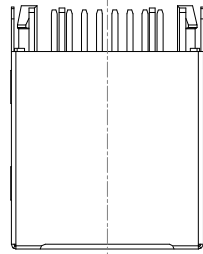

TOP VIEW

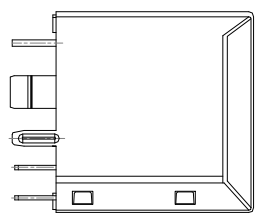

LEFT SIDE VIEW

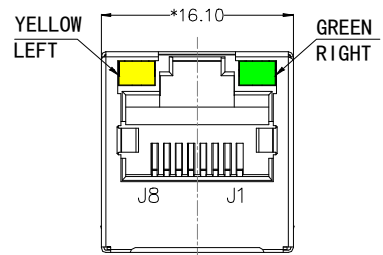

FRONT VIEW

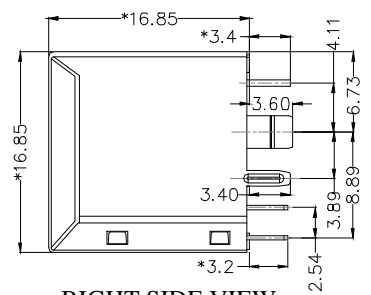

RIGHT SIDE VIEW

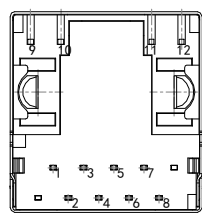

BACK VIEW

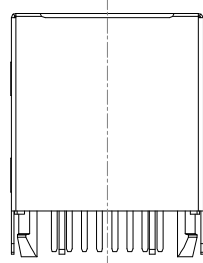

BOTTOM VIEW

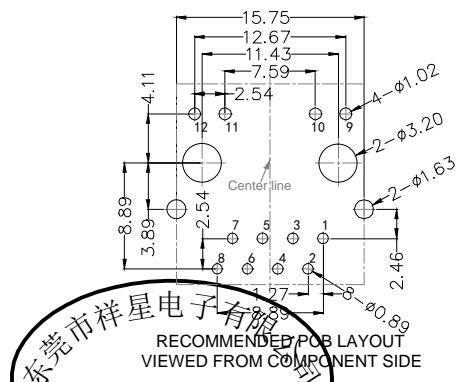

东莞市祥星电子有限公司
工程专用章

MATERIAL:

HOUSING: PBT,UL94V-0,BLACK.
 TERMINALS BRACKET: PBT,UL94V-0,BLACK.
 SHIELD: C2680,T=0.20MM,NICKEL PLATING ON ALL AREA.
 TERMINAL: PHOSPHOR BRONZE C5210,T=0.35MM,
 6U" GOLD PLATING ON CONTACT AREA.

MECHANICAL:

DURABILITY: 750 CYCLES MIN.
 MATING FORCE: 23N MAX.
 OPERATING TEMPERATURE: -40°C~+85°C.
 STORAGE TEMPERATURE: -40°C~+85°C.
 ALL CRITICAL DIMENSIONS WITH "*"

未注公差 TOLERANCE UNLESS OTHERWISE SPECIFIED				E-NETTR 东莞市祥星电子有限公司 DONGGUANG XIANGXING ELECTRONICS CO., LTD			
				Miss yang:13694998066 Mr Li:15013501940 TEL:0769-86384669 FAX:0769-81813600 Http://www.e-nettr.com xxing.guang@163.com			
比例 SCALE		角法 PROJ.		设计 DESIGN		品号 ITEM NO.	300501
张数 SHEET	1/3	纸张 SIZE	A4	校对 CHECK		品名 TITLE	GR01M1HXA001
单位 UNIT	mm	版本 REV.	A0	核准 APPROVAL		规格 DESC.	

NO.	ECN NO.	DESCRIPTION	REV.	DRAW	DATE
1		新版发行	A0	廖振纲	20200728
2					

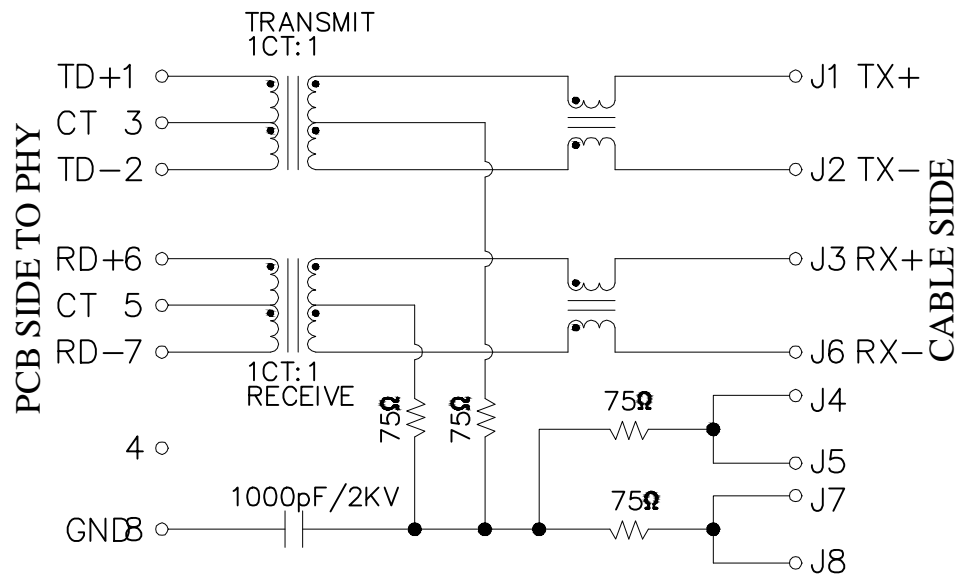

Electrical:

- Turn ratio: 1~2: J1~J2=1CT:1CT(±2%).
6~7: J3~J6=1CT:1CT(±2%).
- OCL: 350uH Min. at 100KHz 100mV 8mA DC.
- Insertion Loss: -1.0 dB Max 1~100MHz.
- Return loss: -20dB Min 1~10MHz;
-16dB Min 10~30MHz;
-12dB Min 30~60MHz;
-10dB Min 60~80MHz.
- Cross talk: -40dB Min 1~30MHz;
-35dB Min 30~60MHz;
-30dB Min 60~100MHz;
- CMR: -30dB Min 1~100MHz;
- Hi-Pot: 1500V AC & 2250V DC
6S 1mA PRI TO SEC

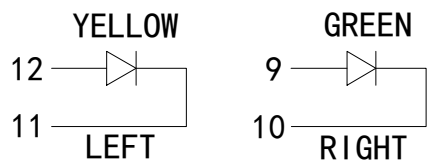

LED Specification

Standard LED Color	LED Wavelength	Foward(A)	Foward(V)
Green	568nm	20mA	1.85-2.45V
Yellow	585nm	20mA	1.7-2.2V



未注公差 TOLERANCE UNLESS OTHERWISE SPECIFIED				E-NETTR 东莞市祥星电子有限公司 DONGGUANG XIANGXING ELECTRONICS CO., LTD Miss yang:13694998066 Mr Li:15013501940 TEL:0769-86384669 FAX:0769-81813600 Http://www.e-nettr.com xxing.guang@163.com			
比例 SCALE		角法 PROJ.	⊕	设计 DESIGN		品号 ITEM NO.	300501
张数 SHEET	2/3	纸张 SIZE	A4	校对 CHECK		品名 TITLE	GR01M1HXA001
单位 UNIT	mm	版本 REV.	A0	核准 APPROVAL		规格 DESC.	

NO.	ECN NO.	DESCRIPTION	REV.	DRAW	DATE
1		新版发行	A0	廖振纲	20200728
2					

PROFILE OF WAVE SOLDER

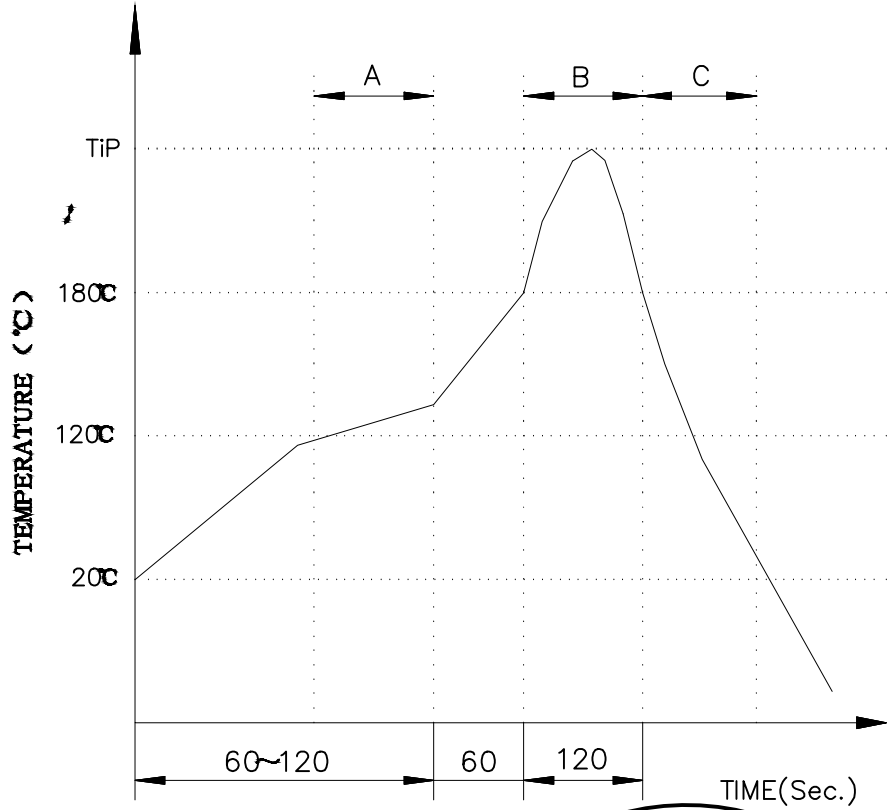

A.Preheating B.Soldering C.Gradual Cooling
 Tip temperature:260±5°C.
 Tip temperature time:5Sec Max.
 Tip melting point of Sn96.5/Ag3/Cu0.5:217°C.

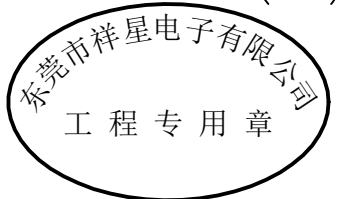

Remarks: after wave soldering, the plastic positioning columns of the product which under the PCB will be slightly melted, but it won't affect its function.

未注公差 TOLERANCE UNLESS OTHERWISE SPECIFIED				E-NETTR 东莞市祥星电子有限公司 DONGGUANG XIANGXING ELECTRONICS CO., LTD			
				Miss yang:13694998066 Mr Li:15013501940 TEL:0769-86384669 FAX:0769-81813600 Http://www.e-nettr.com xxing.guang@163.com			
比例 SCALE		角法 PROJ.	设计 DESIGN	品号 ITEM NO.	300501		
张数 SHEET	3/3	纸张 SIZE	A4	校对 CHECK	品名 TITLE		GR01M1HXA001
单位 UNIT	mm	版本 REV.	A0	核准 APPROVAL	规格 DESC.		