

120V N-Channel Enhancement Mode MOSFET

Description

The AP200N12P/T uses advanced **APM-SGT₁** technology to provide excellent $R_{DS(ON)}$, low gate charge and operation with gate voltages as low as 10V. This device is suitable for use as a Battery protection or in other Switching application.

General Features

$V_{DS} = 120V$ (Type: **135V**) $I_D = 200A$

$R_{DS(ON)} < 4.2m\Omega$ @ $V_{GS}=10V$ (Type: **3.7m\Omega**)

Application

BMS

UPS

Power Management Switches

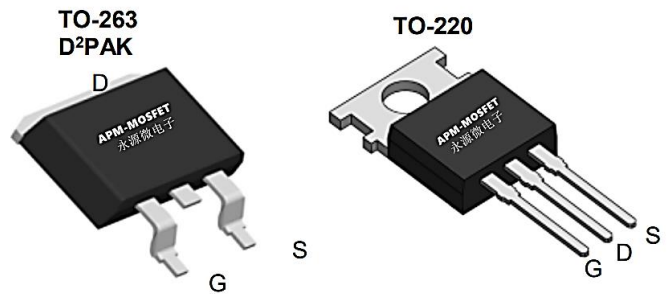
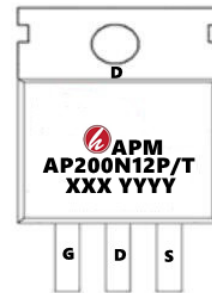
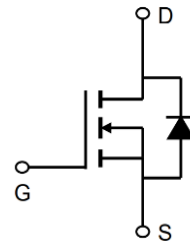

Package Marking and Ordering Information

Product ID	Pack	Marking	Qty(PCS)
AP200N12P	TO-220-3L	AP200N12P XXX YYYY	1000
AP200N12T	TO-263-3L	AP200N12T XXX YYYY	800

Absolute Maximum Ratings ($T_C=25^\circ\text{C}$ unless otherwise noted)

Symbol	Parameter	Rating	Units
V_{DS}	Drain-Source Voltage	120	V
V_{GS}	Gate-Source Voltage	± 20	V
$I_D@T_C=25^\circ\text{C}$	Continuous Drain Current, $V_{GS} @ 10V$	200	A
$I_D@T_C=100^\circ\text{C}$	Continuous Drain Current, $V_{GS} @ 10V$	150	A
IDM	Pulsed Drain Current	600	A
EAS	Single Pulse Avalanche Energy	530	mJ
IAS	Avalanche Current	45	A
$P_D@T_C=25^\circ\text{C}$	Total Power Dissipation ⁴	240	W
TSTG	Storage Temperature Range	-55 to 150	$^\circ\text{C}$
T_J	Operating Junction Temperature Range	-55 to 150	$^\circ\text{C}$
$R_{\theta JA}$	Thermal Resistance Junction-Ambient	0.75	$^\circ\text{C/W}$
$R_{\theta JC}$	Thermal Resistance Junction-Case	62	$^\circ\text{C/W}$



120V N-Channel Enhancement Mode MOSFET

Electrical Characteristics (T_c=25°C unless otherwise noted)

Symbol	Parameter	Test Conditions	Min.	Type	Max.	Unit
VDSS	Drain-Source Breakdown Voltage	V _{GS} = 0V, I _D = 250μA	120	135	-	V
IGSS	Gate-body Leakage current	V _{DS} = 0V, V _{GS} = ±20V	-	-	±100	nA
IDSS	Zero Gate Voltage Drain Current T _J =25°C	V _{DS} = 120V, V _{GS} = 0V	-	-	1	μA
IDSS	Zero Gate Voltage Drain Current T _J =100°C		-	-	100	
VGS(th)	Gate-Threshold Voltage	V _{DS} = V _{GS} , I _D = 250μA	2.0	2.9	4.0	V
RDS(on)	Drain-Source on-Resistance ²	V _{GS} = 10V, I _D = 20A	-	3.7	4.2	mΩ
RDS(on)	Drain-Source on-Resistance ²	V _{GS} = 6V, I _D = 20A	-	4.3	5.8	mΩ
Ciss	Input Capacitance	V _{GS} = 0V, V _{DS} = 60V, f = 250kHz	-	5240	-	pF
Coss	Output Capacitance		-	739	-	
Crss	Reverse Transfer Capacitance		-	12	-	
R _g	Gate Resistance	V _{GS} = 0V, V _{DS} = 0V, f = 1MHz	-	1.7	-	Ω
Q _g	Total Gate Charge	V _{DD} = 60V, I _D = 45A, V _{GS} = 0 to 10V	-	19	-	nC
Q _{gs}	Gate-Source Charge		-	11	-	
Q _{gd}	Gate-Drain Charge		-	75	-	
td(on)	Turn-on Delay Time	V _{DD} = 60V, V _{GS} = 10V, I _D = 45A, R _G = 10Ω	-	59	-	ns
t _r	Rise Time		-	41	-	
td(off)	Turn-off Delay Time		-	96	-	
t _f	Fall Time		-	33	-	
VSD	Diode Forward Voltage ²	I _F = 20A, V _{GS} = 0V	-	0.8	1.2	V
I _S	Continuous Source Current ^{1,5}	V _G = V _D = 0V, Force Current	-	-	200	A
trr	Body Diode Reverse Recovery Time	V _R = 60V I _F = 35A, di/dt = 100A/μs	-	70	-	ns
Q _{rr}	Body Diode Reverse Recovery Charge		-	200	-	nC

Notes:

- 1、 The data tested by surface mounted on a 1 inch² FR-4 board with 2OZ copper.
- 2、 The data tested by pulsed , pulse width ≤ 300us , duty cycle ≤ 2%
- 3、 The EAS data shows Max. rating . The test condition is V_{DD}=50V, V_{GS}=10V, L=0.5mH, I_{AS}=45A
- 4、 The power dissipation is limited by 150°C junction temperature
- 5、 The data is theoretically the same as I_D and I_{DM} , in real applications , should be limited by total power dissipation.

Typical Characteristics

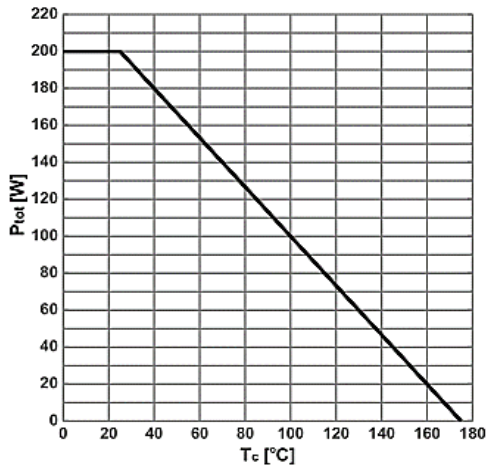

Figure 1. Power dissipation

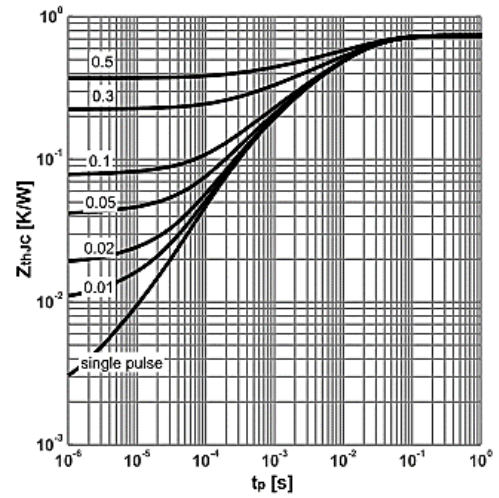

Figure 2. Max. transient thermal impedance

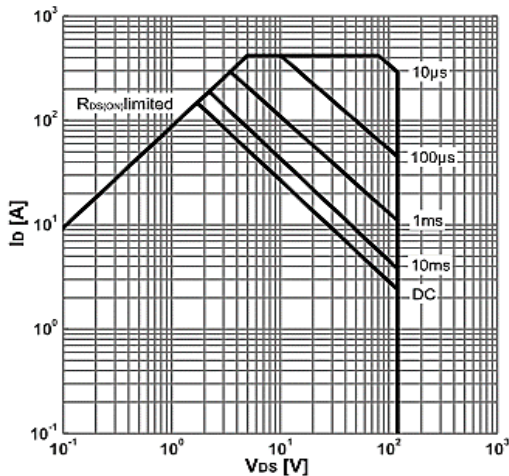

Figure 3. Safe operating area

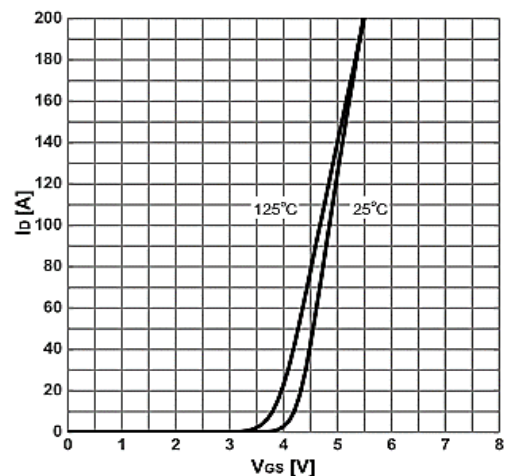

Figure 4. Iype. transfer characteristics

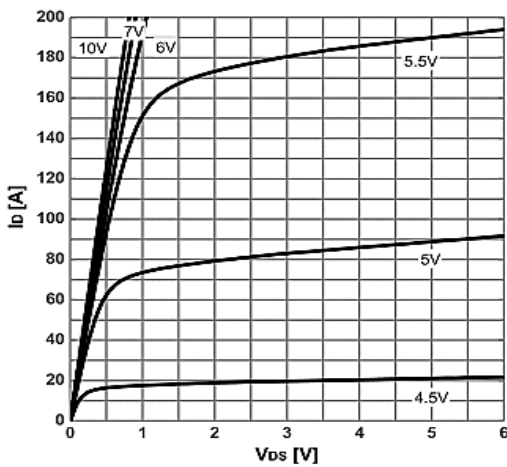

Figure 5. Typ. output characteristics(T_j 25°C)

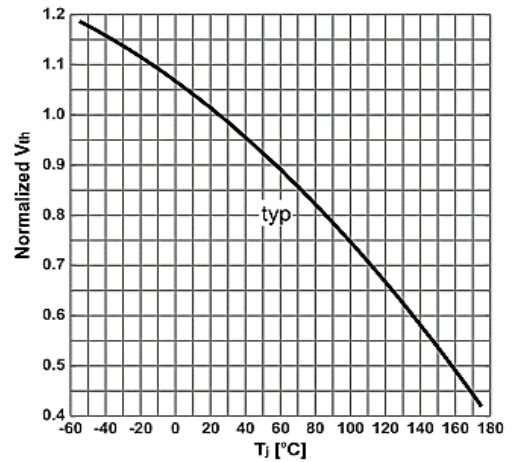

Figure 6. Typ. output characteristics(T_j 125°C)

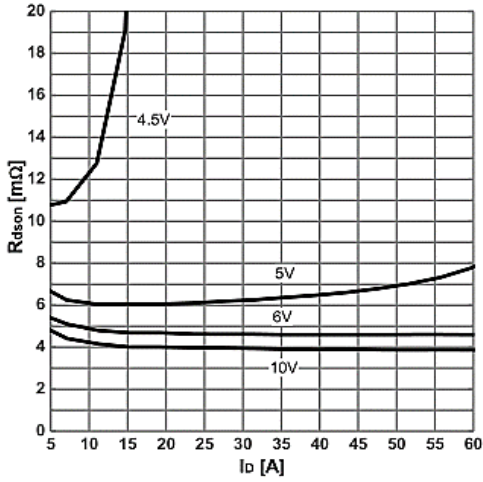

Figure 7. On-state resistance vs. Drain current

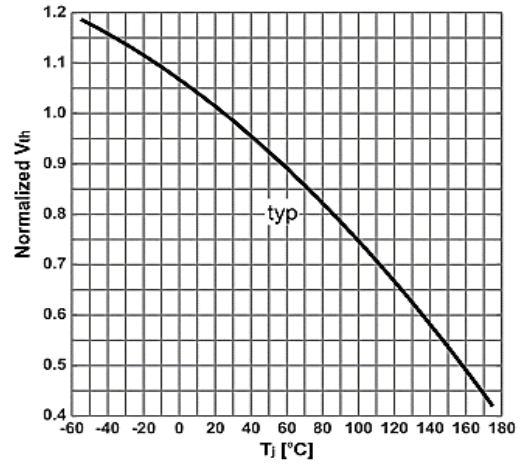

Figure 6. Gate threshold voltage vs. Junction Temperature

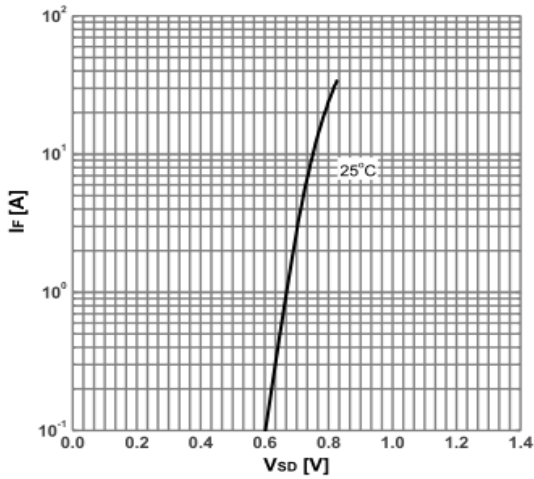

Figure 9. Forward characteristics of reverse diode

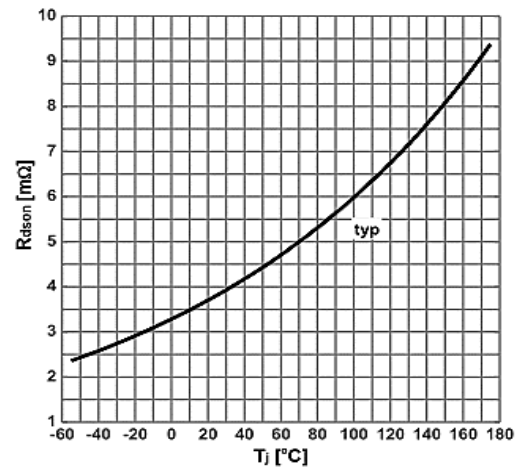

Figure 8. On-state resistance vs. Junction temperature

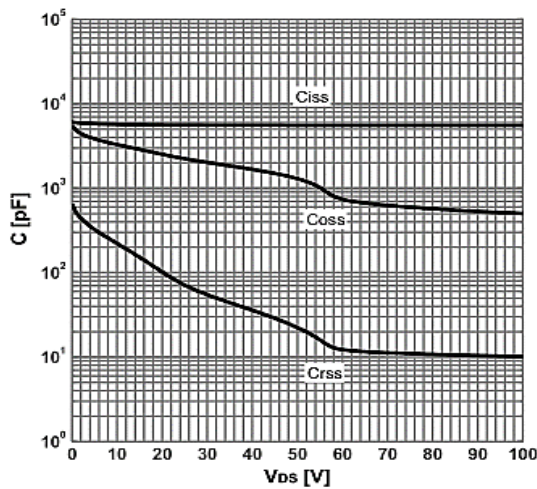

Figure9 Typ. capacitances

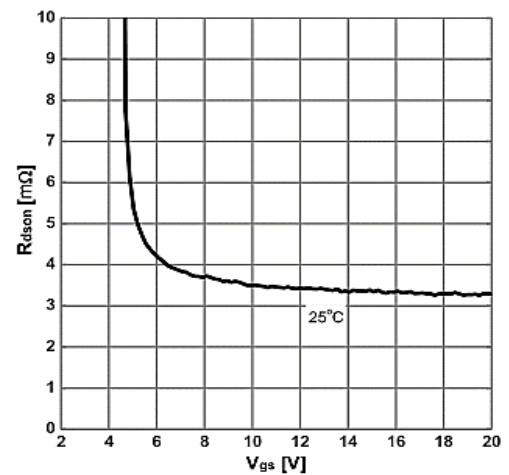

Figure11. On-state resistance vs. Vgs characteristics

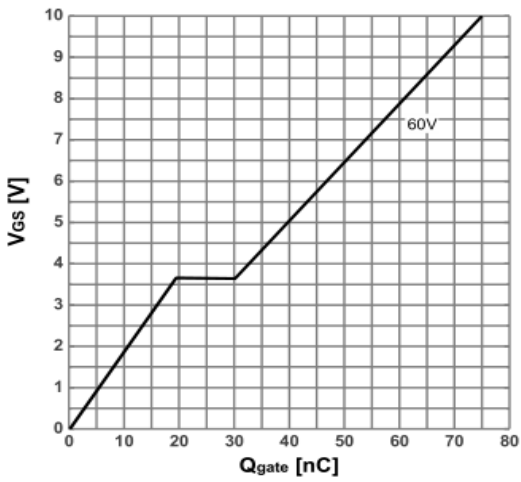
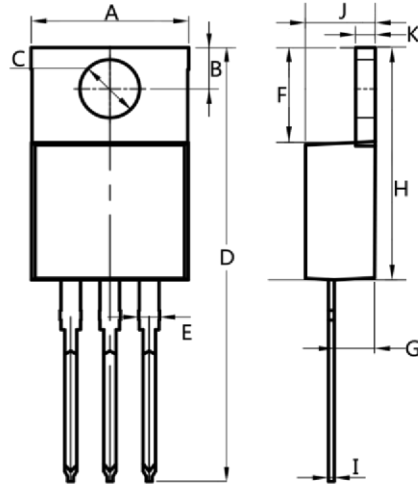

Figure 13: Typ. gate charge

120V N-Channel Enhancement Mode MOSFET

TO-220AB



Dim.	Min.	Max.
A	10.0	10.4
B	2.5	3.0
C	3.5	4.0
D	28.0	30.0
E	1.1	1.5
F	6.2	6.6
G	2.9	3.3
H	15.0	16.0
I	0.35	0.45
J	4.3	4.7
K	1.2	1.4
All Dimensions in millimeter		

ITO-220AB

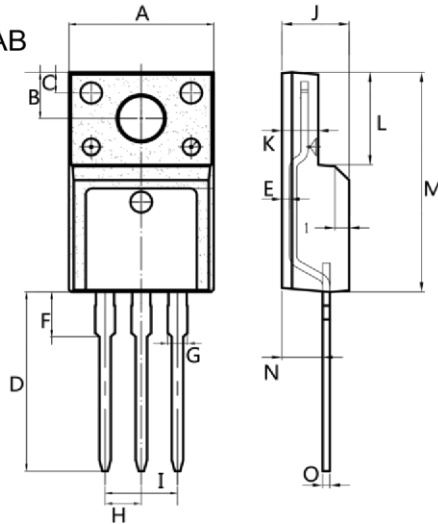

Dim.	Min.	Max.
A	9.9	10.3
B	2.9	3.5
C	1.15	1.45
D	12.75	13.25
E	0.55	0.75
F	3.1	3.5
G	1.25	1.45
H	Typ 2.54	
I	Typ 5.08	
J	4.55	4.75
K	2.4	2.7
L	6.35	6.75
M	15.0	16.0
N	2.75	3.15
O	0.45	0.60
All Dimensions in millimeter		

TO-263

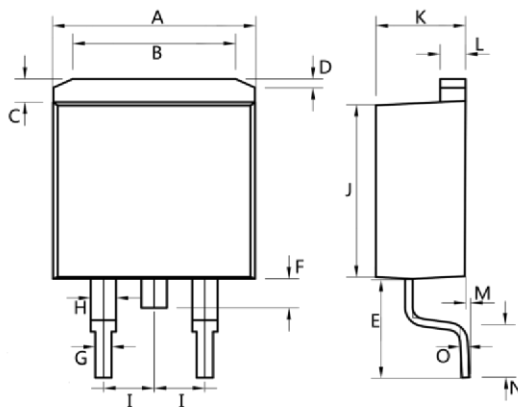

Dim.	Min.	Max.
A	10.0	10.5
B	7.25	7.75
C	1.3	1.5
D	0.55	0.75
E	5.0	6.0
F	1.4	1.6
G	0.75	0.95
H	1.15	1.35
I	Typ 2.54	
J	8.4	8.6
K	4.4	4.6
L	1.25	1.45
M	0.02	0.1
N	2.4	2.8
O	0.35	0.45
All Dimensions in millimeter		

120V N-Channel Enhancement Mode MOSFET**Attention**

1, Any and all APM Microelectronics products described or contained herein do not have specifications that can handle applications that require extremely high levels of reliability, such as life support systems, aircraft's control systems, or other applications whose failure can be reasonably expected to result in serious physical and/or material damage. Consult with your APM Microelectronics representative nearest you before using any APM Microelectronics products described or contained herein in such applications.

2, APM Microelectronics assumes no responsibility for equipment failures that result from using products at values that exceed, even momentarily, rated values (such as maximum ratings, operating condition ranges, or other parameters) listed in products specifications of any and all APM Microelectronics products described or contained herein.

3, Specifications of any and all APM Microelectronics products described or contained here instipulate the performance, characteristics, and functions of the described products in the independent state, and are not guarantees of the performance, characteristics, and functions of the described products as mounted in the customer's products or equipment. To verify symptoms and states that cannot be evaluated in an independent device, the customer should always evaluate and test devices mounted in the customer's products or equipment.

4, APM Microelectronics Semiconductor CO., LTD. strives to supply high quality high reliability products. However, any and all semiconductor products fail with some probability. It is possible that these probabilistic failures could give rise to accidents or events that could endanger human lives that could give rise to smoke or fire, or that could cause damage to other property. When designing equipment, adopt safety measures so that these kinds of accidents or events cannot occur. Such measures include but are not limited to protective circuits and error prevention circuits for safe design, redundant design, and structural design.

5, In the event that any or all APM Microelectronics products (including technical data, services) described or contained herein are controlled under any of applicable local export control laws and regulations, such products must not be exported without obtaining the export license from the authorities concerned in accordance with the above law.

6, No part of this publication may be reproduced or transmitted in any form or by any means, electronic or mechanical, including photocopying and recording, or any information storage or retrieval system, or otherwise, without the prior written permission of APM Microelectronics Semiconductor CO., LTD.

7, Information (including circuit diagrams and circuit parameters) herein is for example only; it is not guaranteed for volume production. APM Microelectronics believes information herein is accurate and reliable, but no guarantees are made or implied regarding its use or any infringements of intellectual property rights or other rights of third parties.

8, Any and all information described or contained herein are subject to change without notice due to product/technology improvement, etc. When designing equipment, refer to the "Delivery Specification" for the APM Microelectronics product that you intend to use.



Edition	Date	Change
Rve1.0	2021/8/5	Initial release

Copyright Attribution“APM-Microelectronice”