

Features

- 20μA Ground Current at no Load
- ±2% Output Accuracy
- 300mA Output Current
- Wide Operating Input Voltage Range:1.2V to 5.5V
- SOT-23 SOT89-3 Package Available

General Description

The TPRT9166 series set of low power high voltage regulators implemented in CMOS technology which can provide 300mA output current. The device allows input voltage as high as 5.5V. The TPRT9166 series is available in several fixed output voltages. CMOS technology ensures low dropout voltage and low quiescent current.

Although designed primarily as fixed voltage regulators, the device can be used with external components to obtain variable output voltages.

Applications

- Portable, Battery Powered Equipment
- Low Power Microcontrollers
- Laptop, Palmtops and PDAs
- Wireless Communication Equipment

Ordering Information

TPRT9166-33GVL

GXL:SOT89-3Package
GVL:SOT23 Package

Output voltage: 12=1.2V
15=1.5V
18=1.8V
30=3.0V
33=3.3V
50=5.0V

Marking Information

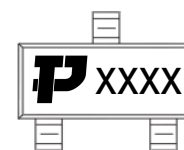

P : Logo
XXX: Marking ID

PIN CONFIGURATION

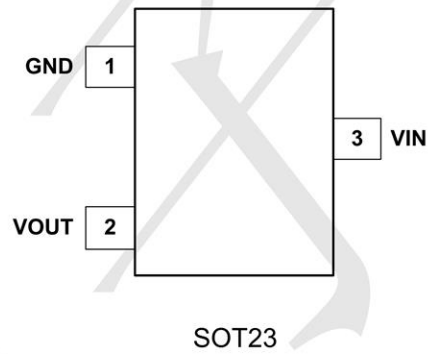
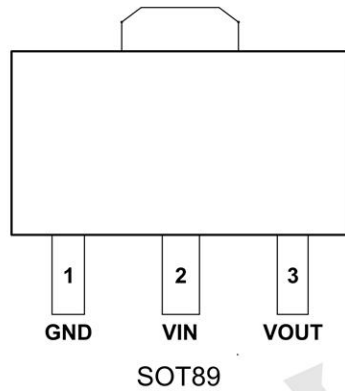

Pin Name	Pin Function
VIN	Power Input Voltage
GND	Ground
OUT	Output Voltage

Typical Application Circuit

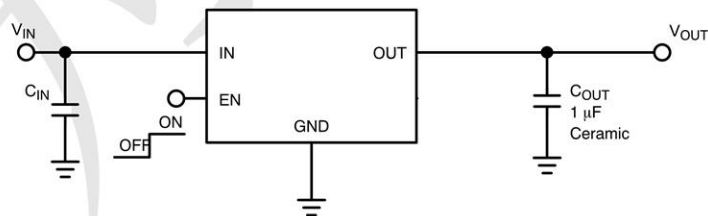

BLOCK DIAGRAM

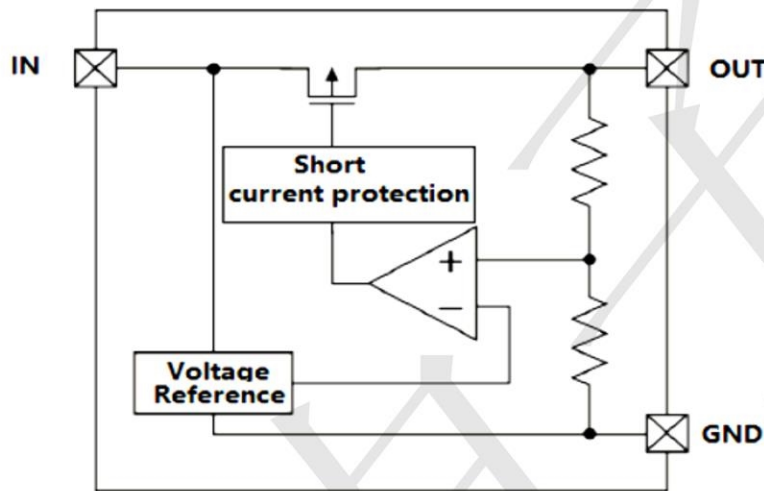

Absolute Maximum Ratings

Rating	Symbol	Value	Unit
Input Voltage (Note 1)	V_{IN}	-0.3 V to 6 V	V
Output Voltage	V_{OUT}	-0.3 V to $V_{IN} + 0.3$ V or 6 V	V
Enable Input	V_{EN}	-0.3 V to 6 V	V
Output Short Circuit Duration	t _{SC}	∞	s
Maximum Junction Temperature	$T_{J(MAX)}$	150	°C
Storage Temperature	T_{STG}	-55 to 150	°C
ESD Capability, Human Body Model (Note 2)	ESD _{HBM}	2000	V
ESD Capability, Machine Model (Note 2)	ESD _{MM}	200	V

SOT-23-3 0.4W
 Package Thermal Resistance
 SOT-23-3, θ_{JA} 250°C/W

Electrical Characteristics

Parameter	Test Conditions	Symbol	Min	Typ	Max	Unit		
Operating Input Voltage		V_{IN}	1.2		5.5	V		
Output Voltage Accuracy	$-40^{\circ}\text{C} \leq T_J \leq 85^{\circ}\text{C}$	$V_{OUT} \leq 2.0\text{ V}$	V_{OUT}	-40		+40	mV	
		$V_{OUT} > 2.0\text{ V}$		-2		+2	%	
Dropout Voltage – TSOP package (Note 5)	$I_{OUT} = 300\text{ mA}$	$V_{OUT} = 1.5\text{ V}$		380		485	mV	
		$V_{OUT} = 1.85\text{ V}$		260		355		
		$V_{OUT} = 2.8\text{ V}$	V_{DO}		170			255
		$V_{OUT} = 3.0\text{ V}$			160			245
		$V_{OUT} = 3.1\text{ V}$			155			235
		$V_{OUT} = 3.3\text{ V}$			150			225
Output Current Limit	$V_{OUT} = 90\% V_{OUT(nom)}$	I_{CL}	300	600		mA		
Ground Current	$I_{OUT} = 0\text{ mA}$	I_Q			20	μA		
Shutdown Current	$V_{EN} \leq 0.4\text{ V}, V_{IN} = 5.5\text{ V}$	I_{DIS}		0.01	1	μA		
EN Pin Threshold Voltage High Threshold Low Threshold	V_{EN} Voltage increasing V_{EN} Voltage decreasing	V_{EN_HI} V_{EN_LO}	0.6		2	V		
Power Supply Rejection Ratio	$V_{IN} = 3.6\text{ V}, V_{OUT} = 3.1\text{ V}$ $I_{OUT} = 150\text{ mA}$ $f = 1\text{ kHz}$	PSRR		75		dB		
Output Noise Voltage	$V_{IN} = 2.5\text{ V}, V_{OUT} = 1.8\text{ V}, I_{OUT} = 150\text{ mA}$ $f = 10\text{ Hz to } 100\text{ kHz}$	V_N		70		μV_{rms}		
Thermal Shutdown Temperature	Temperature increasing from $T_J = +25^{\circ}\text{C}$	T_{SD}		160		$^{\circ}\text{C}$		
Thermal Shutdown Hysteresis	Temperature falling from T_{SD}	T_{SDH}		10		$^{\circ}\text{C}$		
Active Output Discharge Resistance	$V_{EN} < 0.4\text{ V}$, Version A only	R_{DIS}		100		Ω		



TECH PUBLIC

—台丹电子—

TPRT9166 Series

300mA,20uA, CMOS LDO Regulator

www.sot23.com.tw

Package information

SOT89-3

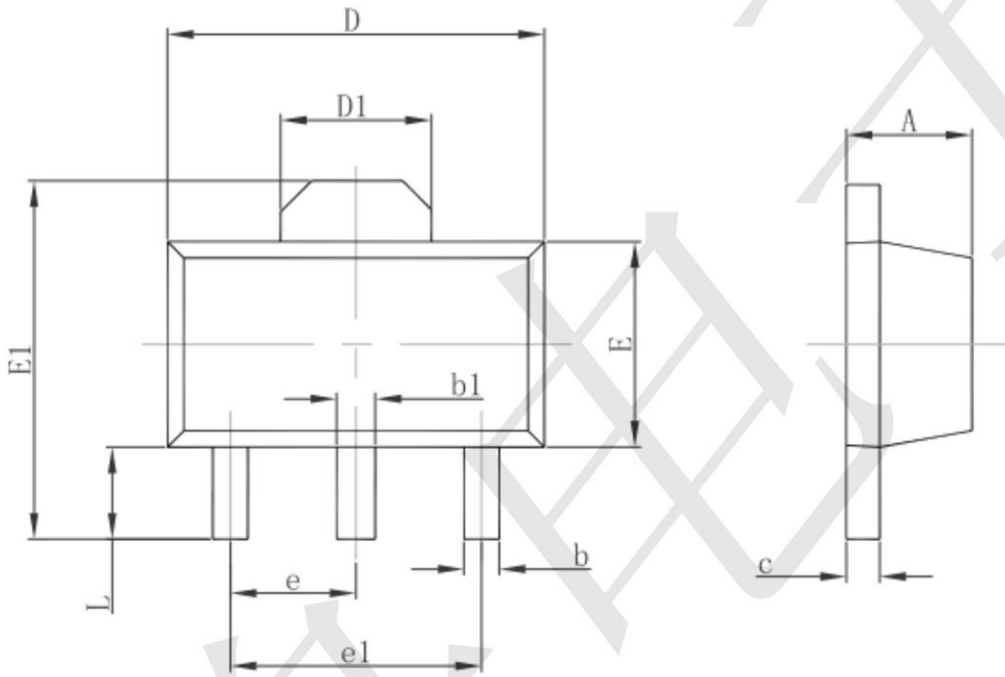

Symbol	Dimensions In Millimeters		Dimensions In Inches	
	Min.	Max.	Min.	Max.
A	1.400	1.600	0.055	0.063
b	0.320	0.520	0.013	0.020
b1	0.400	0.580	0.016	0.023
c	0.350	0.440	0.014	0.017
D	4.400	4.600	0.173	0.181
D1	1.550 REF.		0.061 REF.	
E	2.300	2.600	0.091	0.102
E1	3.940	4.250	0.155	0.167
e	1.500 TYP.		0.060 TYP.	
e1	3.000 TYP.		0.118 TYP.	
L	0.900	1.200	0.035	0.047



TECH PUBLIC

—台丹电子—

TPRT9166 Series

300mA,20uA, CMOS LDO Regulator

www.sot23.com.tw

Package information

SOT23-3L

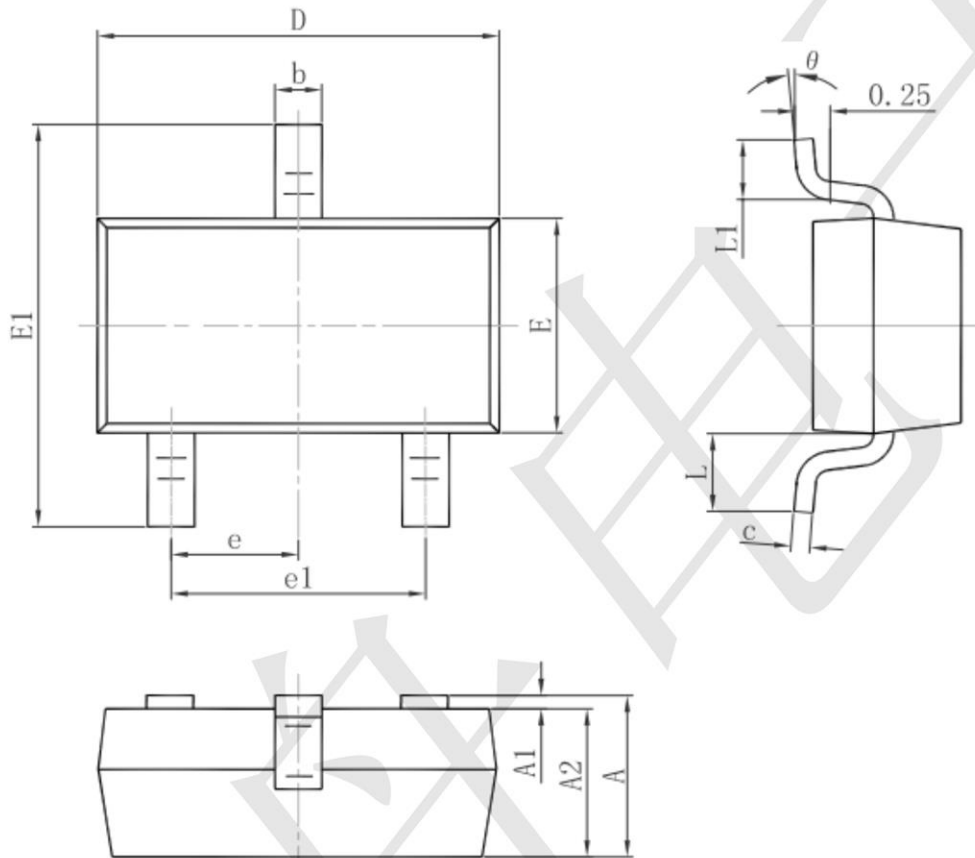

Symbol	Dimensions In Millimeters		Dimensions In Inches	
	Min.	Max.	Min.	Max.
A	0.900	1.150	0.035	0.045
A1	0.000	0.100	0.000	0.004
A2	0.900	1.050	0.035	0.041
b	0.300	0.500	0.012	0.020
c	0.080	0.150	0.003	0.006
D	2.800	3.000	0.110	0.118
E	1.200	1.400	0.047	0.055
E1	2.250	2.550	0.089	0.100
e	0.950 TYP.		0.037 TYP.	
e1	1.800	2.000	0.071	0.079
L	0.550 REF.		0.022 REF.	
L1	0.300	0.500	0.012	0.020
theta	0°	8°	0°	8°