

## N-Channel Enhancement Mode MOSFET

### Description

The HX3400B uses advanced trench technology to provide excellent  $R_{DS(ON)}$ , low gate charge and high density cell Design for ultra low on-resistance. This device is suitable for use as a load switch or in PWM applications.

### General Features

- ◆  $V_{DS} = 30V$ ,  $I_D = 5.8A$   
 $R_{DS(ON)}(Typ.) = 24m\Omega$  @  $V_{GS} = 4.5V$   
 $R_{DS(ON)}(Typ.) = 35m\Omega$  @  $V_{GS} = 2.5V$
- ◆ High power and current handling capability
- ◆ Lead free product is acquired
- ◆ Surface mount package

### Application

- ◆ PWM applications
- ◆ Load switch

### Package

- ◆ SOT-23-3L



### Schematic diagram

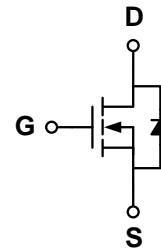

### pin assignment

SOT-23-3L  
(TOP VIEW)

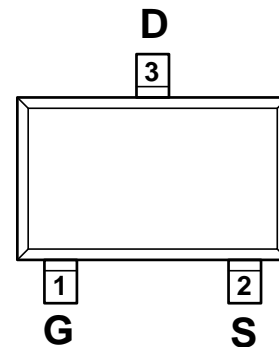

### Ordering Information

Part Number	Storage Temperature	Package	Devices Per Reel
HX3400B	-55°C to +150°C	SOT-23-3L	3000

NOTE: HX3400B : B It stands for SOT-23-3L

### Absolute Maximum Ratings (TA=25°C unless otherwise noted)

parameter	symbol	limit	unit
Drain-source voltage	$V_{DS}$	30	V
Gate-source voltage	$V_{GS}$	±12	V
Drain current-continuous <sup>a</sup> @ $T_j = 125^\circ C$ -pulse <sup>b</sup>	$I_D$	5.8	A
	$I_{DM}$	30	A
Drain-source Diode forward current	$I_S$	2	A
Maximum power dissipation	$P_D$	1.4	W
Operating junction Temperature range	$T_j$	-55—150	°C

**Electrical Characteristics** (TA=25°C unless otherwise noted)

Parameter	Symbol	Condition	Min	Typ	Max	Unit
<b>OFF Characteristics</b>						
Drain-source breakdown voltage	$BV_{DSS}$	$V_{GS}=0V, I_D=250\mu A$	30	-	-	V
Zero gate voltage drain current	$I_{DSS}$	$V_{DS}=30V, V_{GS}=0V$	-	-	1	$\mu A$
Gate-body leakage	$I_{GSS}$	$V_{DS}=0V, V_{GS}=\pm 12V$	-	-	$\pm 100$	nA
<b>ON Characteristics</b>						
Gate threshold voltage	$V_{GS(th)}$	$V_{DS}=V_{GS}, I_D=250\mu A$	0.45	0.62	0.85	V
Drain-source on-state resistance	$R_{DS(ON)}$	$V_{GS}=4.5V, I_D=5A$	-	24	35	m $\Omega$
		$V_{GS}=2.5V, I_D=4A$	-	35	45	
Forward transconductance	$g_{fs}$	$V_{GS}=5V, I_D=5.8A$	-	33	-	S
<b>Dynamic Characteristics</b>						
Input capacitance	$C_{ISS}$	$V_{DS}=15V, V_{GS}=0V$ $f=1.0MHz$	-	473	-	pF
Output capacitance	$C_{OSS}$		-	57	-	
Reverse transfer capacitance	$C_{RSS}$		-	43	-	
<b>Switching Characteristics</b>						
Turn-on delay time	$t_{D(ON)}$	$V_{DS}=15V$ $V_{GS}=10V$ $R_L=2.6\ ohm$ $R_{GEN}=3ohm$	-	3	-	ns
Rise time	$t_r$		-	2.5	-	
Turn-off delay time	$t_{D(OFF)}$		-	25	-	
Fall time	$t_f$		-	4	-	
Total gate charge	$Q_g$	$V_{DS}=15V, I_D=5A$ $V_{GS}=4.5V$	-	5.6	-	nC
Gate-source charge	$Q_{gs}$		-	1.1	-	
Gate-drain charge	$Q_{gd}$		-	1.2	-	
<b>DRAIN-SOURCE DIODE CHARACTERISTICS</b>						
Diode forward voltage	$V_{SD}$	$V_{GS}=0V, I_s=1A$	-	0.76	1.16	V

**Notes:**

- surface mounted on FR4 board,  $t \leq 10sec$
- pulse test: pulse width  $\leq 300\mu s$ , duty  $\leq 2\%$
- guaranteed by design, not subject to production testing

**Thermal Characteristics**

Thermal Resistance junction-to ambient	$R_{th\ JA}$	100	$^{\circ}C/W$
--	--------------	-----	---------------

### Typical Performance Characteristics

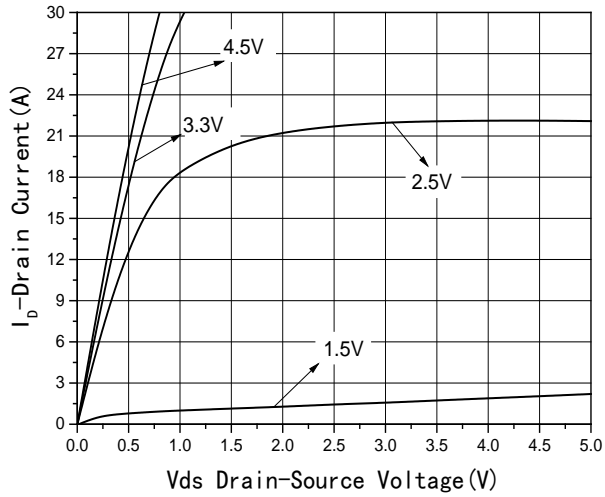

**Fig1 Output Characteristics**

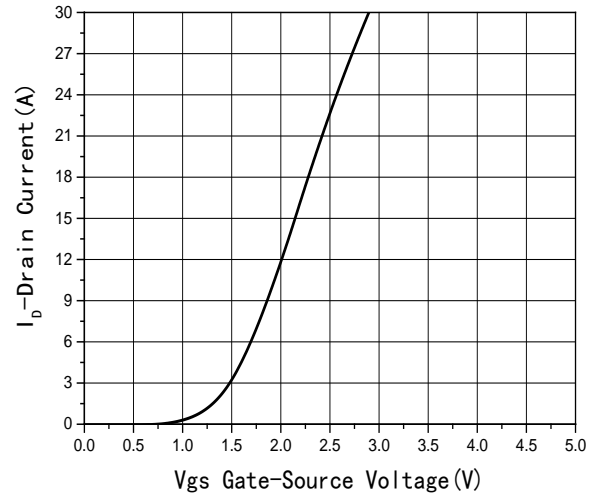

**Fig2 Transfer Characteristics**

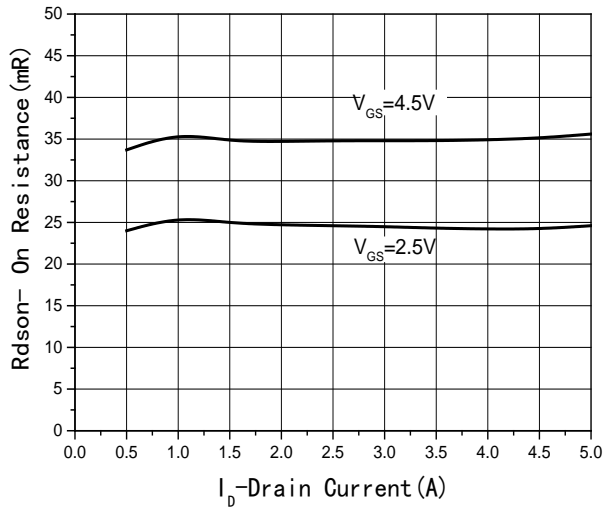

**Fig3  $R_{DS(on)}$ -Drain current**

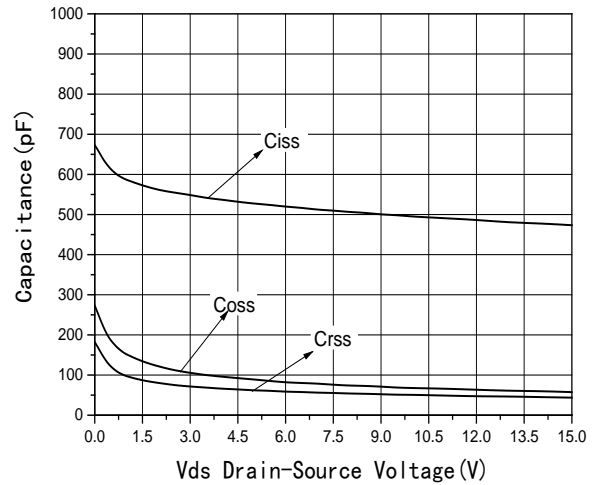

**Fig4 Capacitance vs  $V_{DS}$**

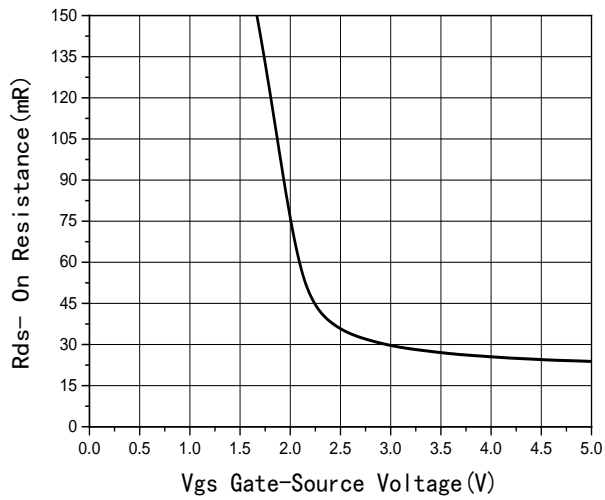

**Fig5  $R_{DS(on)}$ -Gate Drain voltage**

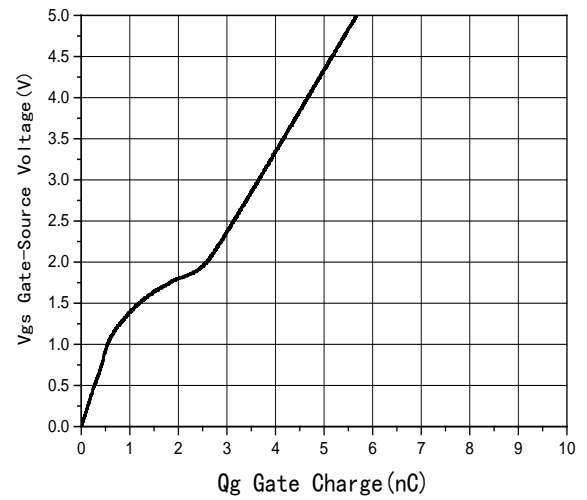

**Fig6 Gate Charge**

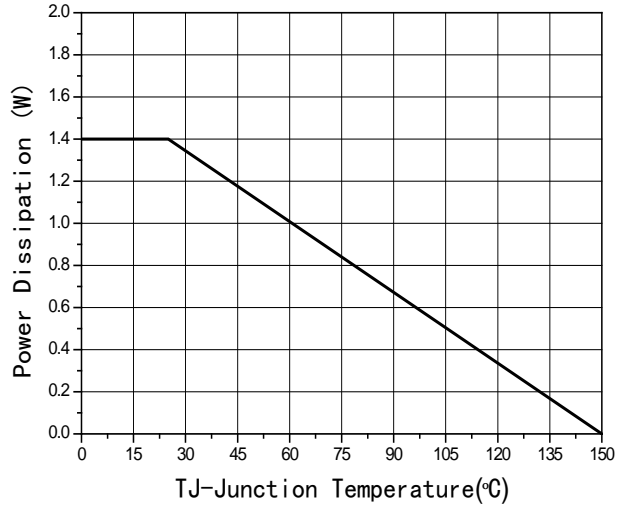

**Fig7 Power De-rating**

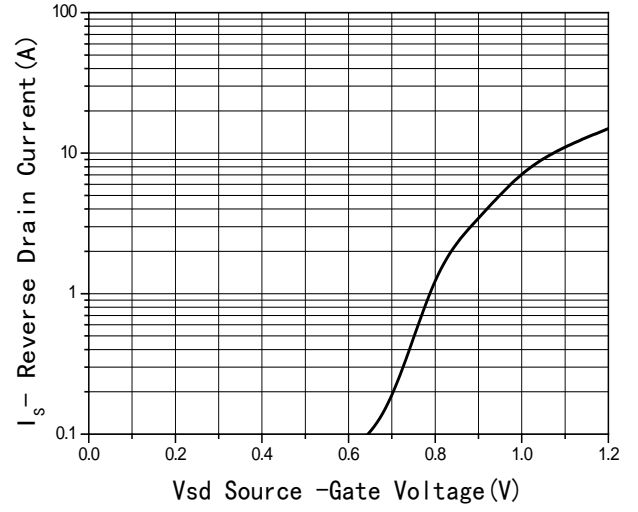

**Fig8 Source-Drain Diode Forward**

Package Information

- SOT-23-3L

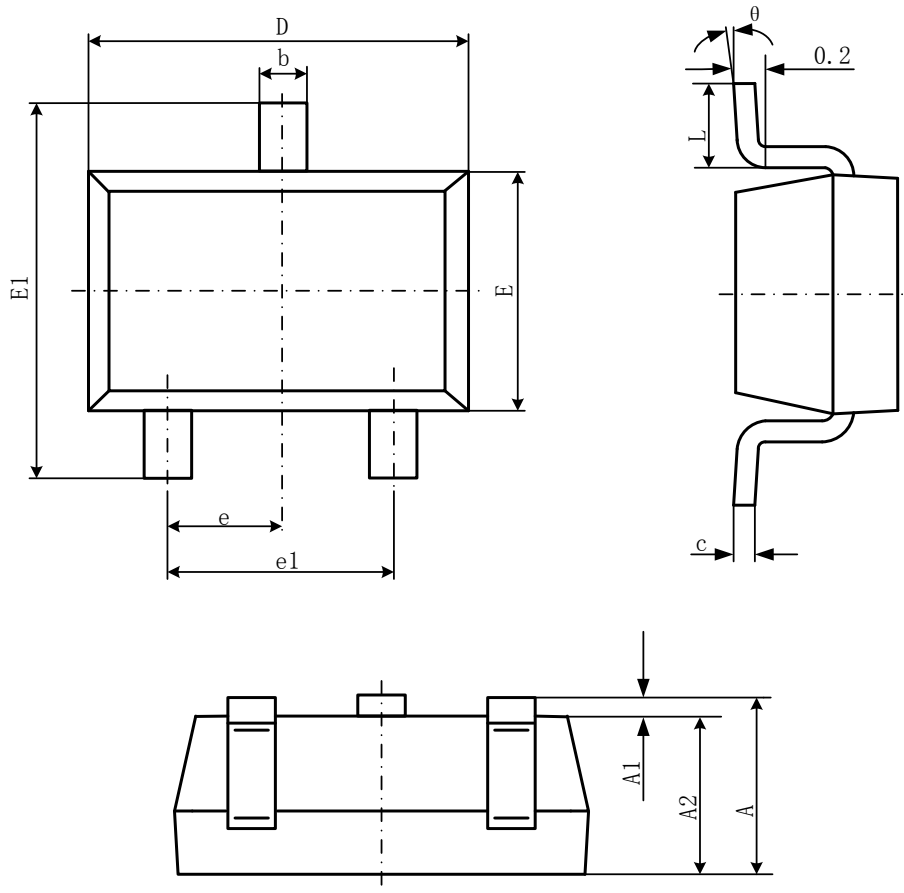

Symbol	Dimensions In Millimeters		Dimensions In Inches	
	Min	Max	Min	Max
A	1.050	1.250	0.041	0.049
A1	0.000	0.100	0.000	0.004
A2	1.050	1.150	0.041	0.045
b	0.300	0.500	0.012	0.020
c	0.100	0.200	0.004	0.008
D	2.820	3.020	0.111	0.119
E	1.500	1.700	0.059	0.067
E1	2.650	2.950	0.104	0.116
e	0.950(BSC)		0.037(BSC)	
e1	1.800	2.000	0.071	0.079
L	0.300	0.600	0.012	0.024
θ	0°	8°	0°	8°