

### FEATURES

- High breakdown voltage to 1200V for improved reliability
- Trench-Stop Technology offering :
  - Very tight parameter distribution
  - High ruggedness, temperature stable behavior
  - Short circuit withstand time – 10μs
  - Low  $V_{CE(SAT)}$
  - Easy parallel switching capability due to positive temperature coefficient in  $V_{CE(SAT)}$
- Enhanced avalanche capability

$V_{CE}$	1200	V
$I_C$	25	A
$V_{CE(SAT)} I_C=25A$	1.65	V

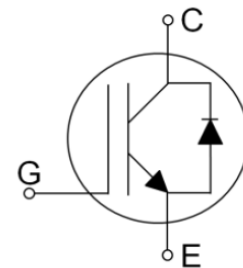

### APPLICATION

- Frequency Converters
- Motor Drive

Product	Package	Packaging
YGW25N120T1	TO247	Tube

**Maximum Ratings**

Parameter	Symbol	Value	Unit
Collector-Emitter Breakdown Voltage	$V_{CE}$	1200	V
DC collector current, limited by $T_{jmax}$ $T_C = 25^\circ\text{C}$ $T_C = 100^\circ\text{C}$	$I_C$	50 25	A
Diode Forward current, limited by $T_{jmax}$ $T_C = 25^\circ\text{C}$ $T_C = 100^\circ\text{C}$	$I_F$	50 25	A
Continuous Gate-emitter voltage	$V_{GE}$	$\pm 20$	V
Transient Gate-emitter voltage	$V_{GE}$	$\pm 30$	V
Turn off safe operating area $V_{CE} \leq 1200\text{V}$ , $T_j \leq 150^\circ\text{C}$	-	100	A
Pulsed collector current, $V_{GE} = 15\text{V}$ , $t_p$ limited by $T_{jmax}$	$I_{CM}$	100	A
Short Circuit Withstand Time, $V_{GE} = 15\text{V}$ , $V_{CE} \leq 600\text{V}$	$T_{sc}$	10	$\mu\text{s}$
Power dissipation , $T_j = 25^\circ\text{C}$	$P_{tot}$	250	W
Operating junction temperature	$T_j$	-40...+150	$^\circ\text{C}$
Storage temperature	$T_s$	-55...+150	$^\circ\text{C}$
Soldering temperature, wave soldering 1.6mm (0.063in.) from case for 10s	-	260	$^\circ\text{C}$

**Thermal Resistance**

Parameter	Symbol	Max. Value	Unit
IGBT thermal resistance, junction - case	$R_{\theta(j-c)}$	0.5	K/W
Diode thermal resistance, junction - case	$R_{\theta(j-c)}$	1	K/W
Thermal resistance, junction - ambient	$R_{\theta(j-a)}$	40	K/W

**Electrical Characteristics of the IGBT** ( $T_j = 25^\circ\text{C}$  unless otherwise specified) :

Parameter	Symbol	Conditions	Min	Typ	Max	Unit
<b>Static</b>						
Collector-Emitter breakdown voltage	$BV_{CES}$	$V_{GE}=0V, I_C=250\mu A$	1200	-	-	V
Gate threshold voltage	$V_{GE(th)}$	$V_{GE}=V_{CE}, I_C=250\mu A$	5.2	6.0	6.8	V
Collector-Emitter Saturation voltage	$V_{CE(sat)}$	$V_{GE}=15V, I_C=25A$ $T_j = 25^\circ\text{C}$ $T_j = 150^\circ\text{C}$	- -	1.65 2.0	2.05 -	V
Zero gate voltage collector current	$I_{CES}$	$V_{CE} = 1200V, V_{GE} = 0V$ $T_j = 25^\circ\text{C}$ $T_j = 150^\circ\text{C}$	- -	- -	100 1000	$\mu A$
Gate-emitter leakage current	$I_{GES}$	$V_{CE} = 0V, V_{GE} = \pm 20V$	-	-	100	nA
Transconductance	$g_{fs}$	$V_{CE}=20V, I_C=20A$	-	20	-	S

Parameter	Symbol	Conditions	Min	Typ	Max	Unit
<b>Dynamic</b>						
Input capacitance	$C_{ies}$	$V_{CE} = 25V, V_{GE} = 0V,$ $f = 1\text{MHz}$	-	2340	-	pF
Output capacitance	$C_{oes}$		-	105	-	
Reverse transfer capacitance	$C_{res}$		-	60	-	
Gate charge	$Q_G$	$V_{CC} = 960V, I_C = 25A,$ $V_{GE} = 15V$	-	135	-	nC
Short circuit collector current	$I_{C(SC)}$	$V_{GE}=15V, t_{SC} \leq 10\mu s$ $V_{CC}=600V,$ $T_{j, start}=25^\circ\text{C}$	-	210	-	A

**Switching Characteristic, Inductive Load**

Parameter	Symbol	Conditions	Min	Typ	Max	Unit
<b>Dynamic , at <math>T_j = 25^\circ \text{C}</math></b>						
Turn-on delay time	$t_{d(on)}$	$V_{CC} = 600\text{V}, I_C = 25\text{A},$ $V_{GE} = 0/15\text{V},$ $R_g = 12\Omega$	-	45	-	ns
Rise time	$t_r$		-	21	-	ns
Turn-on energy	$E_{on}$		-	2.2	-	mJ
Turn-off delay time	$t_{d(off)}$		-	200	-	ns
Fall time	$t_f$		-	93	-	ns
Turn-off energy	$E_{off}$		-	0.75	-	mJ

**Electrical Characteristics of the DIODE** ( $T_j = 25^\circ \text{C}$  unless otherwise specified)

Parameter	Symbol	Conditions	Min	Typ	Max	Unit
<b>Dynamic</b>						
Diode Forward Voltage	$V_{FM}$	$I_F = 25\text{A}$	-	3.0	-	V
Reverse Recovery Time	$T_{rr}$	$I_F = 25\text{A},$ $di/dt = 200\text{A}/\mu\text{s}$	-	180	-	ns
Reverse Recovery Current	$I_{rr}$		-	5	-	A
Reverse Recovery Charge	$Q_{rr}$		-	270	-	nC

Fig. 1 FBSOA characteristics

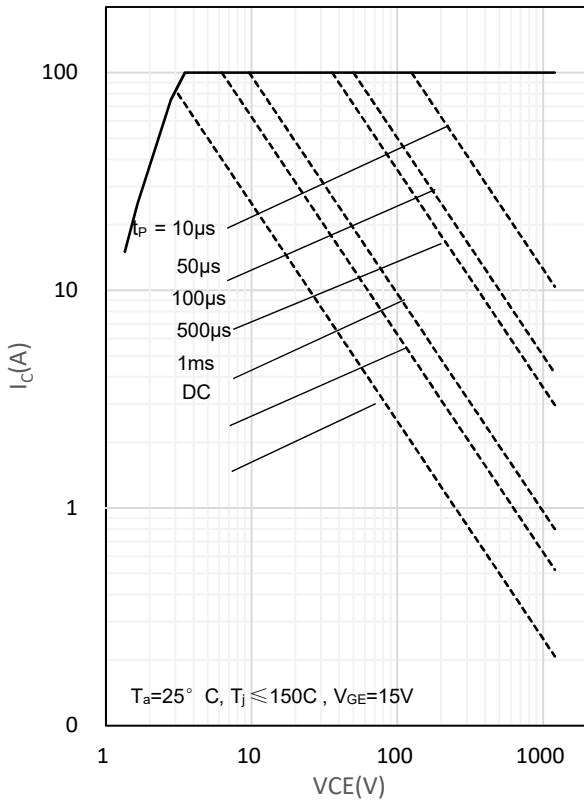

Fig. 2 Load Current vs. Frequency

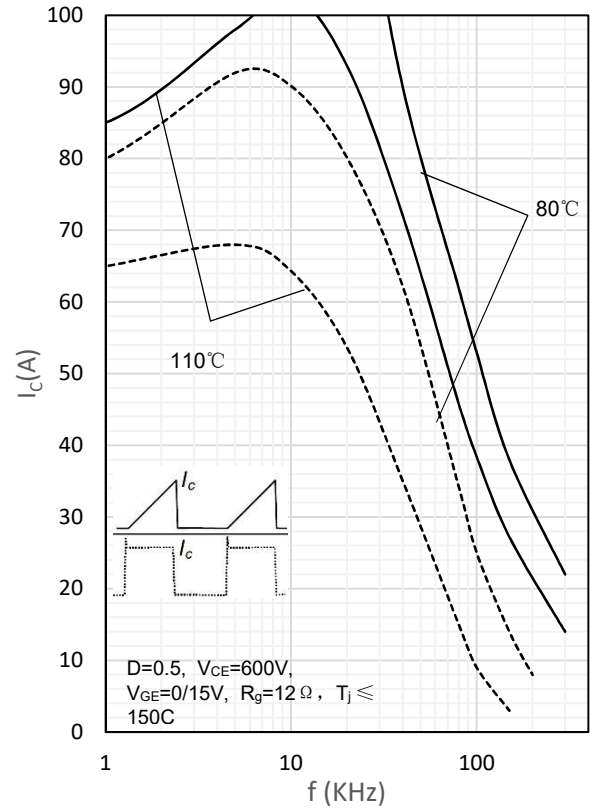

Fig. 3 Output characteristics

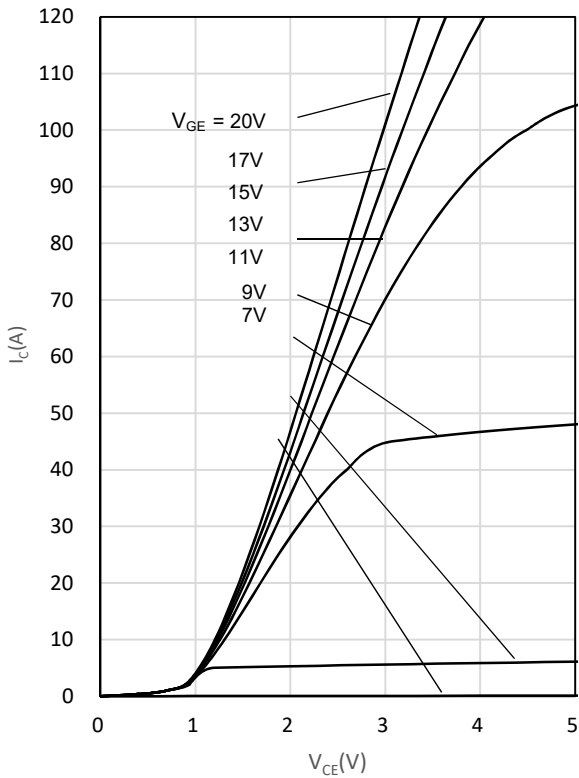

Fig. 4 Saturation voltage characteristics

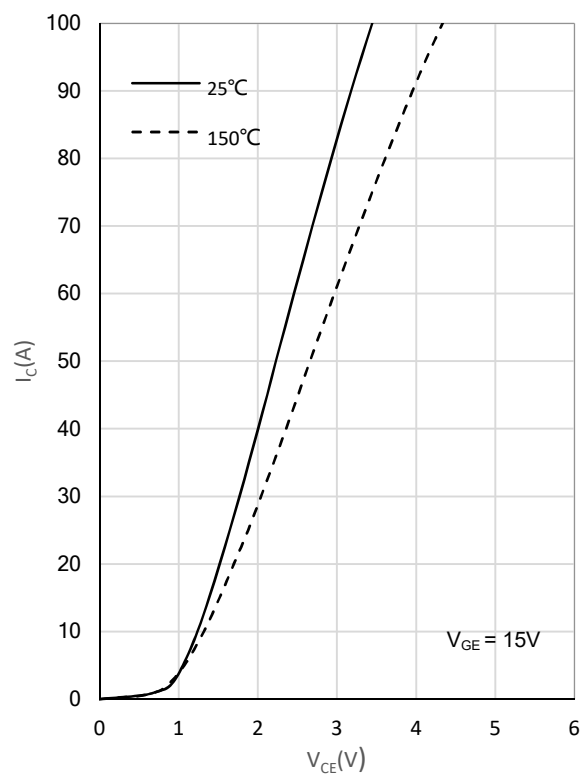

Fig. 5 Switching times vs. gate resistor

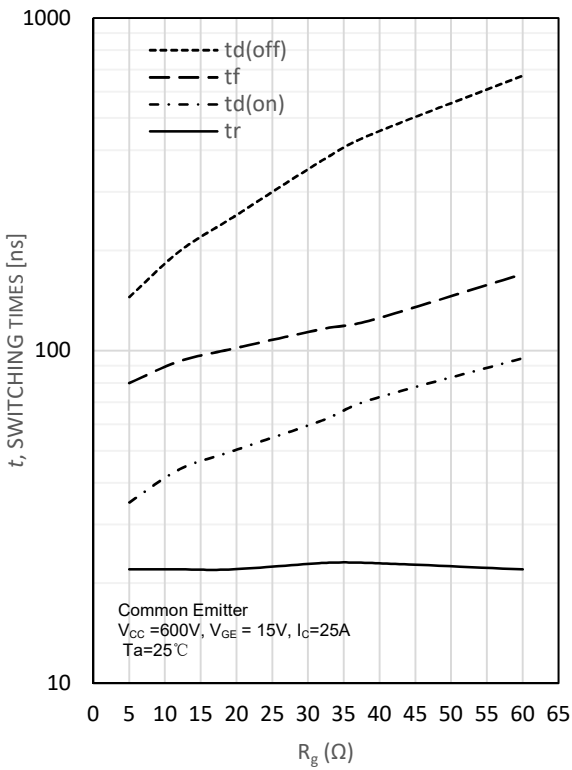

Fig. 6 Switching times vs. collector current

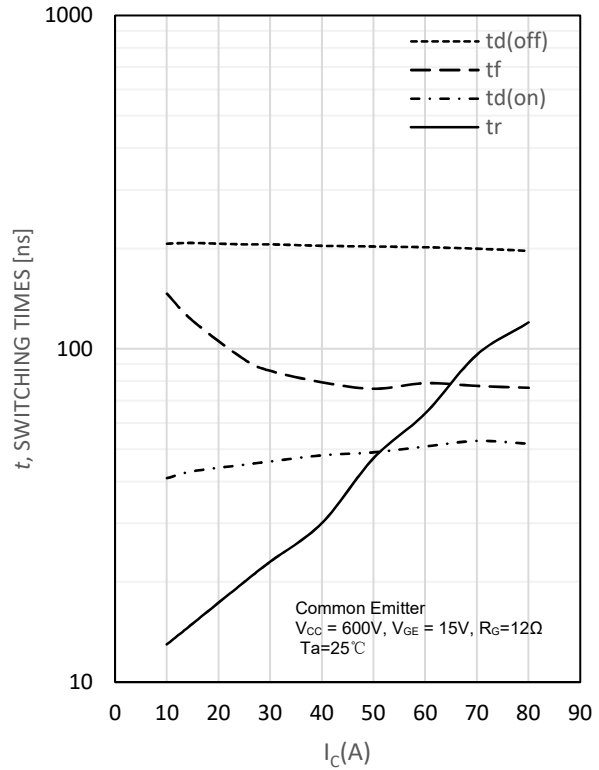

Fig. 7 Switching loss vs. gate resistor

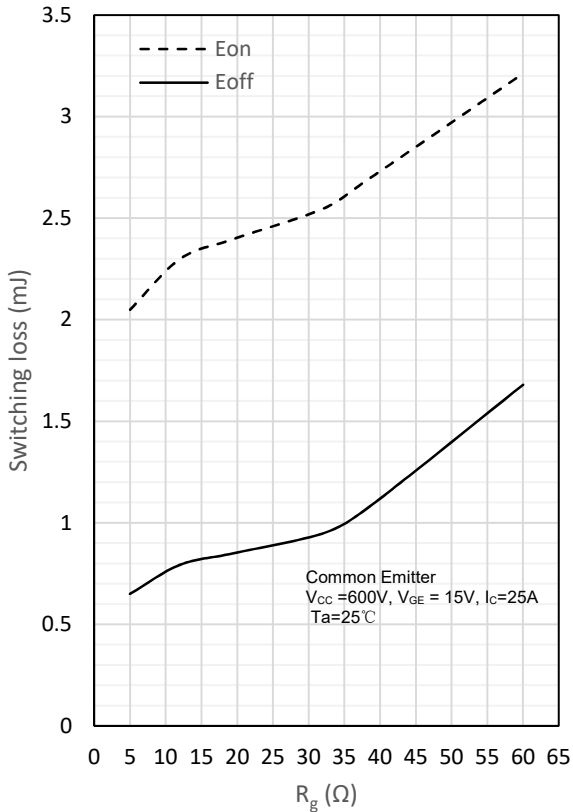

Fig. 8 Switching loss vs. collector current

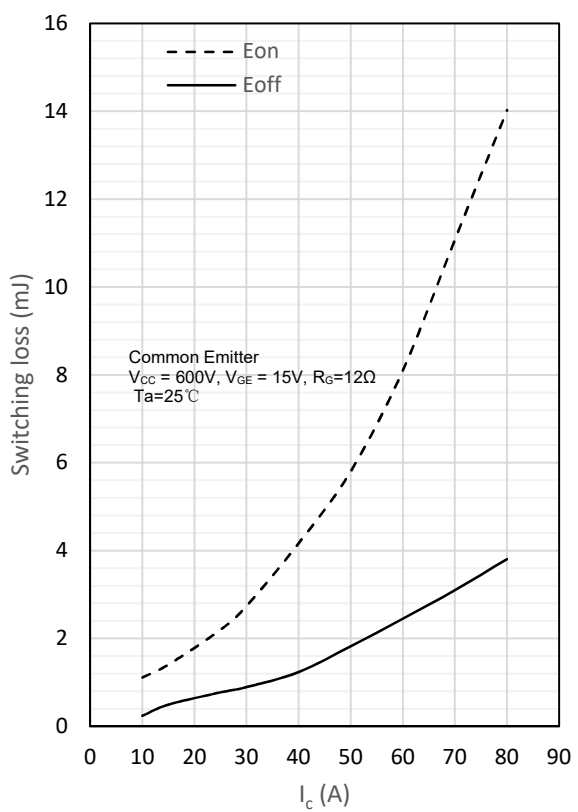

Fig. 9 Gate charge characteristics

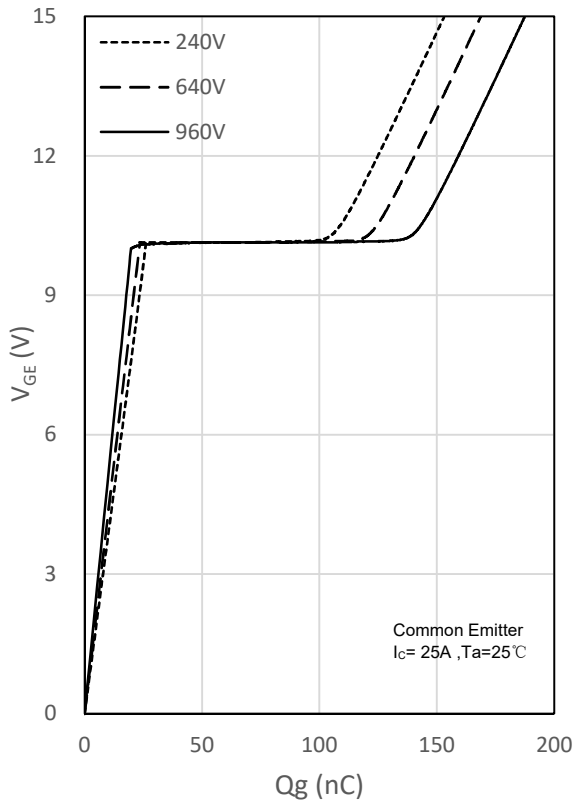
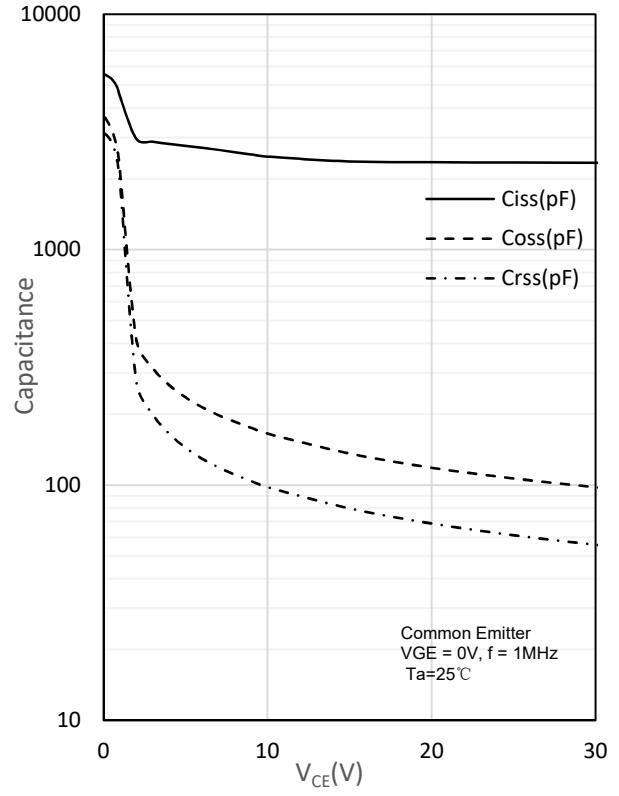
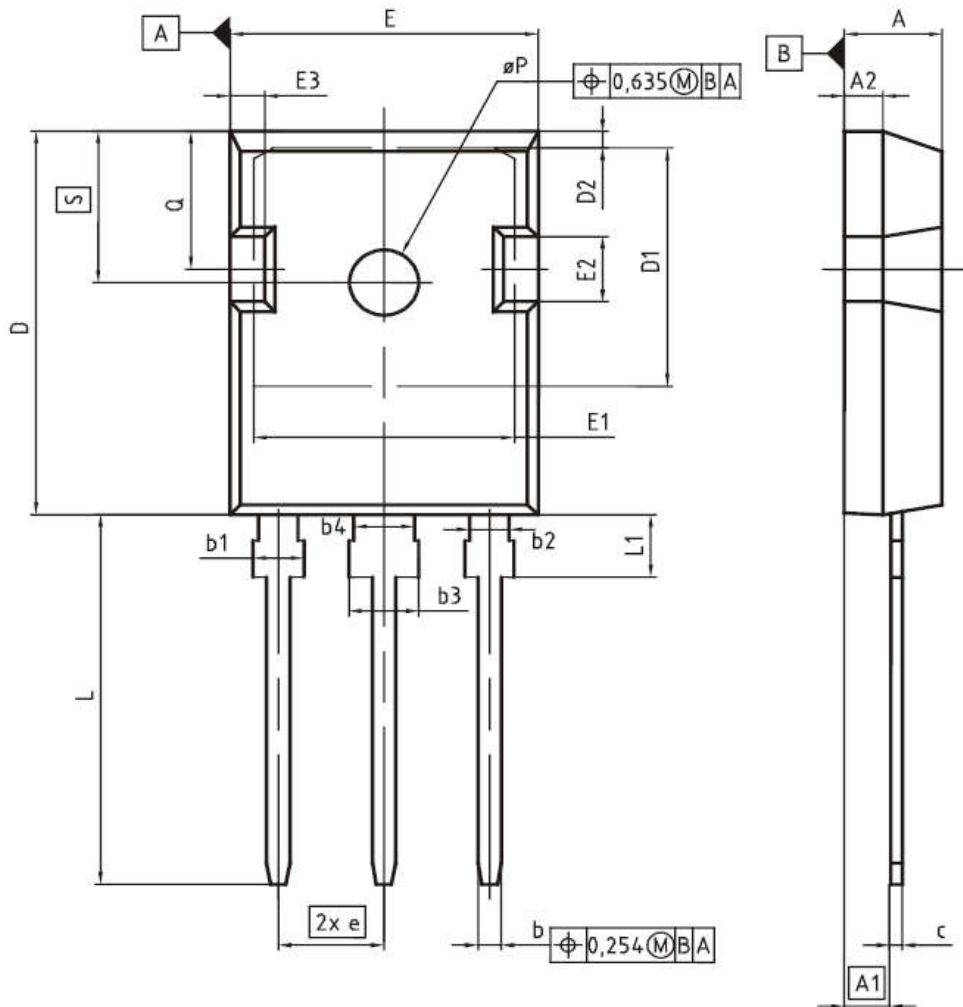

Fig. 10 Capacitance characteristics



**PG-TO247-3**

DIM	MILLIMETERS		INCHES	
	MIN	MAX	MIN	MAX
A	4.83	5.21	0.190	0.205
A1	2.27	2.54	0.089	0.100
A2	1.85	2.16	0.073	0.085
b	1.07	1.33	0.042	0.052
b1	1.90	2.41	0.075	0.095
b2	1.90	2.16	0.075	0.085
b3	2.87	3.38	0.113	0.133
b4	2.87	3.13	0.113	0.123
c	0.55	0.68	0.022	0.027
D	20.80	21.10	0.819	0.831
D1	16.25	17.65	0.640	0.695
D2	0.95	1.35	0.037	0.053
E	15.70	16.13	0.618	0.635
E1	13.10	14.15	0.516	0.557
E2	3.68	5.10	0.145	0.201
E3	1.00	2.60	0.039	0.102
e	5.44 (BSC)		0.214 (BSC)	
N	3		3	
L	19.80	20.32	0.780	0.800
L1	4.10	4.47	0.161	0.176
øP	3.50	3.70	0.138	0.146
Q	5.49	6.00	0.216	0.236
S	6.04	6.30	0.238	0.248