

# 承认书

(APPROVAL SHEET)

品名 Description	绕线电阻器
规格 Specification	KNP 全系列
客户料号 Part No	
kayocota 料号 Part No	
备注 Remark	符合环保 <input checked="" type="checkbox"/> ROHS <input checked="" type="checkbox"/> REACH <input checked="" type="checkbox"/> HALOGEN <input type="checkbox"/> OTHER

使用厂商:

制造厂商: 嘉莹兴

核准 Approval	校对 Check By	主办 Prepared By

核准 Approval	校对 Check By	主办 Prepared By
黄锦华	韩佩芝	韩飞

公司章	
-----	--

公司章	
-----	--

地址: 深圳市龙岗区平湖镇鹅公岭春湖工业区三栋  
Add: 3rd block, Chunhu Industrial Zone, Egongling,  
Pinghu Town, Longgang District, Shenzhen.

TEL: 0755-89635343

FAX: 0755-33621650

## 1.适用范围 Applicable Scope

此基准是供应充电器、节能灯、电源供应器用之不燃性涂装型绕线型保险丝电阻器之规格。

Applicable Scope: This benchmark is the supply of chargers, power supply, and other energy-saving lamps used in the coating are incombustibility fusible wound resistor type of specifications.

## 2.形名 Part Number

依据其种类、额定电力、端子形状、公称电阻值及容许误差等分别注明。

It is composed by Type, Rated Wattage, Terminal Form, and Nominal Resistance and Tolerance.e.g.

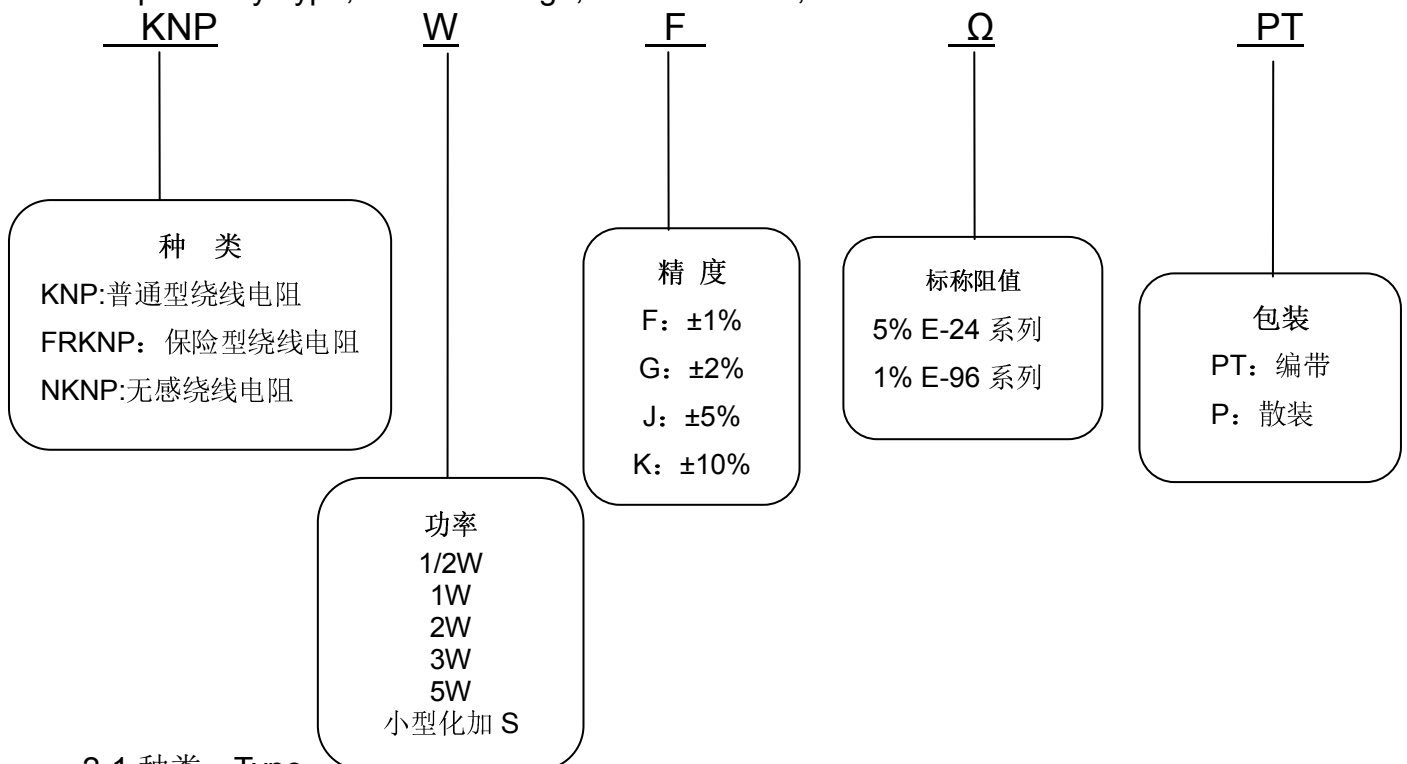

### 2-1.种类 Type

绕线型电阻器以 KNP 表示之。

Wire Wound Resistor is called "KNP"

### 2-2.额定电力 Rated Wattage

额定电力(W)以数字表示, 如 1W。

Shown by "W"、such as 1W。

### 2-3.端子形状 Terminal Form

视端子区分为 PT 形、P 形、M 形、F 形。

Upon the shape of terminal, it has PT Form and P form, M form, F form

### 2-4.公称电阻值 Nominal Resistance:

Ω 为单位,依据 JIS-C6402 为适用原则(E-24 Series)。

Ω are its unit which is in accordance with JIS-C6402(E-24)series.

### 2-5.电阻值及容许误差 Tolerance

在室温中依检测器测量,应在指定电阻值之容许误差以内。

It is measured by Bridge-method at room temperature and expressed by a capital letter.

F ± 1%    G ± 2%    J ± 5%    K ± 10%

### 2-6.KAYOCOTA 定制合金线:

### 3. 額定功率 Rated power

額定電力是周圍溫度 70℃ 以下可連續使用之負載電力最大值數,且應使機械性能與電氣性能滿足。當周圍溫度超越上記溫度時,依造圖一之電力輕減曲線而定。

Rated power is the value of Max load voltage specified at the ambient temperature of 70℃ and shall meet the functions of electrical and mechanical performance. When the ambient temp. surpasses above Mentioned temperature. The value declines as following DERATING CURVE:



圖 1: 負載減輕曲線

#### 3-1. 額定電壓 Rated Voltage

依公式  $E = \sqrt{PR}$  求出連續使用額定電壓,如額定電壓超出最高使用電壓,則以最高使用電壓為連續使用額定電壓

It is calculated as the following formula  $E = \sqrt{PR}$

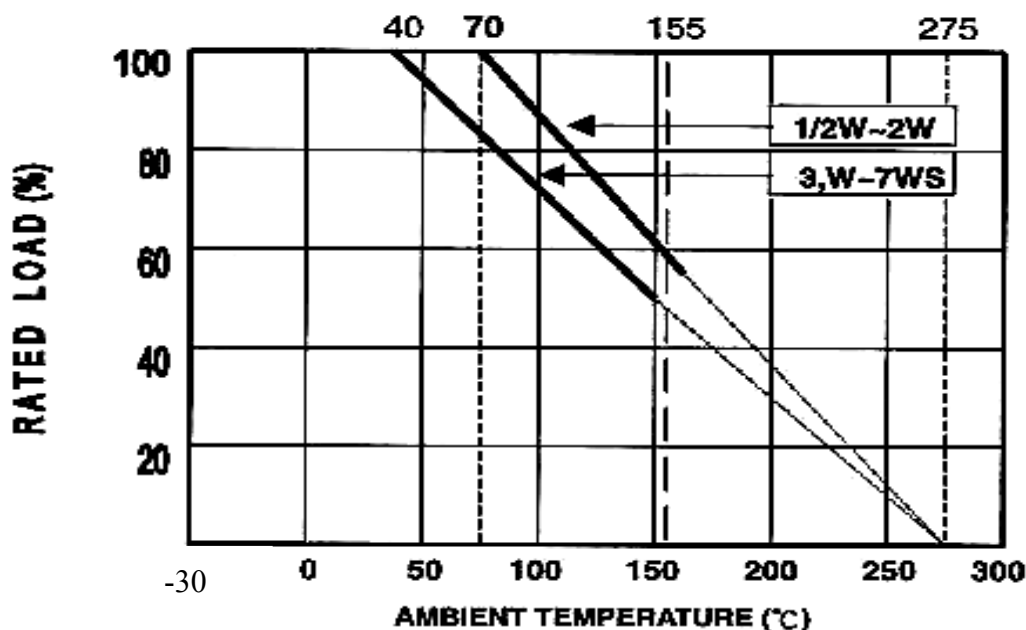
However, in case the voltage calculated exceeds the maximum load voltage, such the maximum load. Voltage shall be regarded as its rated voltage, means whichever less.

E=連續使用額定電壓	E=Rated Continuous Working Voltage(V)
P=額定功率	P=Rated Power(W)
R=公稱電阻值	R=Nominal Resistance Value( $\Omega$ )

#### 3-2 備注

1. K N P 阻抗範圍 0.01  $\Omega$  -1K  $\Omega$  (N K N P 則為 0.01  $\Omega$  -100  $\Omega$ ).
2. 無感繞線電阻(N K N P)的特性說明:

本項產品可減少各種電子回路的雜訊或瞬間突破,如用在交換式電源供應器或不斷電設備之電流感應器(Current Sensory)或突破吸收部分(Snubbed)時,可將雜訊干擾降至最低限度,提高振頻率或縮小前產品的體積,節省材料費用,並可防止振蕩,且突破降低自然可減少電磁波之干擾。

#### 4. 構造 CONSTRUCTOION

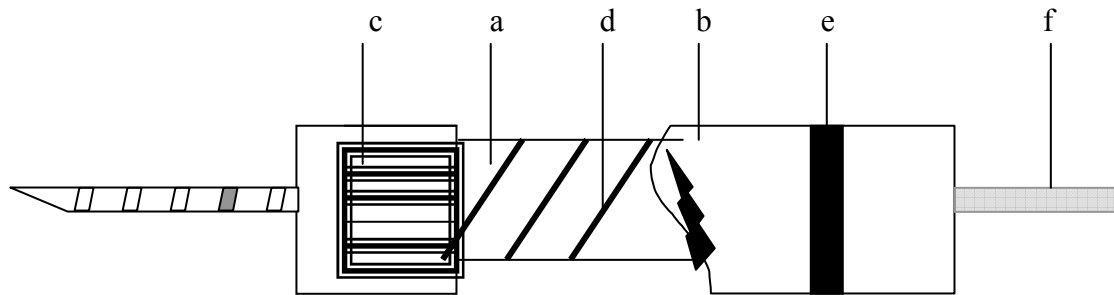

- a. 高熱傳導瓷心 CERAMIC CORE (HIGH CONDUCTIVITY)
- b. 不燃性絕緣塗漆 (NONFLAME PAINT WITH SOL VENT-PROOF)
- c. 壓合度良好之高信賴性端帽 END CAP(HIGH RELIABILITY FITTING BY ORIGINAL CAP-PRESSING METHOD)
- d. 高穩定性鎳鉻合金線原材料 COPPER-NICKEL ALLOY WIRE WOUND FILM(HIGH STABILITY)
- e. 符合 MIT& EIA 規定之標準色碼帶 COLOR CODE(PER MIL&ELA STAND ARDS PERMANENT)
- f. 鍍錫導線 LEAD WIRE

#### 5. 定格及尺寸 SPECIFICATIONS

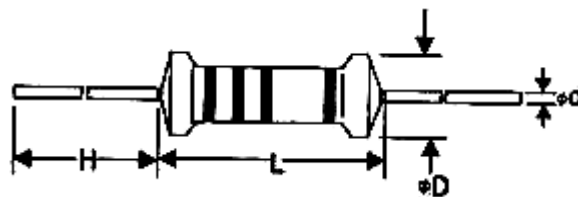

額定電力 POWER RATING	DIMENSION(mm)					阻值範圍 RESISTANCE RANGE
	L	D	H	d ±0.02	DIELECTRIC WITHSTANDING	
1/2W/1WS	9.0 ±0.5	3.2 ±0.5	26 ±2.0	0.56	300	0.01Ω-100Ω
1W/2WS	11.5 ±1.0	4.5 ±0.5	35 ±1.0	0.65	350	0.01Ω-360Ω
2W/3WS	15.5 ±1.0	5.0 ±0.5	33 ±1.0	0.70	500	0.01Ω-470Ω
3W/5WS	17.0 ±1.0	6.5 ±0.5	32 ±1.0	0.75	500	0.01Ω-1KΩ
5W/7WS	24.0 ±1.0	8.5 ±0.5	28 ±3.0	0.75	700	0.01Ω-1KΩ
10W	53.0 ±1.0	8.5 ±1.0	38±1.0	0.80	700	0.01Ω-1KΩ

## 6.機械性能 Mechanical Performance

### 6-1.端子彎曲強度 Terminal Bend

一手持電阻體,另一手將端子彎曲 90°後,恢復原位,繼續再向反方向彎曲 90°,如此三次

而接頭不可脫落或折斷。

The terminal shall withstand 4 bends of 90° rotation without any breakage or damage, when the Resistor is fixed in vertical position.

### 6-2.端子拉力強度 Terminal Tensile

將電阻本體一端固定,另一端向電阻體軸方向,慢慢加重至 2.5Kg 後,保持 10 秒鐘,本體不得脫落或鬆動。

Fixing the resistor body, a static load of 2.5Kg is to be gradually applied into the terminal for 10seconds without causing any looseness and fall.

### 6-3.扭轉強度 Twist Withstand

自電阻體起約 6mm 處之端子線,以約 0.8mm 曲率半徑彎曲 90°,其次由彎曲處向端子線先端 1.2±0.4mm 處挾定端子引出軸,為回轉軸,以約 5 秒時間沿面回軸 360°再逆轉 360°,如此施行回逆轉 2 次,不可發生折斷及鬆動現象。

To bend the lead wire at the point of about 6mm from resistor body to 90°,then catch the wire at 1.2±0.4mm apart from the bend point end and turn it (clockwise) by 360 degrees Perpendicular to the resistor axis at speed of sane 5 seconds per turn, and do the same Counterclockwise again which constitute a whole turn. Repeat the turn for 2 times without Causing any break and looseness.

## 7.使用溫度:Operating Temperature Range

-50°C ~ 275°C 以內

**8. 電氣特性 ELECTRICAL PERFORMANCE**

项目 ITEM	规格值 SPECIFICATIONS	试验方法 TEST METHODS (JIS C5202)
抵抗值 DC RESISTANCE	须在规定之 R 值的容许差内 ALLOWED UNDER R RATE TOLERANCE	
短时间过负载 SHORT TIME OVER LOAD	$\pm(2\%+0.1\Omega)$ 以内 $\pm(2\%+0.1\Omega)$ LESS THAN	额定电压 2.5 倍测试 5 秒 2.5 TIMES RATED VOLTAGE FOR 5s
耐电压 DIELECTRIC WITHSTANDING VOLTAGE	涂装不可损坏, 绝缘不可破坏 NO EVIDENCE OF FLASHOVER MECHANICAL DAMAGE ARCING OR INSULATION BREAKDOWN	电阻体置于 V 型槽上, 依特性表之电压规定加压 60 秒 RESISTORS SHALL BE CLAMPED IN V-BLOCK AND SHALL BE TEST AT SPECIFIED IN THE ABOVE LIST FOR 60 SECONDS
焊锡附着性 ADHESION OF SOLDERABILITY	端子表面积 95%以新焊锡所覆盖为原则 95% SURFACE OF TERMINAL COVERED BY SOLDER	$260^{\circ}\text{C} \pm 5^{\circ}\text{C}$ ( $^{\circ}\text{C}$ ) 5S $\pm$ 0.5S (sec)
不燃性 INCOMBUSTIBILITY	无出现火焰 NO EVIDENCE OF FLAME	UL94-VO
耐溶剂性 RESISTANCE TO SOLVENT	涂漆及色码无脱落 NO DETERIORATION OF PROTECTIVE COATING AND MARKINGS	放入稀释剂中 3 分钟 ADD THINNER IN 3 MINUTES
负荷寿命 LOAD LIFE	$\pm(5\%+0.05\Omega)$ 以内 WITHIN $\pm(5\%+0.05\Omega)$	70 $^{\circ}\text{C}$ 1000 小时 额定电压(90 分钟 ON, 30 分钟 OFF) 70 $^{\circ}\text{C}$ 1000h RATED VOLTAGE

9. 色碼表示 Color Coding

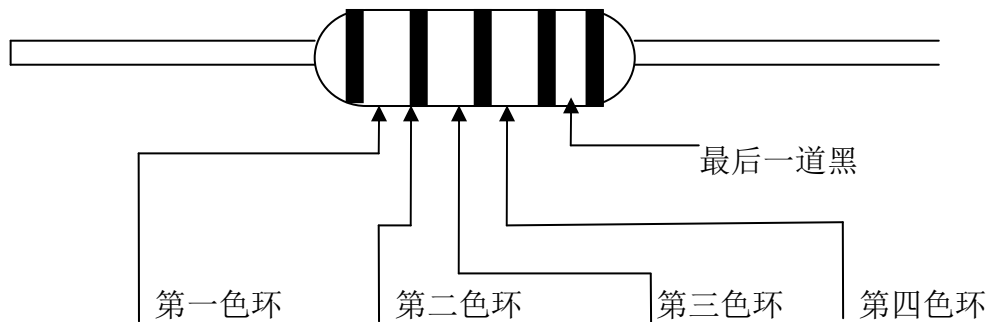

Color 颜色	第一条 1 the significant	第二条 2 nd significant	倍数 Multiplier	误差 Error
Black 黑	0	0	10 <sup>0</sup>	
Brown 棕	1	1	10 <sup>1</sup>	±1%(F)
Red 红	2	2	10 <sup>2</sup>	±2%(G)
Orange 橙	3	3	10 <sup>3</sup>	
Yellow 黄	4	4	10 <sup>4</sup>	
Green 绿	5	5	10 <sup>5</sup>	±0.5%(D)
Blue 蓝	6	6	10 <sup>6</sup>	±0.25%(C)
Violet 紫	7	7		±0.1%(B)
Grey 灰	8	8		
White 白	9	9	10 <sup>-3</sup>	
Golden 金			10 <sup>-1</sup>	±5%(J)
Silver 银			10 <sup>-2</sup>	±10%(K)

注:Note 本体面漆: 涂灰色不燃性绝缘漆。 Body coating Gray

10. 注意事項 REQUIREMENTS IN USE

- 濕氣會使電極之焊錫劣質化,保持場所在溫度 40℃ 以下濕度 70%以下。  
IN THE HIGH HUMIDITY SITUATION, IT WILL MAKE THE SOLDER ABILITY WORST. PLEASE PRESERVE THE RESISTORS IN 40℃ ,70 RH BELOW
- 儘量不要打開最小包裝。  
PLEASE DON'T OPEN THE MINE PACKAGE WHEN YOU PRESERVE IT
- 周圍溫度高時按照負荷減輕曲線圖減少使規定用電力。  
WHEN IN THE HIGH TEMPERATURE SITUATION, PLEASE ACCORD TO THE PICTURE OF "POWER DERATING CURVE" REDUCE THE USE OF POWER RATING
- 儘量不要將多個電阻並列或直列連結, 而以大電壓或大電流使用。  
YOU SHOULD AVOID THE CONNECTOR OF RESISATNCE REPLACED BY LATGE VOLTAGE AND POWER

5. 由於特殊塗料之故，對外部衝極力較弱，故注意各種處置。

DUE TO ITS SPECIAT MATERIAL OF PAINT, YOU MUST BE CAREFUL TO  
TIS WEAK APPEARANCE

6. 洗淨後，外膜多少會弱化，然後自然放置後可復元其強度所以洗淨後 20 分鐘內不要讓電阻皮  
膜與任何品之接觸。

AFTER CLEANING THE BODY, IT WILL MAKE THE FILM WEAKER. BUT IF YOU LET IT  
NATURE DRY WITHOUT TOUCHING OR PAINTING

ANYTHING, THE RESISTORS WILL RECOVER ITS STRENGTH BY 20 MINUTES

7. 電阻為發熱性零件，所以電阻間不應相互堆積或接近其它發熱零件組成,而防礙其散熱性。

THE RESISTORS ARE REQUESTED NOT TO PLACE BY THE OTHER HEATING  
ACCESSORIE, WHICH WILL OBSTRUCT THEIR HEAT DISSIPATION

### 11. 帶狀尺寸 Type dimensions

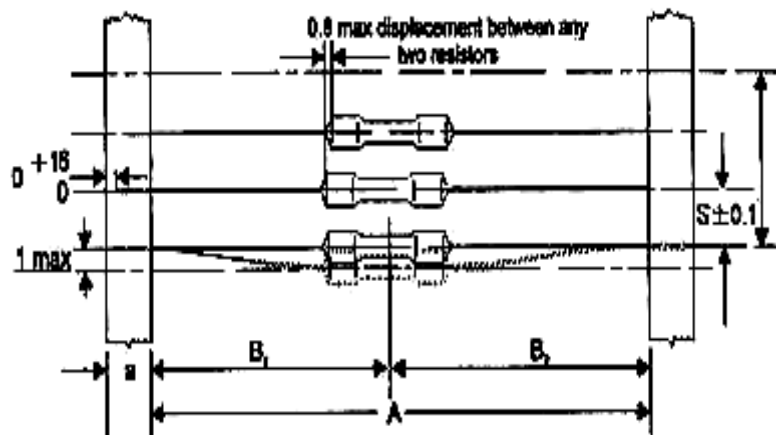

STYLE		DIMENSIONS(mm)				
Normal	Miniature	a	A	B1-B2	S(Spacing)	T (Max. deviation of spacing)
TYPE-25	TYPE50S	$6 \pm 0.5$	$52.5 \pm 1.5$	1.2	5	1 mm per 10 spacing 0.5mm per 5 spacing
			$26.0 \pm 1.5$	1.0		
TYPE-50	TYPE1WS	$6 \pm 0.5$	$52.5 \pm 1.5$	1.2	5	
TYPE100	TYPE2WS	$6 \pm 0.5$	$61.0 \pm 1.5$	1.5	5	
TYPE2W	TYPE3WS	$6 \pm 0.5$	$68.0 \pm 1.5$	1.5	10	
TYPE3W	TYPE5WS	$6 \pm 0.5$	$68.0 \pm 1.5$	1.5	10	
TYPE5W		$6 \pm 0.5$	$82.0 \pm 1.5$	1.5	10	



12. 包裝 Packing

12-1 帶式包裝 Taping Type

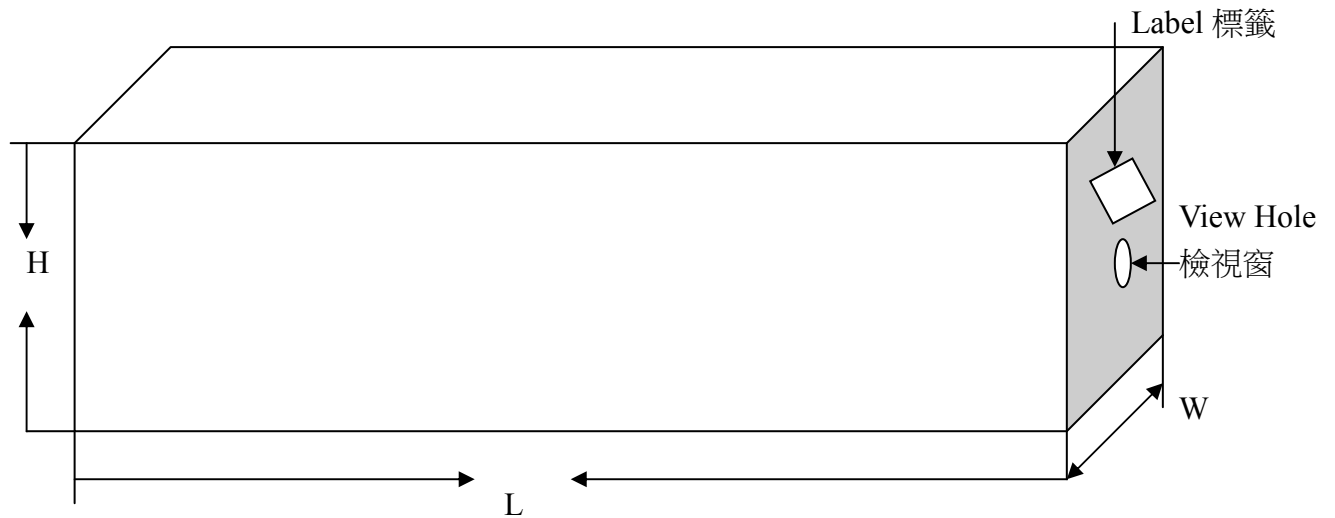

TYPE	WATTS	W(mm)	H(mm)	L(mm)	QTY(pcs)
T-52	1/2W/ 1WS	73	57	255	1000
T-73	1W/ 2WS	92	83	267	1000
	2WS/ 3WS	92	100	267	1000
	3W/5WS	92	83	267	500
	5W	92	83	267	500