

ROHS compliant

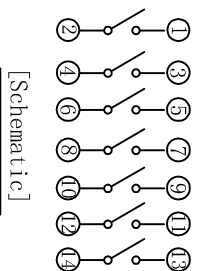
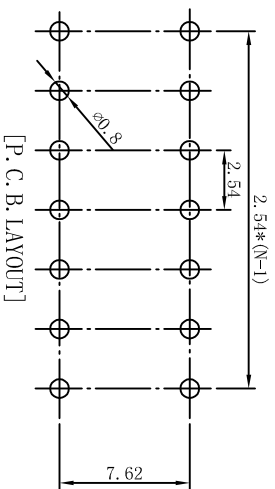
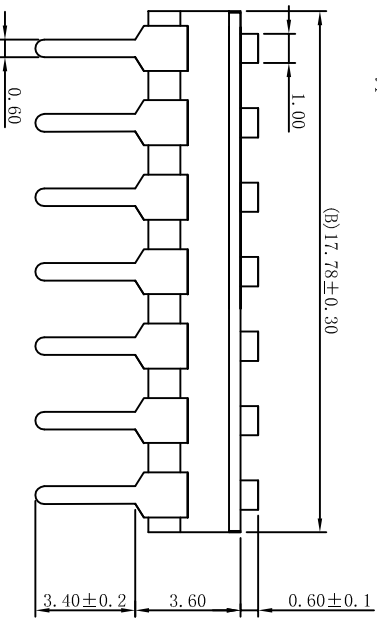
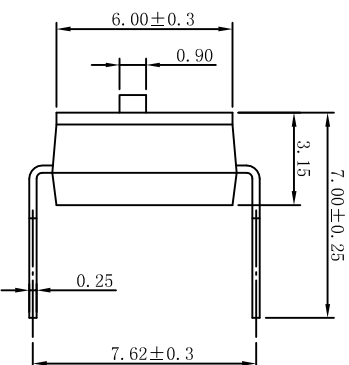
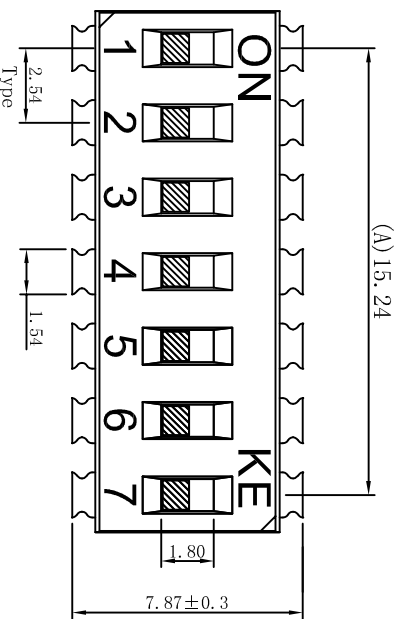

NOTES:

1.Specification:

- 1> Operation force: 1000gf Max.
- 2> Operation Temperature: -30 °C to +85 °C.
- 3> Storage Temperature: -40 °C to +85 °C.
- 4> Mechanical Life: 3000 cycles operations.
- 5> Resistance to Soldering: 260 ±5 °C for 3-5 Seconds.

2.PLATING:

- 1> GOLD Flash 1u" (min) SOLDERTAIL, 3u" GOLD PLATING ON THE CONTACT AREA.

3.ELECTRICAL:

- 1> Non-switch Rating: 100mA at 50V DC.
- 2> Switching Rating: 25mA at 24V DC.
- 3> Contact Resistance: Initial 50mΩ Max. Contact Resistance: After life 100mΩ Max.
- 4> Insulation Resistance: 1000MΩ Min at 50VDC.
- 5> Dielectric Strength: 500V AC for 60seconds.
- 6> Switch Capacitance: 5PF Max at 1MHZ.

4.PART NUMBER DESCRIPTION:

DSIC XX L S G E T

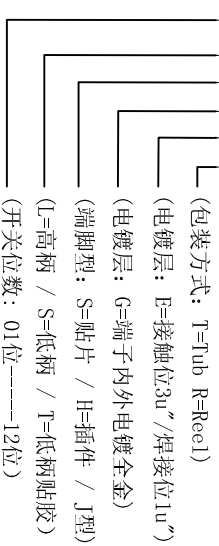

5.PACKING: 29pcs/Tube, 1450pcs/Box.

REV.	ECN NO.	DRAWN	DATE

Drawing	dengkg	Date	2018.03.24	LINER	ANGLES	PRODUCT Family	DSIC Series Pitch 2.54mm
Check	zhong	Scale	4:1	>0±0.05	>0° ±0.5°	PRAT NO.	DSIC07LHGT
Approved		Unit	MM	>1±0.10	>5° ±1.0°	FILE NO.	KE-DSIC-007-H-A
Size	A4	Rev.	A	>10±0.30		PROJECTION	

东莞市康深电子科技有限公司
Kongshen Electronics technology co., LTD.