

Summary

PS2701 is a small patch optoelectronic coupling device, suitable for surface mount production.

PS2701 is a optocoupler composed of a gallium arsenide led and a phototransistor. Its volume is smaller than dip. It is suitable for high-density surface mount applications, such as programmable controllers.

Characteristic

- Current conversion ratio (CTR) range: 50~300% ($I_F=5mA, V_{CE}=5V$)
- Input output isolation voltage ($V_{iso}=5000 V_{rms}$)
- Collector Emitter Breakdown Voltage $BV_{CEO} \geq 80V$
- Working temperature: $-55 \sim 110^\circ C$
- UL -approved : UL 1577, File No .E 492440
- Accord with REACH and RoHS

Application

- Switching power supply, smart meter
- Industrial control, measuring instruments
- Office equipment, such as photocopiers
- Household appliances, such as air conditioners, fans, water heaters, etc

Structural schematic diagram

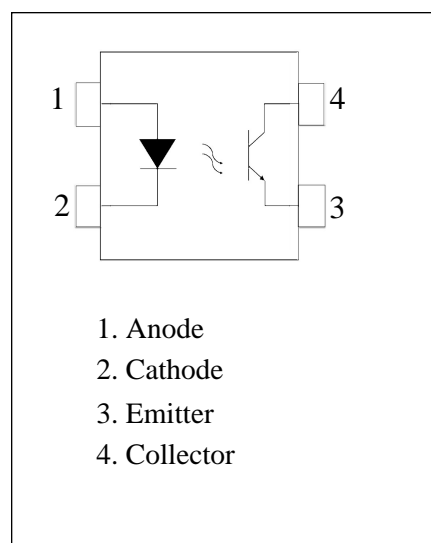

Limit parameter (Ta=25°C)

Parameter		Symbol	Condion	Unit
Input	Forward current	I_F	50	mA
	Forward pulse current	I_{FP}	1	A
	Reverse voltage	V_R	6	V
	Power derating	$\Delta P_D / ^\circ C$	0.8	mW/ $^\circ C$
	Power waste	P_D	80	mW/ch
	Junction temperature	T_j	125	$^\circ C$
Output	Collector power consumption	P_c	150	mW
	Collector current	I_c	50	mA
	Collector Emitter Voltage	V_{CEO}	80	V
	Emitter collector voltage	V_{ECO}	7	V
	Junction temperature	T_j	125	$^\circ C$
Total power consumption		P_{tot}	200	mW
Isolation voltage		V_{iso}	5000	V_{rms}
working temperature		T_{opr}	$-55 \sim +110$	$^\circ C$
Storage temperature		T_{stg}	$-55 \sim +150$	$^\circ C$
welding temperature		T_{sol}	260 (10s)	$^\circ C$

Photoelectric characteristics (Ta=25°C)

Parameter		Symbol	Condition	Min.	Typ.	Max.	Unit
Input	Forward voltage	V_F	$I_F=5mA$		1.1	1.4	V
	Reverse current	I_R	$V_R=5V$			5	μA
	Input capacitance	C_{in}	$V=0, f=1MHz$	-	30		pF
Output	Collector dark current	I_{CEO}	$V_{CE}=70V$			100	nA
	Collector Emitter Breakdown Voltage	BV_{CEO}	$I_C=0.1mA, I_F=0$	80			V
	Emitter collector breakdown voltage	BV_{ECO}	$I_E=0.1mA, I_F=0$	7			V
Transmission characteristics	Current conversion ratio	CTR	$I_F=5mA, V_{CE}=5V$	50	100	300	%
	Collector Emitter Saturation Voltage Drop	$V_{CE(sat)}$	$I_F=10mA, I_C=2mA$			0.3	V
	Isolation resistance	R_{ISO}	DC1000V, 40~60%R.H.	1×10^{11}			Ω
	Isolation capacitance	C_f	$V=0, f=1MHz$		0.6	1.0	pF
	Collector Emitter capacitance	C_{CE}	$V=0, f=1MHz$		10		pF
	Input output capacitance	C_S	$V=0, f=1MHz$		0.8		pF
	cut-off frequency	F_c	$V_{CE}=5V, I_C=2mA, R_L=100\Omega, -3dB$		80		kHz
Switching time	Rise time	T_r	$V_{CE}=5V, I_C=2mA, R_L=100\Omega$	-	3		μs
	Descent time	T_f			5		μs

* $CTR = I_C / I_F \times 100\%$

CTR Classification table

Model	Grading standard	Current conversion rate(%)(I_C/I_F)		
		$I_F = 5mA, V_{CE} = 5V, T_a = 25^\circ C$		
		Min	Type	Max
PS2701	M	50	-	150
	P	150	-	300
	L	200	-	350
	K	300	-	450
	LK	400	-	600

Test circuit

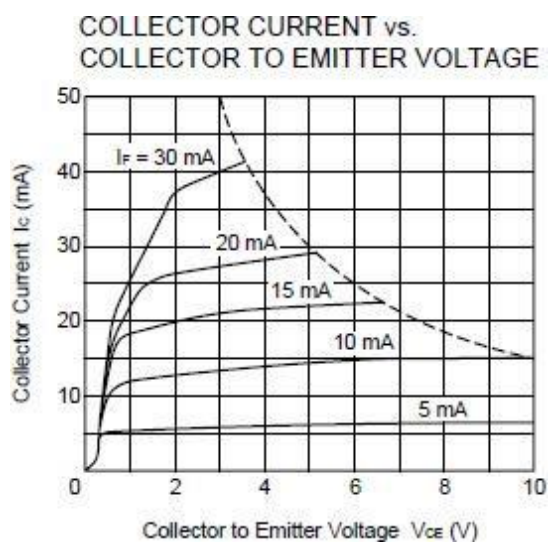
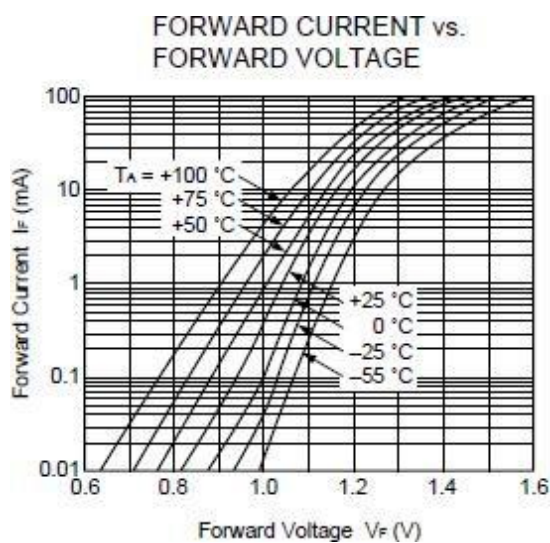
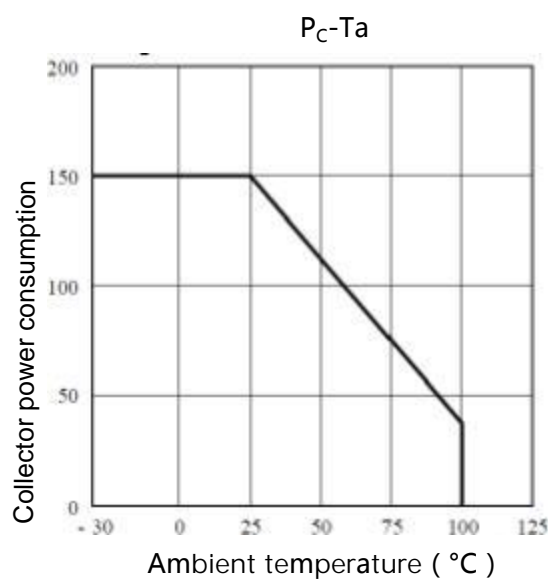
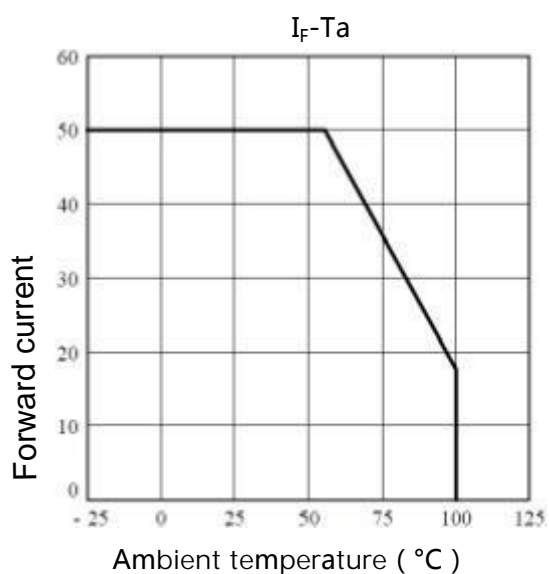
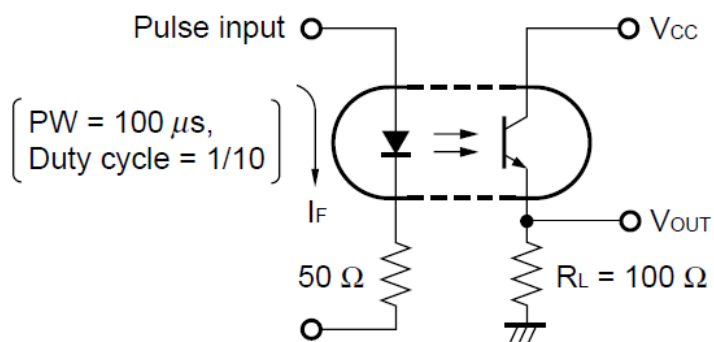

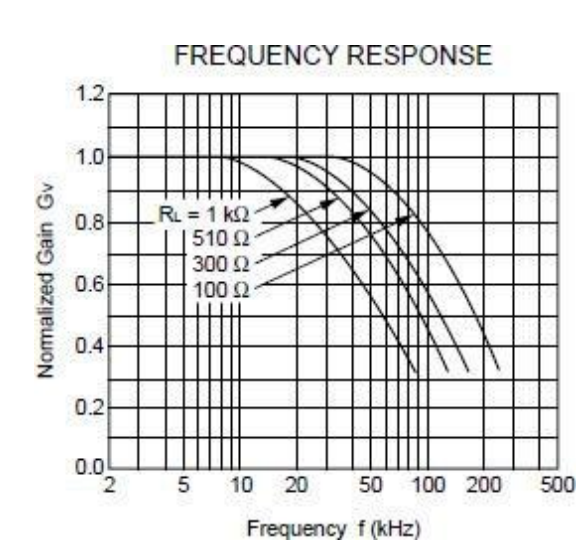
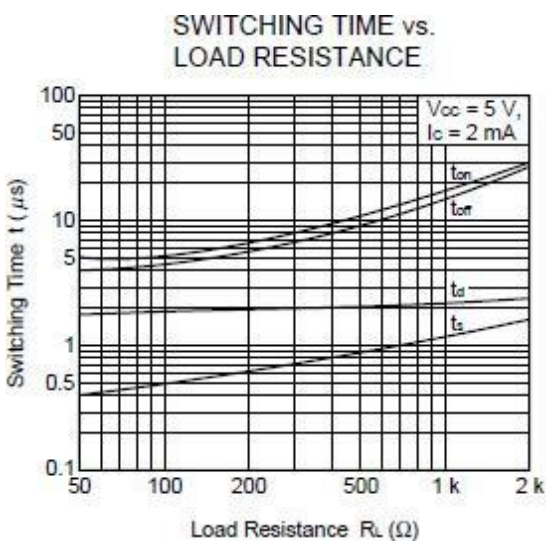
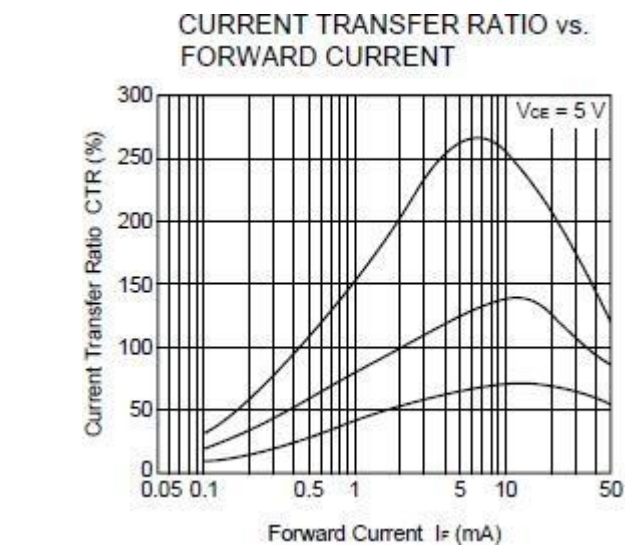
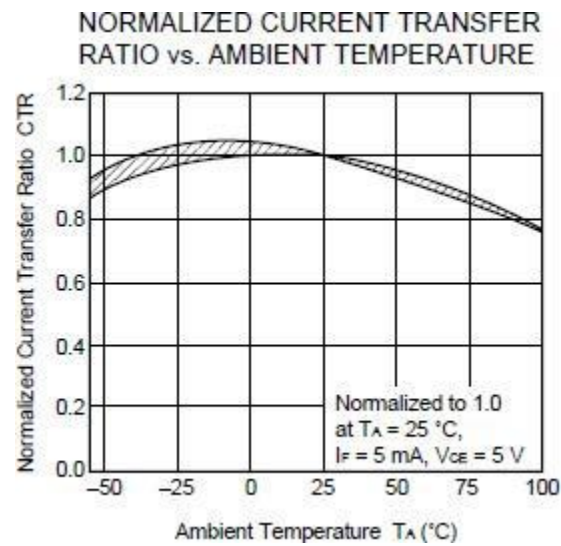
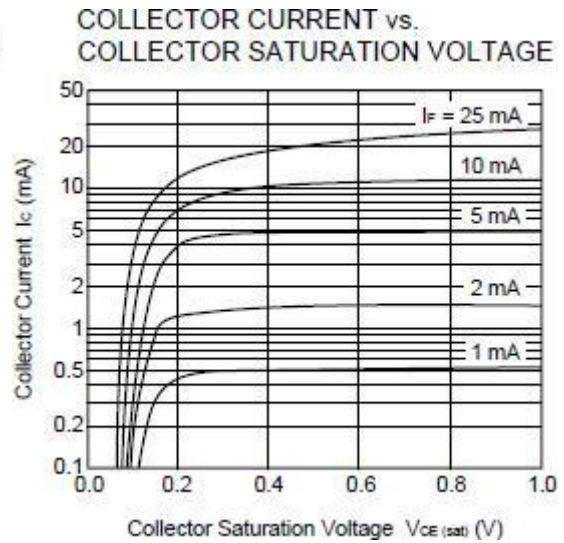
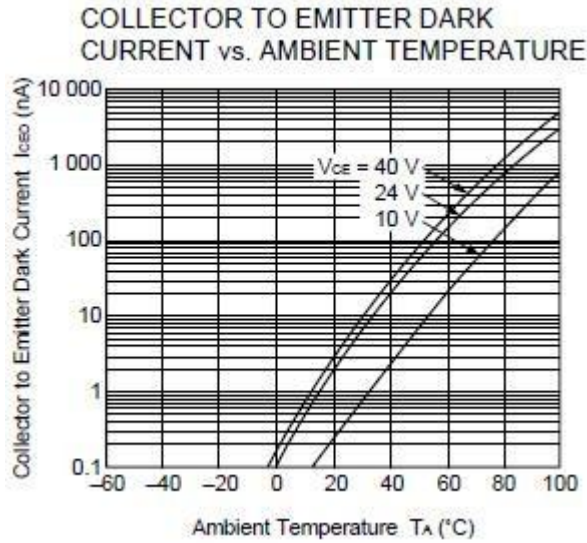

SWITCHING TIME vs. LOAD RESISTANCE

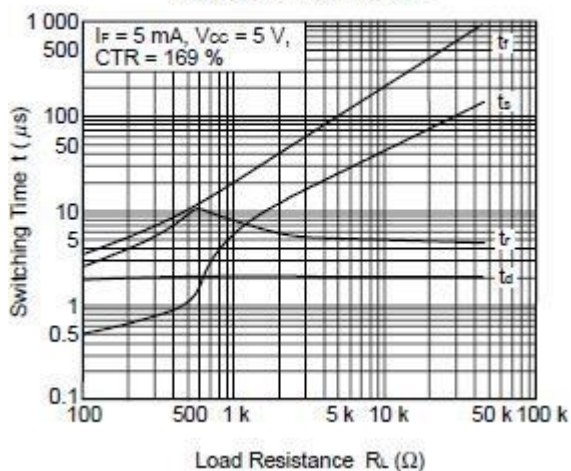

LONG TERM CTR DEGRADATION

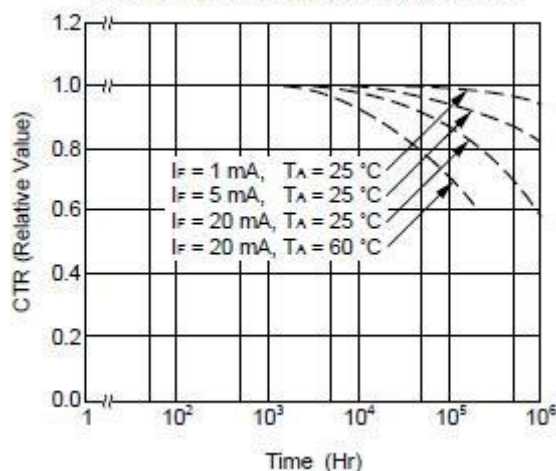

Reflow soldering temperature curve

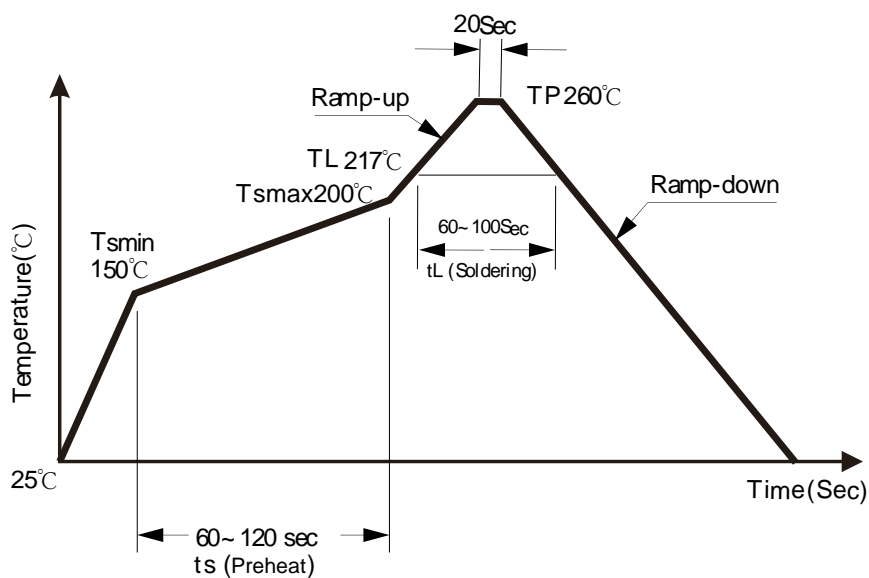

PACKAGE OUTLINE

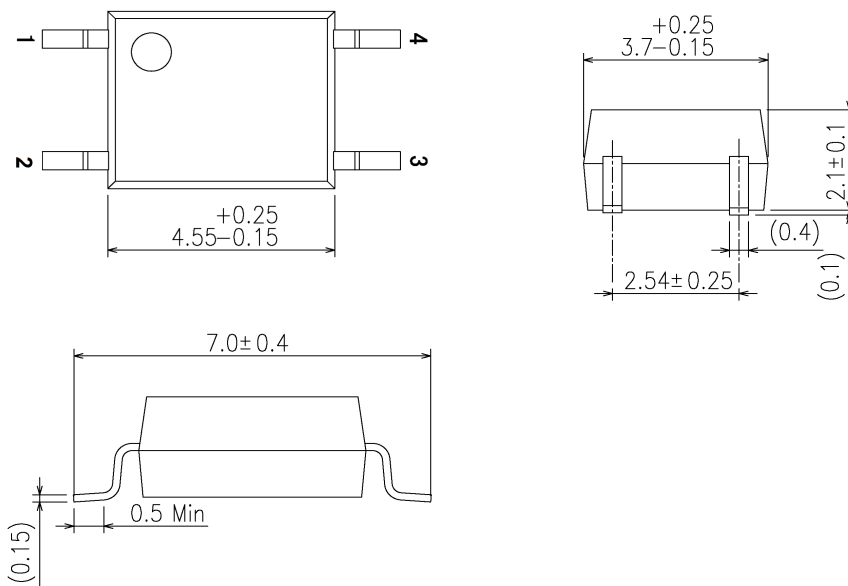

Marking

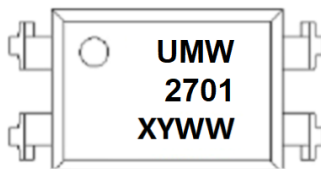

"X" : Grading standard

"YWW" : Year week number

Ordering information

Order Code	Package	Baseqty	Deliverymode
UMW PS2701-1-L	SOP-4	3000	Tape and reel