

### Summary

LTV-356T is a small shape chip optoelectronic coupling device, suitable for surface mount production.

LTV-356T is a optocoupler composed of a GaAs light-emitting diode and a phototransistor. Its volume is smaller than dip, and it is suitable for high-density surface mount applications, such as programmable logic controller.

Structural schematic diagram

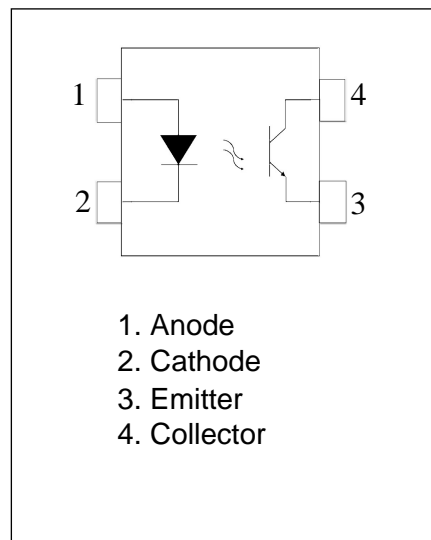

### Characteristic

- Current conversion ratio (CTR) range: 50 ~ 600% (if = 5mA, VCE = 5V)
- Input output isolation voltage (VISO = 3750 VRMs)
- Collector Emitter Breakdown Voltage BVCEO ≥ 80V
- Working temperature: - 55 - 110 °C
- UL -approved : UL 1577, File No .E 492440
- Accord with REACH and RoHS

### Application

- Switching power supply, smart meter
- Industrial control, measuring instruments
- Office equipment, such as copiers
- Such as household appliances, fans, etc

### Limit parameter (Ta=25°C)

Parameter		Symbol	Rating	Company
Input	Forward current	$I_f$	50	mA
	Forward pulse current	$I_{FP}$	1	A
	Reverse voltage	$V_r$	6	V
	power waste	P	70	mW
	Junction temperature	$T_j$	125	°C
Output	Collector power consumption	$P_c$	150	mW
	Collector current	$I_c$	50	mA
	Collector Emitter Voltage	$V_{CEO}$	80	V
	Emitter collector voltage	$V_{ECO}$	7	V
	Junction temperature	$T_j$	125	°C
Total power consumption		$P_{tot}$	200	mW
Isolation voltage		$V_{iso}$	3750	Vrms
working temperature		$T_{opr}$	-55~+110	°C
Storage temperature		$T_{stg}$	-55~+125	°C
welding temperature		$T_{sol}$	260	°C

## Photoelectric characteristics (Ta=25°C)

Parameter		Symbol	Condition	Min.	Typ.	Max.	Unit
Input	Forward voltage	$V_F$	$I_F=20mA$		1.2	1.4	V
	Reverse current	$I_R$	$V_R=5V$	-	-	10	$\mu A$
	Terminal capacitance	$C_t$	$V=0, f=1kHz$	-	30	250	pF
Output	Collector dark current	$I_{CEO}$	$V_{CE}=70V$	-	-	100	nA
	Collector Emitter Breakdown Voltage	$BV_{CEO}$	$I_C=0.1mA, I_F=0$	80	-	-	V
	Electrode Emitter Breakdown Voltage	$BV_{ECO}$	$I_E=0.1mA, I_F=0$	7	-	-	V
Transmission characteristics	Current conversion ratio	CTR	$I_F=5mA, V_{CE}=5V$	50	-	600	%
	Collector Emitter Saturation Voltage Drop	$V_{CE(sat)}$	$I_F=20mA, I_C=1mA$	-	0.1	0.2	V
	Isolation resistance	$R_{ISO}$	DC1000V, 40-60%R.H.	$1 \times 10^1$	-	-	$\Omega$
	Isolation capacitance	$C_f$	$V=0, f=1MHz$	-	0.6	1.0	pF
	Collector Emitter capacitance	$C_{CE}$	$V=0, f=1MHz$		10		pF
	cut - off frequency	$F_c$	$V_{CE}=5V, I_C=2mA,$ $R_L=100\Omega, -3dB$	-	80	-	kHz
Switching time	rise time	$T_r$	$V_{CE}=10V, I_C=2mA,$ $R_L=100\Omega$	-	4	18	$\mu s$
	Descent time	$T_f$		-	3	18	$\mu s$

\*  $CTR=I_C/I_F \times 100\%$

## CTR classification table

Model	Classification standard	$I_C(mA)$		Corresponding CTR%	
		$I_F = 5mA, V_{CE} = 5V, T_a = 25^\circ C$		$I_F = 5mA, V_{CE} = 5V, T_a = 25^\circ C$	
		Min	Max	Min	Max
LTV-356T	Blank	2.5	30.0	50	600
	A	4.0	8.0	80	160
	B	6.5	13.0	130	260
	C	10.0	20.0	200	400
	D	15.0	30.0	300	600
	A or B	4.0	13.0	80	160
	B or C	6.5	20.0	130	400
	C or D	10.0	30.0	200	600
	A,B or C	4.0	20.0	80	400
	B,C or D	6.5	30.0	130	600
	A,B,C or D	4.0	30.0	80	600

Test circuit

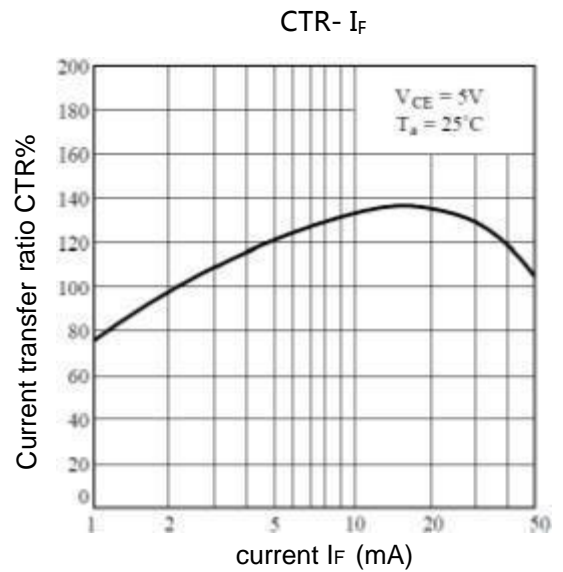
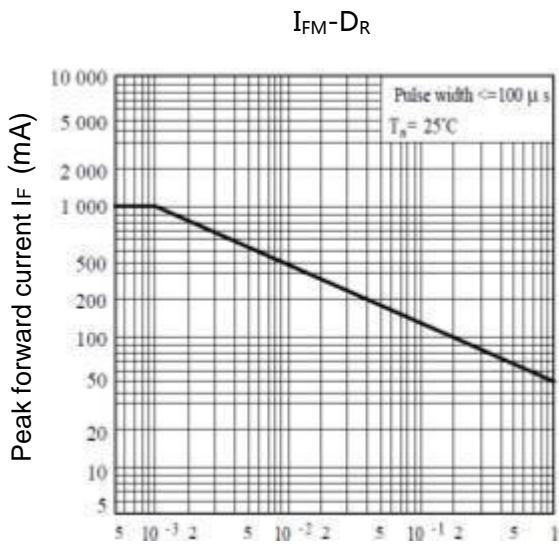
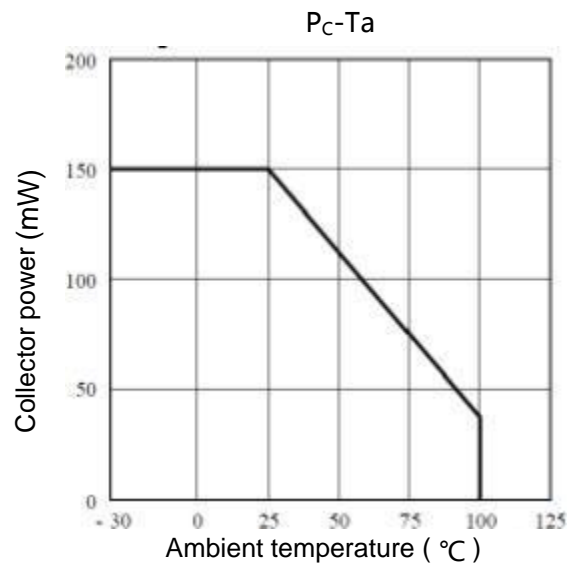
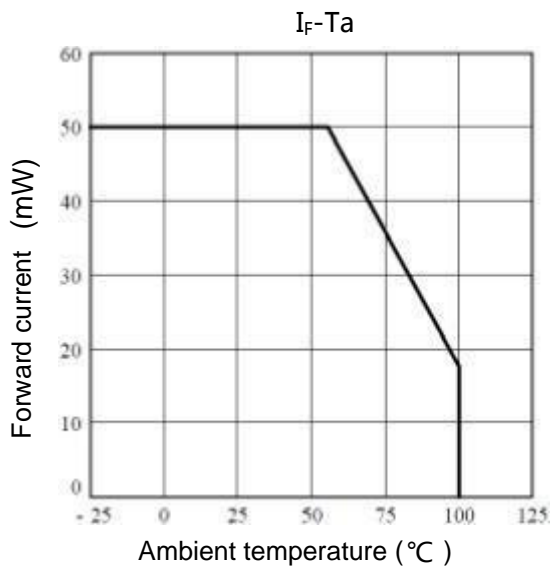
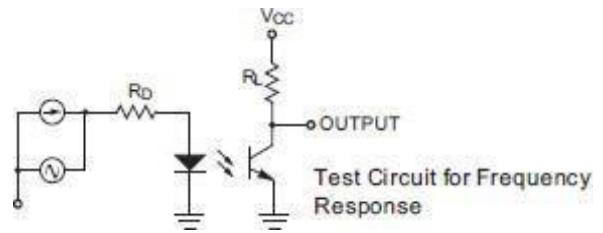
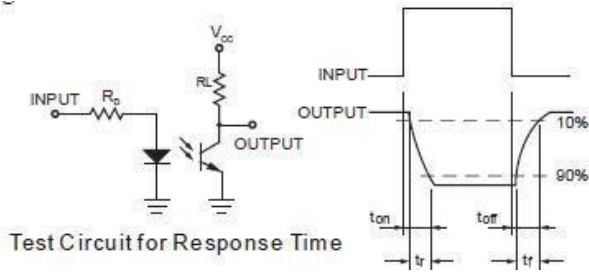

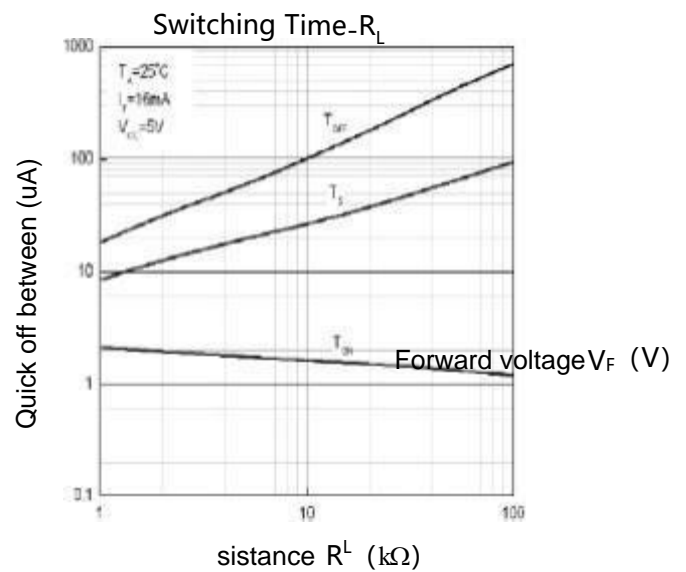
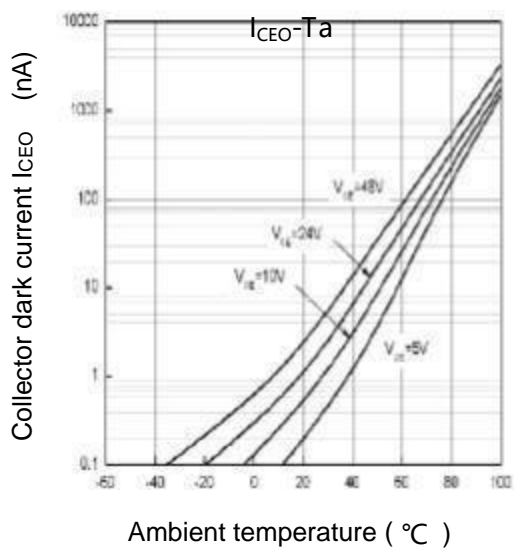
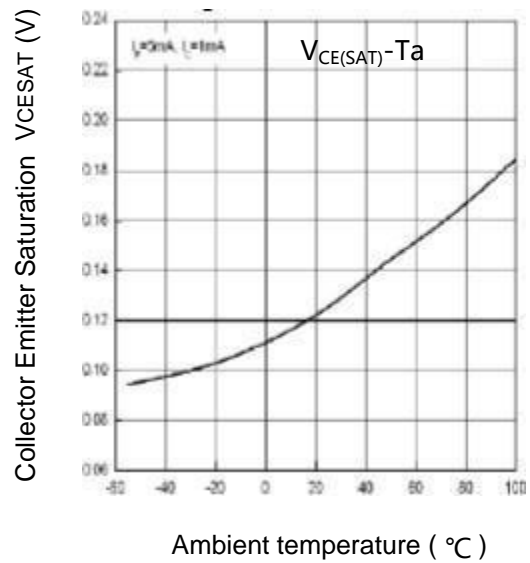
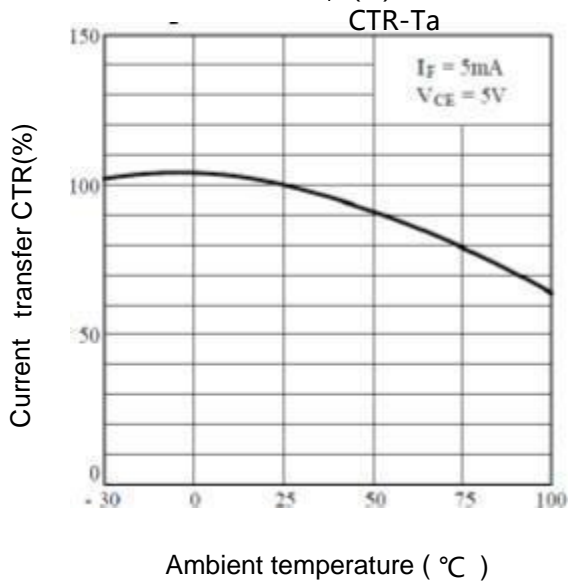
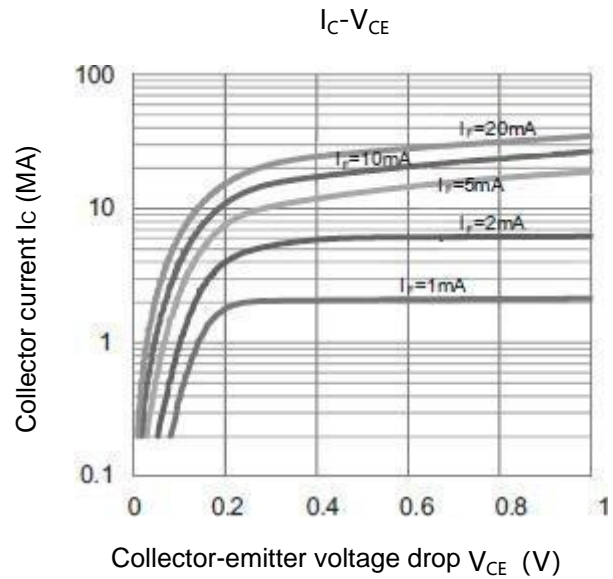
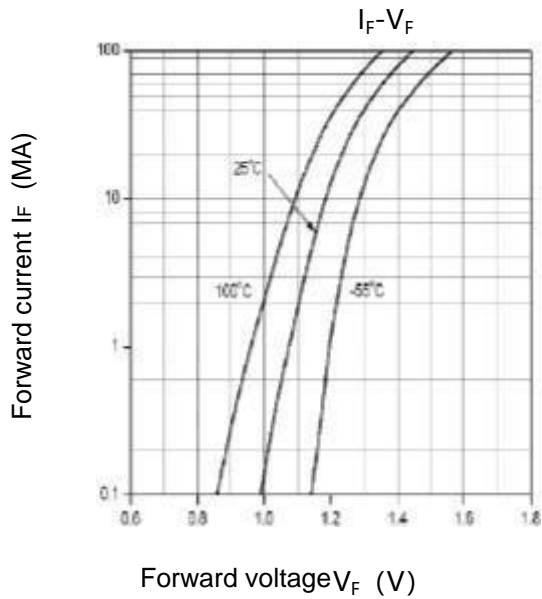

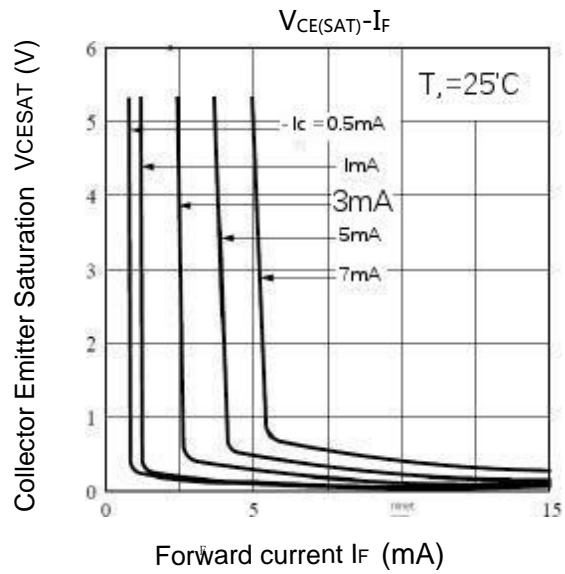
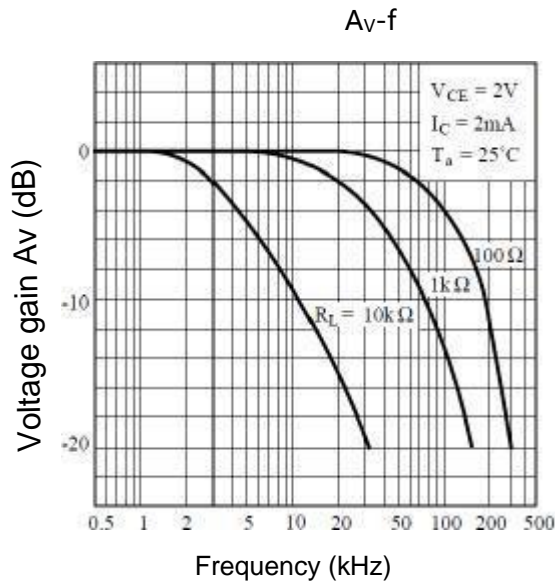

Reflow temperature curve

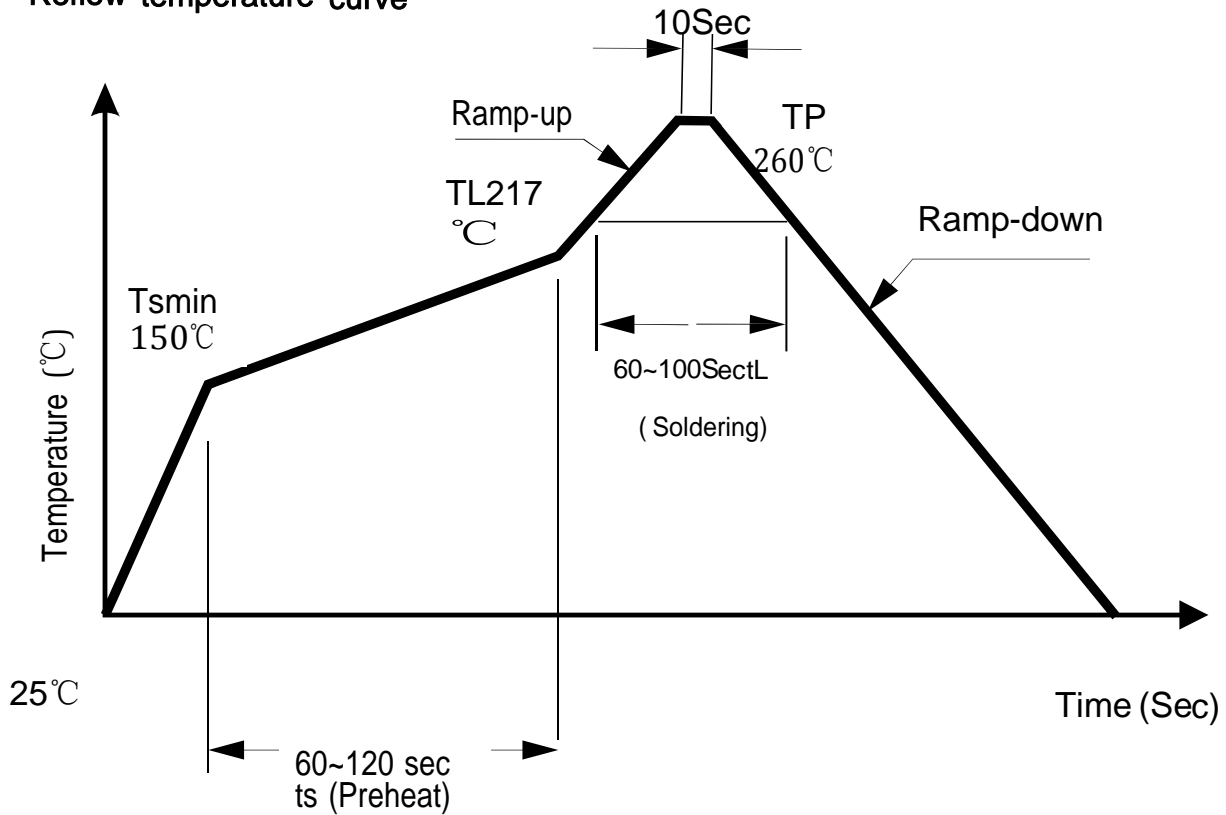

**PACKAGE OUTLINE**

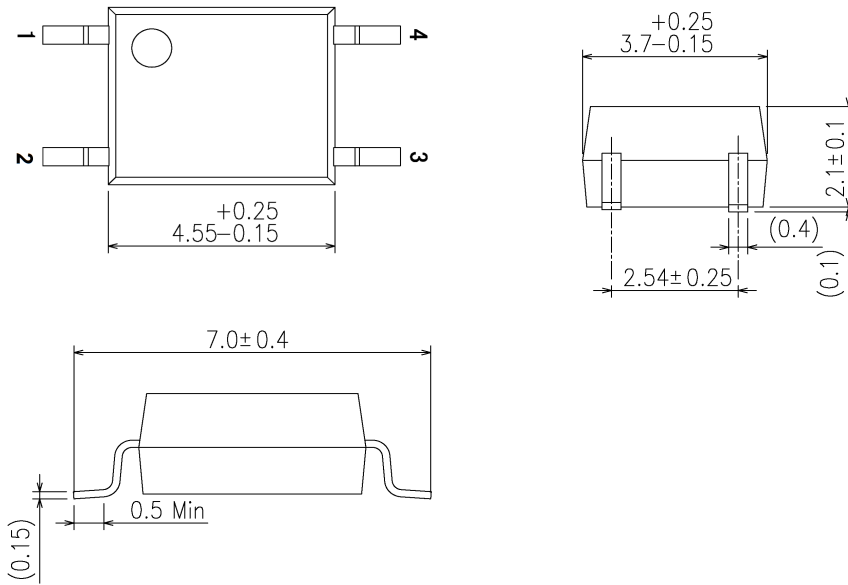

**Marking**

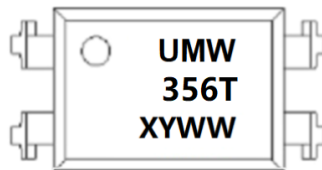

"X" : Grading standard

"YWW" : Year week number

**Ordering information**

Order Coder	Package	Baseqty	Deliverymode
UMW LTV-356T-A	SOP-4	3000	Tape and reel
UMW LTV-356T-B	SOP-4	3000	Tape and reel
UMW LTV-356T-C	SOP-4	3000	Tape and reel
UMW LTV-356T-D	SOP-4	3000	Tape and reel