

## Features

- ◆ Working peak reverse voltage range – 5.0V to 440V.
- ◆ Peak power dissipation 1500W @10 x 1000 us Pulse
- ◆ Low profile package.
- ◆ Excellent clamping capability.
- ◆ Glass passivated junction.
- ◆ Fast response time: typically less than 1 ns for Uni-direction. Less than 5 ns for Bi-direction, from 0 Volts to BV min
- ◆ Typical IR less than 1uA above 10V.
- ◆ Plastic material has UL flammability classification 94V-O
- ◆ RoHS compliant in lead-free versions

## Mechanical Characteristics

- ◆ CASE: Void-free, JEDEC DO-214AB Molded Plastic over glass passivated junction.
- ◆ Mounting Position: Any
- ◆ Polarity: by cathode band denotes uni-directional device, none cathode band denotes bi-directional device.
- ◆ Terminal: Solder plated, solderable per MIL-STD-750, Method 2026

## DO-214AB(SMC)

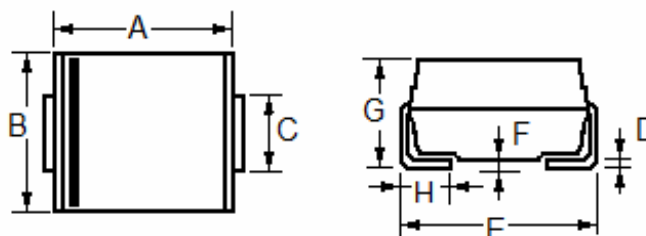

Dim	Millimeters		Inches	
	Min	Max	Min	Max
A	6.60	7.11	0.260	0.280
B	5.59	6.22	0.220	0.245
C	2.90	3.20	0.114	0.126
D	0.125	0.305	0.006	0.012
E	7.75	8.13	0.305	0.320
F	----	0.203	----	0.008
G	2.06	2.62	0.079	0.103
H	0.76	1.52	0.030	0.060

## Maximum Ratings And Characteristics @ 25°C Ambient Temperature (unless otherwise noted)

Parameter	Symbol	Value	Units
Peak Pulse Power Dissipation on 10/1000 us Waveform (Note 1, 2, FIG.1)	P <sub>PPM</sub>	Min 1500	W
Peak Pulse Current of on 10/1000us Waveform (Note 1, FIG.3)	I <sub>PPM</sub>	See Table 1	Amps
Peak Forward Surge Current, 8.3ms Single Half Sine-wave Superimposed on Rated Load, (JEDEC Method) (Note 2. 3)	I <sub>FSM</sub>	200	Amps
Operating Junction Temperature Range	T <sub>J</sub>	-55 to 150	°C
Storage Temperature Range	T <sub>STG</sub>	-55 to 150	°C

Notes:

1. Non-repetitive current pulse, per Fig.3 and derated above T<sub>A</sub>=25°C per Fig.2.
2. Mounted on 5.0mm<sup>2</sup> (0.03mm thick) Copper Pads to each terminal.
3. 8.3ms single half sine-wave, or equivalent square wave, Duty cycle=4 pluses per minute maximum.

## Electrical Characteristics @ Tamb 25°C



## 1500W Surface Mount Transient Voltage Suppressors

Type Number		Marking		Reverse Stand-Off Voltage	Breakdown Voltage Min. @I <sub>T</sub>	Breakdown Voltage Max. @ I <sub>T</sub>	Test Current	Maximum Clamping Voltage @I <sub>PP</sub>	Peak Pulse Current	Reverse Leakage @V <sub>RMW</sub>
(Uni)	(Bi)	(Uni)	(Bi)	V <sub>RWM</sub> (V)	V <sub>BR MIN</sub> (V)	V <sub>BR MAX</sub> (V)	I <sub>T</sub> (mA)	V <sub>C</sub> (V)	I <sub>PP</sub> (A)	I <sub>R</sub> (uA)
SMCJ5.0	SMCJ5.0C	GDD	BDD	5.0	6.40	7.55	10.0	9.6	156.3	800.0
SMCJ5.0A	SMCJ5.0CA	GDE	BDE	5.0	6.40	7.25	10.0	9.2	163.0	800.0
SMCJ6.0	SMCJ6.0C	GDF	BDF	6.0	6.67	8.45	10.0	11.4	131.6	800.0
SMCJ6.0A	SMCJ6.0CA	GDG	BDG	6.0	6.67	7.67	10.0	10.3	145.6	800.0
SMCJ6.5	SMCJ6.5C	GDH	BDH	6.5	7.22	9.14	10.0	12.3	122.0	500.0
SMCJ6.5A	SMCJ6.5CA	GDK	BDK	6.5	7.22	8.30	10.0	11.2	133.9	500.0
SMCJ7.0	SMCJ7.0C	GDL	BDL	7.0	7.78	9.86	10.0	13.3	112.8	200.0
SMCJ7.0A	SMCJ7.0CA	GDM	BDM	7.0	7.78	8.95	10.0	12.0	125.0	200.0
SMCJ7.5	SMCJ7.5C	GDN	BDN	7.5	8.33	10.67	1.0	14.3	104.9	100.0
SMCJ7.5A	SMCJ7.5CA	GDP	BDP	7.5	8.33	9.58	1.0	12.9	116.3	100.0
SMCJ8.0	SMCJ8.0C	GDQ	BDQ	8.0	8.89	11.3	1.0	15.0	100.0	50.0
SMCJ8.0A	SMCJ8.0CA	GDR	BDR	8.0	8.89	10.23	1.0	13.6	110.3	50.0
SMCJ8.5	SMCJ8.5C	GDS	BDS	8.5	9.44	11.92	1.0	15.9	94.3	20.0
SMCJ8.5A	SMCJ8.5CA	GDT	BDT	8.5	9.44	10.82	1.0	14.4	104.2	20.0
SMCJ9.0	SMCJ9.0C	GDU	BDU	9.0	10.0	12.6	1.0	16.9	88.8	10.0
SMCJ9.0A	SMCJ9.0CA	GDV	BDV	9.0	10.0	11.5	1.0	15.4	97.4	10.0
SMCJ10	SMCJ10C	GDW	BDW	10	11.1	14.1	1.0	18.8	79.8	5.0
SMCJ10A	SMCJ10CA	GDX	BDX	10	11.1	12.8	1.0	17.0	88.2	5.0
SMCJ11	SMCJ11C	GDY	BDY	11	12.2	15.4	1.0	20.1	74.6	5.0
SMCJ11A	SMCJ11CA	GDZ	BDZ	11	12.2	14.0	1.0	18.2	82.4	5.0
SMCJ12	SMCJ12C	GED	BED	12	13.3	16.9	1.0	22.0	68.2	5.0
SMCJ12A	SMCJ12CA	GEE	BEE	12	13.3	15.3	1.0	19.9	75.4	5.0
SMCJ13	SMCJ13C	GEF	BEF	13	14.4	18.2	1.0	23.8	63.0	5.0
SMCJ13A	SMCJ13CA	GEG	BEG	13	14.4	16.5	1.0	21.5	69.8	5.0
SMCJ14	SMCJ14C	GEH	BEH	14	15.6	19.8	1.0	25.8	58.1	5.0
SMCJ14A	SMCJ14CA	GEK	BEK	14	15.6	17.9	1.0	23.2	64.7	5.0
SMCJ15	SMCJ15C	GEL	BEL	15	16.7	21.1	1.0	26.9	55.8	5.0
SMCJ15A	SMCJ15CA	GEM	BEM	15	16.7	19.2	1.0	24.4	61.5	5.0
SMCJ16	SMCJ16C	GEN	BEN	16	17.8	22.6	1.0	28.8	52.1	5.0
SMCJ16A	SMCJ16CA	GEP	BEP	16	17.8	20.5	1.0	26.0	57.7	5.0
SMCJ17	SMCJ17C	GEQ	BEQ	17	18.9	23.9	1.0	30.5	49.2	5.0
SMCJ17A	SMCJ17CA	GER	BER	17	18.9	21.7	1.0	27.6	54.3	5.0
SMCJ18	SMCJ18C	GES	BES	18	20.0	25.3	1.0	32.2	46.6	5.0
SMCJ18A	SMCJ18CA	GET	BET	18	20.0	23.3	1.0	29.2	51.4	5.0
SMCJ20	SMCJ20C	GEU	BEU	20	22.2	28.1	1.0	35.8	41.9	5.0
SMCJ20A	SMCJ20CA	GEV	BEV	20	22.2	25.5	1.0	32.4	46.3	5.0

※ For Bi-directional type having VRWM of 10 Volts and less, the IR limit is double



## 1500W Surface Mount Transient Voltage Suppressors

Type Number		Marking		Reverse Stand-Off Voltage	Breakdown Voltage Min. @I <sub>T</sub>	Breakdown Voltage Max. @ I <sub>T</sub>	Test Current	Maximum Clamping Voltage @I <sub>PP</sub>	Peak Pulse Current	Reverse Leakage @V <sub>RMW</sub>
(Uni)	(Bi)	(Uni)	(Bi)	V <sub>RMW</sub> (V)	V <sub>BR MIN</sub> (V)	V <sub>BR MAX</sub> (V)	I <sub>T</sub> (mA)	V <sub>C</sub> (V)	I <sub>PP</sub> (A)	I <sub>R</sub> (uA)
SMCJ22	SMCJ22C	GEW	BEW	22	24.4	30.9	1.0	39.4	38.1	5.0
SMCJ22A	SMCJ22CA	GEX	BEX	22	24.4	28.0	1.0	35.5	42.3	5.0
SMCJ24	SMCJ24C	GEY	BEY	24	26.7	33.8	1.0	43.0	34.9	5.0
SMCJ24A	SMCJ24CA	GEZ	BEZ	24	26.7	30.7	1.0	38.9	38.6	5.0
SMCJ26	SMCJ26C	GFD	BFD	26	28.9	36.6	1.0	46.6	32.2	5.0
SMCJ26A	SMCJ26CA	GFE	BFE	26	28.9	33.2	1.0	42.1	35.6	5.0
SMCJ28	SMCJ28C	GFF	BFF	28	31.1	39.4	1.0	50.0	30.0	5.0
SMCJ28A	SMCJ28CA	GFG	BFG	28	31.1	35.8	1.0	45.4	33.0	5.0
SMCJ30	SMCJ30C	GFH	BFH	30	33.3	42.2	1.0	53.5	28.0	5.0
SMCJ30A	SMCJ30CA	GFK	BFK	30	33.3	38.3	1.0	48.4	31.0	5.0
SMCJ33	SMCJ33C	GFL	BFL	33	36.7	46.5	1.0	59.0	25.4	5.0
SMCJ33A	SMCJ33CA	GFM	BFM	33	36.7	42.2	1.0	53.3	28.1	5.0
SMCJ36	SMCJ36C	GFN	BFN	36	40.0	50.7	1.0	64.3	23.3	5.0
SMCJ36A	SMCJ36CA	GFP	BFP	36	40.0	46.0	1.0	58.1	25.8	5.0
SMCJ40	SMCJ40C	GFQ	BFQ	40	44.4	56.3	1.0	71.4	21.0	5.0
SMCJ40A	SMCJ40CA	GFR	BFR	40	44.4	51.1	1.0	64.5	23.3	5.0
SMCJ43	SMCJ43C	GFS	BFS	43	47.8	60.5	1.0	76.7	19.6	5.0
SMCJ43A	SMCJ43CA	GFT	BFT	43	47.8	54.9	1.0	69.4	21.6	5.0
SMCJ45	SMCJ45C	GFU	BFU	45	50.0	63.3	1.0	80.3	18.7	5.0
SMCJ45A	SMCJ45CA	GFV	BFV	45	50.0	57.5	1.0	72.7	20.6	5.0
SMCJ48	SMCJ48C	GJS	BSJ	48	53.3	67.5	1.0	85.5	17.5	5.0
SMCJ48A	SMCJ48CA	GFX	BFX	48	53.3	61.3	1.0	77.4	19.4	5.0
SMCJ51	SMCJ51C	GJU	BJU	51	56.7	71.8	1.0	91.1	16.5	5.0
SMCJ51A	SMCJ51CA	GFZ	BFZ	51	56.7	65.2	1.0	82.4	18.2	5.0
SMCJ54	SMCJ54C	GFW	BFW	54	60.0	76.0	1.0	96.3	15.6	5.0
SMCJ54A	SMCJ54CA	GGE	BGE	54	60.0	69.0	1.0	87.1	17.2	5.0
SMCJ58	SMCJ58C	GFY	BFY	58	64.4	81.6	1.0	103	14.6	5.0
SMCJ58A	SMCJ58CA	GGG	BGG	58	64.4	74.1	1.0	93.6	16.0	5.0
SMCJ60	SMCJ60C	GGD	BGD	60	66.7	84.5	1.0	107	14.0	5.0
SMCJ60A	SMCJ60CA	GGK	BGK	60	66.7	76.7	1.0	96.8	15.5	5.0
SMCJ64	SMCJ64C	GGF	BGF	64	71.1	90.1	1.0	114	13.2	5.0
SMCJ64A	SMCJ64CA	GGM	BGM	64	71.1	81.8	1.0	103	14.6	5.0
SMCJ70	SMCJ70C	GGH	BGH	70	77.8	98.6	1.0	125	12.0	5.0
SMCJ70A	SMCJ70CA	GGP	BGP	70	77.8	89.5	1.0	113	13.3	5.0
SMCJ75	SMCJ75C	GGL	BGL	75	83.0	105.7	1.0	134	11.2	5.0
SMCJ75A	SMCJ75CA	GGR	BGR	75	83.0	95.8	1.0	121	12.4	5.0
SMCJ78	SMCJ78C	GGN	BGN	78	86.0	109.8	1.0	139	10.8	5.0
SMCJ78A	SMCJ78CA	GGT	BGT	78	86.0	99.7	1.0	126	11.9	5.0

※ For Bi-directional type having VRWM of 10 Volts and less, the IR limit is double



## 1500W Surface Mount Transient Voltage Suppressors

Type Number		Marking		Reverse Stand-Off Voltage	Breakdown Voltage Min. @I <sub>T</sub>	Breakdown Voltage Max. @ I <sub>T</sub>	Test Current	Maximum Clamping Voltage @I <sub>PP</sub>	Peak Pulse Current	Reverse Leakage @V <sub>RMW</sub>
(Uni)	(Bi)	(Uni)	(Bi)	V <sub>RMW</sub> (V)	V <sub>BR MIN</sub> (V)	V <sub>BR MAX</sub> (V)	I <sub>T</sub> (mA)	V <sub>C</sub> (V)	I <sub>PP</sub> (A)	I <sub>R</sub> ( $\mu$ A)
SMCJ85	SMCJ85C	GGQ	BGQ	85	94.0	119.2	1.0	151	9.9	5.0
SMCJ85A	SMCJ85CA	GGV	BGV	85	94.0	108.2	1.0	137	10.9	5.0
SMCJ90	SMCJ90C	GGS	BGS	90	100	126.5	1.0	160	9.4	5.0
SMCJ90A	SMCJ90CA	GGX	BGX	90	100	115.5	1.0	146	10.3	5.0
SMCJ100	SMCJ100C	GGU	BGU	100	111	141.0	1.0	179	8.4	5.0
SMCJ100A	SMCJ100CA	GGZ	BGZ	100	111	128.0	1.0	162	9.3	5.0
SMCJ110	SMCJ110C	GGW	BGW	110	122	154.5	1.0	196	7.7	5.0
SMCJ110A	SMCJ110CA	GHE	BHE	110	122	140.5	1.0	177	8.5	5.0
SMCJ120	SMCJ120C	GGY	BGY	120	133	169.0	1.0	214	7.0	5.0
SMCJ120A	SMCJ120CA	GHG	BHG	120	133	153.0	1.0	193	7.8	5.0
SMCJ130	SMCJ130C	GHD	BHD	130	144	182.5	1.0	231	6.5	5.0
SMCJ130A	SMCJ130CA	GHK	BHK	130	144	165.5	1.0	209	7.2	5.0
SMCJ150	SMCJ150C	GHF	BHF	150	167	211.5	1.0	268	5.6	5.0
SMCJ150A	SMCJ150CA	GHM	BHM	150	167	192.5	1.0	243	6.2	5.0
SMCJ160	SMCJ160C	GHH	BHH	160	178	226.0	1.0	287	5.2	5.0
SMCJ160A	SMCJ160CA	GHP	BHP	160	178	205.0	1.0	259	5.8	5.0
SMCJ170	SMCJ170C	GHL	BHL	170	189	239.5	1.0	304	4.9	5.0
SMCJ170A	SMCJ170CA	GHR	BHR	170	189	217.5	1.0	275	5.5	5.0
SMCJ180	SMCJ180C	GHN	BHN	180	200	253.8	1.0	321	4.7	5.0
SMCJ180A	SMCJ180CA	GHT	BHT	180	200	230.4	1.0	290	5.2	5.0
SMCJ190	SMCJ190C	GHQ	BHQ	190	211	267.9	1.0	339	4.4	5.0
SMCJ190A	SMCJ190CA	GHU	BHU	190	211	243.2	1.0	306	4.9	5.0
SMCJ200	SMCJ200C	GHW	BHW	200	222	282.0	1.0	356	4.2	5.0
SMCJ200A	SMCJ200CA	GHV	BHV	200	222	256.0	1.0	322	4.7	5.0
SMCJ210	SMCJ210C	GHY	BHY	210	233	296.1	1.0	375	4.0	5.0
SMCJ210A	SMCJ210CA	GHW	BHW	210	233	268.8	1.0	339	4.4	5.0
SMCJ220	SMCJ220C	GJD	BJD	220	244	310.2	1.0	392	3.8	5.0
SMCJ220A	SMCJ220CA	GHX	BHX	220	244	281.6	1.0	355	4.2	5.0
SMCJ250	SMCJ250C	GJF	BJF	250	278	342.5	1.0	447	3.4	5.0
SMCJ250A	SMCJ250CA	GHZ	BHZ	250	278	309.0	1.0	403	3.7	5.0
SMCJ300	SMCJ300C	GJH	BJH	300	333	411.0	1.0	535	2.8	5.0
SMCJ300A	SMCJ300CA	GJE	BJE	300	333	371.0	1.0	484	3.1	5.0
SMCJ350	SMCJ350C	GJL	BJL	350	389	479.5	1.0	624	2.4	5.0
SMCJ350A	SMCJ350CA	GJG	BJG	350	389	432.0	1.0	565	2.7	5.0
SMCJ400	SMCJ400C	GJN	BJN	400	444	548.0	1.0	687	2.2	5.0
SMCJ400A	SMCJ400CA	GJK	BJK	400	444	494.0	1.0	645	2.3	5.0
SMCJ440	SMCJ440C	GJQ	BJQ	440	489	602.8	1.0	786	1.9	5.0
SMCJ440A	SMCJ440CA	GJM	BJM	440	489	543.0	1.0	710	2.1	5.0

※ For Bi-directional type having VRWM of 10 Volts and less, the IR limit is double



## 1500W Surface Mount Transient Voltage Suppressors

Ratings and Characteristic Curves  $T_A=25^\circ\text{C}$  unless otherwise noted

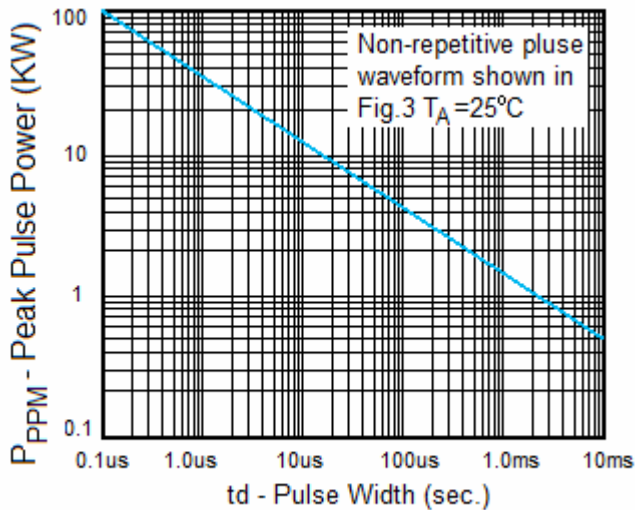

Fig. 1 Peak Pulse Power Rating

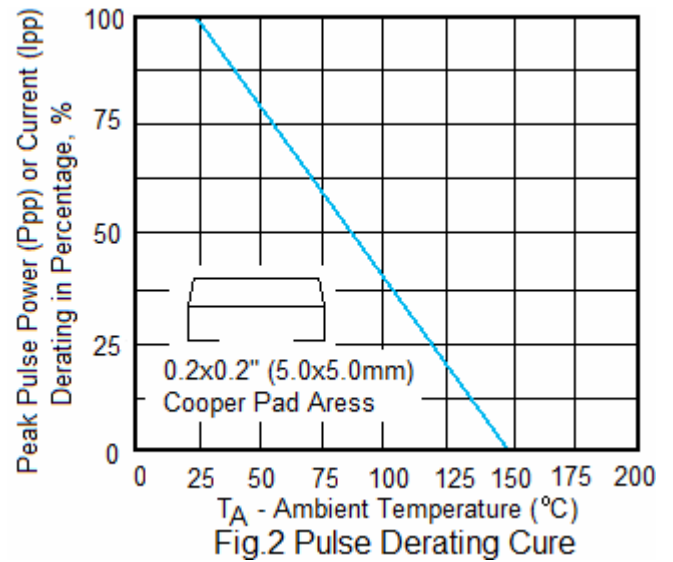

Fig. 2 Pulse Derating Curve

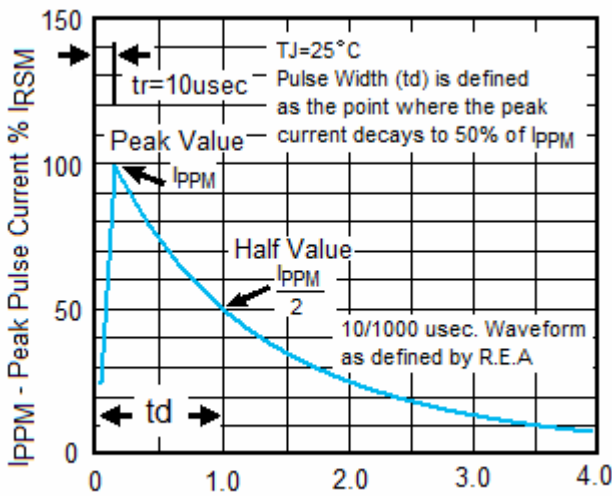

Fig. 3 Pulse Waveform

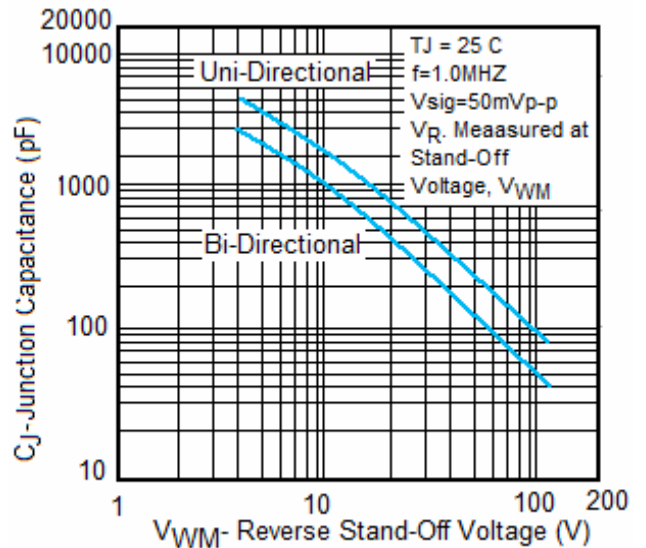
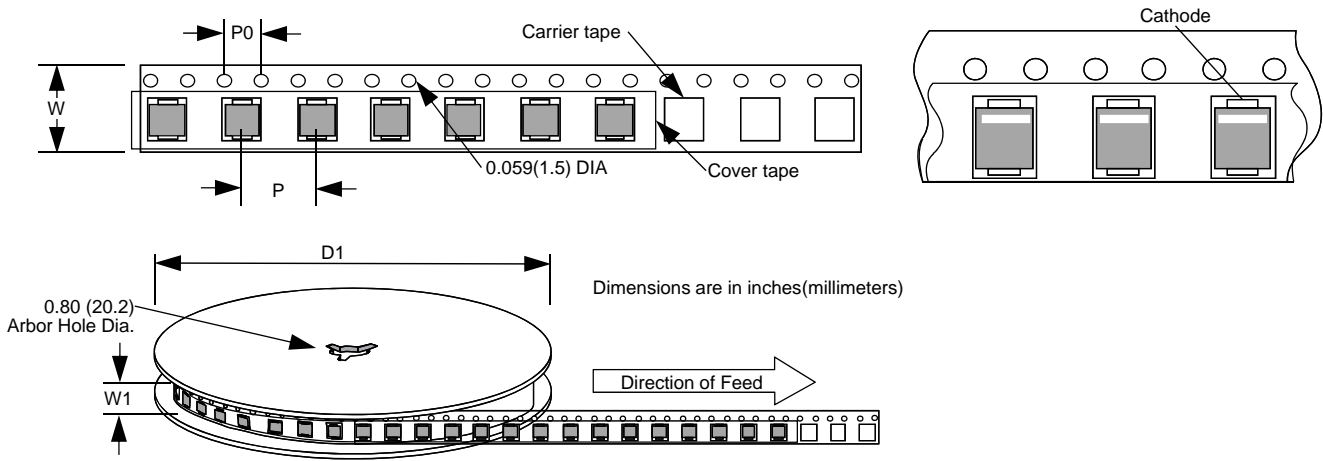

Fig. 4- Typical Junction Capacitance



## 1500W Surface Mount Transient Voltage Suppressors

### Reel and Tape



Dimension	Inches			Millimeters		
	MIN	NOM	MAX	MIN	NOM	MAX
P		0.315			8	
P0		0.157			4	
W		0.63			16	
W1		0.646			16.4	
D1		13			330.2	

### Packing Options

Package	Packing Description	Packing Quantity
SMC	Tape/Reel, 13" reel	3000



## 1500W Surface Mount Transient Voltage Suppressors

### Soldering Parameters

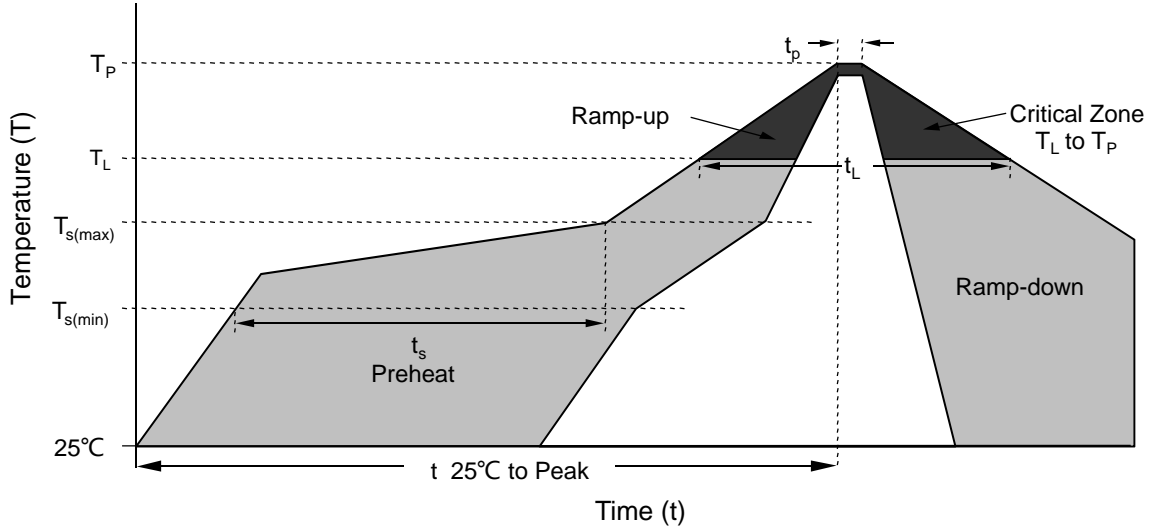

Reflow Condition		Lead-free assembly
Pre Heat	- Temperature Min ( $T_{s(min)}$ )	150°C
	- Temperature Max ( $T_{s(max)}$ )	200°C
	- Time (min to max) ( $t_s$ )	60 – 180 secs
Average ramp up rate (Liquidus Temp ( $T_L$ ) to peak)		3°C/second max
$T_{s(max)}$ to $T_L$ - Ramp-up Rate		3°C/second max
Reflow	- Temperature ( $T_L$ ) (Liquidus)	217°C
	- Time ( $t_L$ )	60 – 150 secs
Peak Temperature ( $T_P$ )		260 <sup>+0/-5</sup> °C
Time within 5°C of actual peak Temperature ( $t_p$ )		20 – 40 secs
Ramp-down Rate		6°C/second max
Time 25°C to peak Temperature (t)		8 minutes Max.
Do not exceed		260°C