

Features

- Low gate charge
- Low C_{rss} (typ 9pF)
- Fast switchin
- 100% avalanche tested
- Improved dv/dt capability
- RoHS product

Applications

- High frequency switching mode power supply
- Electronic ballast
- UPS

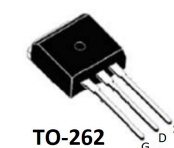
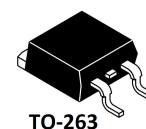
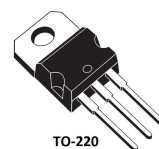
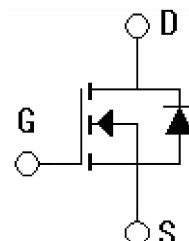

Absolute Ratings (Tc=25°C)

Parameter	Symbol	Value	Unit
Drain-Source Voltage	V_{DSS}	1000	V
Drain Current-continuous	I_D T=25°C T=100°C	8	A
		5	A
Drain Current-pulse (note 1)	I_{DM}	32*	A
Gate-Source Voltage	V_{GS}	±30	V
Single pulse avalanche energy(note 2)	E_{AS}	650	mJ
Avalanche Current (note 1)	I_{AR}	8	A
Repetitive Avalanche Energy(note 1)	E_{AR}	16.7	mJ
Power Dissipation (TO-263\TO-262\TO-220)	PD TC=25°C Derate above 25°C	167	W
		1.43	W/°C
Power Dissipation (TO-220F)	PD TC=25°C Derate above 25°C	31.7	W
		0.25	W/°C
Operating and Storage Temperature Range	T_J, T_{STG}	-55~+150	°C
Peak Diode Recovery dv/dt (note 3)	dv/dt	4.5	V/ns
Maximum Lead Temperature for Soldering Purposes	T_L	300	°C

*Drain current limited by maximum junction temperature

Electrical Characteristics($T_{CASE}=25^{\circ}C$ unless otherwise specified)

Parameter	Symbol	Tests conditions	Min	Type	Max	Units
Drain-Source Voltage	BV_{DSS}	$I_D=250\mu A, V_{GS}=0V$	1000	-	-	V
Breakdown Voltage Temperature Coefficient	$\Delta BV_{DSS}/\Delta T_J$	$I_D=250\mu A$, referenced to $25^{\circ}C$	-	1.05	-	$V/^{\circ}C$
Zero Gate Voltage Drain Current	I_{DSS}	$V_{DS}=1000V, V_{GS}=0V, T_C=25^{\circ}C$	-	-	1	μA
		$V_{DS}=800V, T_C=125^{\circ}C$	-	-	10	μA
Gate body leakage current	I_{GSS}	$V_{DS}=0V, V_{GS}=\pm 30V$	-	-	± 100	nA
On-Characteristics						
Gate Threshold Voltage	$V_{GS(th)}$	$V_{DS}=V_{GS}, I_D=250\mu A$	3.0	-	5.0	V
Static Drain-Source On-Resistance	$R_{DS(ON)}$	$V_{GS}=10V, I_D=4A$	-	1.8	2	Ω
Forward Transconductance	g_{FS}	$V_{DS}=40V, I_D=4A$ (note 4)	-	5.6	-	S
Dynamic Characteristics						
Input capacitance	C_{iss}	$V_{DS}=25V, V_{GS}=0V, f=1.0MHZ$	-	1320	1716	pF
Output capacitance	C_{oss}		-	105	136	pF
Reverse transfer capacitance	C_{rss}		-	9	12	pF

Electrical Characteristics($T_{CASE}=25^{\circ}C$ unless otherwise specified)

Parameter	Symbol	Tests conditions	Min	Type	Max	Units
Switching-Characteristics						
Turn-On delay time	$t_{d(on)}$	$V_{DD}=500V, I_D=8A, R_{GEN}=25\Omega$ (note 4,5)	-	34	75	ns
Turn-On rise time	t_r		-	85	155	ns
Turn-Off delay time	$t_{d(off)}$		-	56	113	ns
Turn-Off rise time	t_f		-	59	118	ns
Total Gate Charge	Q_g	$V_{DS}=800V, I_D=8A, V_{GS}=10V$ (note 4,5)	-	14	19	nC
Gate-Source charge	Q_{gs}		-	2.0	-	nC
Gate-Drain charge	Q_{gd}		-	7.0	-	nC

Drain-Source Diode Characteristics and Maximum Ratings						
Diode Forward Voltage (note 3)	V_{SD}	$V_{GS}=0V, I_S=8A$	-	-	1.4	V
Maximum Pulsed Drain-Source Diode Forward Current	I_{SM}	-	-	-	24	A
Maximum Continuous Drain Source Diode Forward Current	I_S	-	-	-	8	A
Reverse recovery time	t_{rr}	$V_{GS}=0V,$	-	625	-	ns
Reverse recovery charge	Q_{rr}	$I_S=8A \text{ di}/dt=100A/\mu s$ (note 4)	-	6.71	-	μC

Thermal Characteristic

Parameter	Symbol	Value		Unit
		TO-262/TO-263	TO-220F	
Thermal Resistance, junction to Case	$R_{th(j-C)}$	0.78	3.94	$^{\circ}C/W$
Thermal Resistance, Junction to Ambient	$R_{th(j-A)}$	62.5	80	$^{\circ}C/W$

Order Message

Marking	Package
MS8N100FE	TO-263
MS8N100FK	TO-262
MS8N100FS	TO-220F
MS8N100FT	TO-220

Notes:

1. Pulse width limited by maximum junction temperature
2. $L=33.0mH, I_{AS}=8A, V_{DD}=50V, R_G=25 \Omega, \text{Starting } T_J=25^{\circ}C$
3. $I_{SD} \leq 8A, di/dt \leq 200A/\mu s, V_{DD} \leq BV_{DSS}, \text{Starting } T_J=25^{\circ}C$
4. Pulse Test: Pulse Width $\leq 300\mu s, \text{Duty Cycle} \leq 2\%$
5. Essentially independent of operating temperature

ELECTRICAL CHARACTERISTICS (curves)

On-Region Characteristics

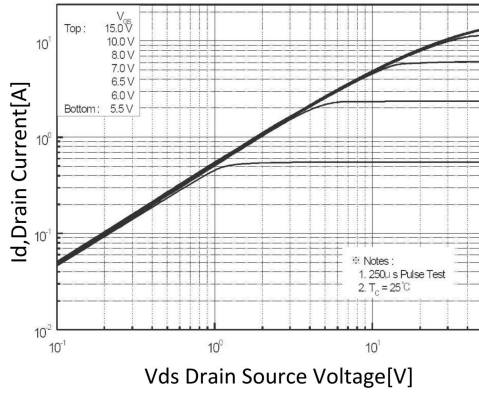

Transfer Characteristics

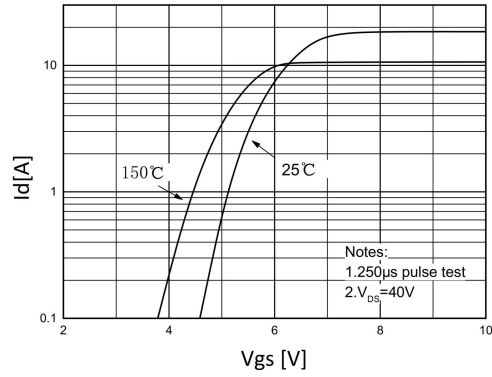

On-Resistance Variation vs. Drain Current and Gate Voltage

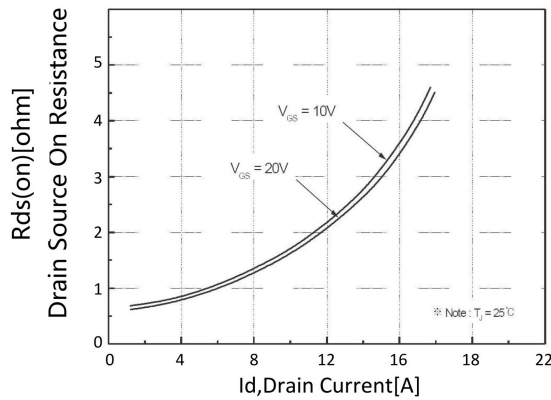

Body Diode Forward Voltage Variation vs. Source Current and Temperature

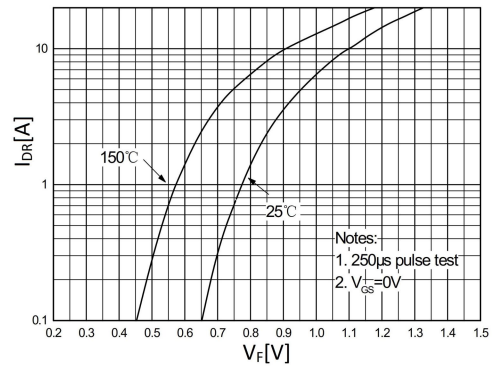

Capacitance Characteristics

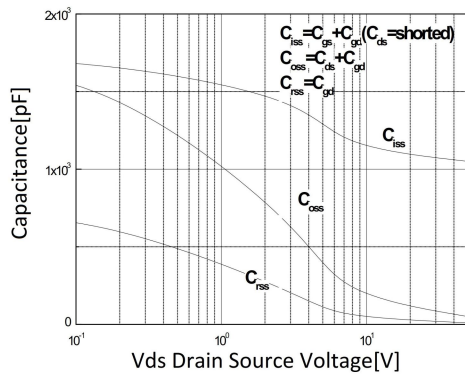

Gate Charge Characteristics

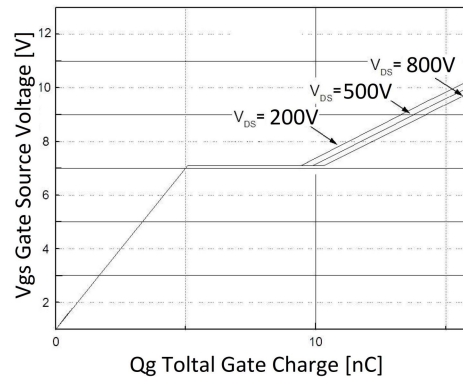

Breakdown Voltage Variation vs. Temperature

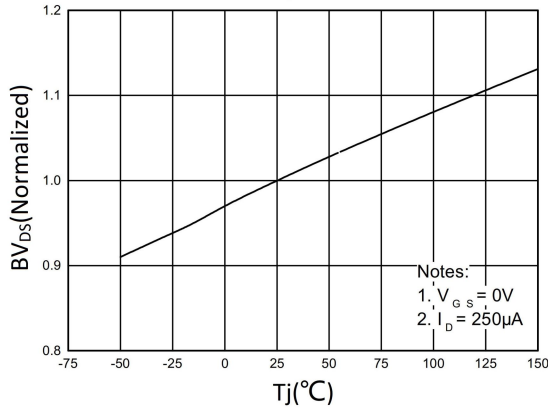

On-Resistance Variation vs. Temperature

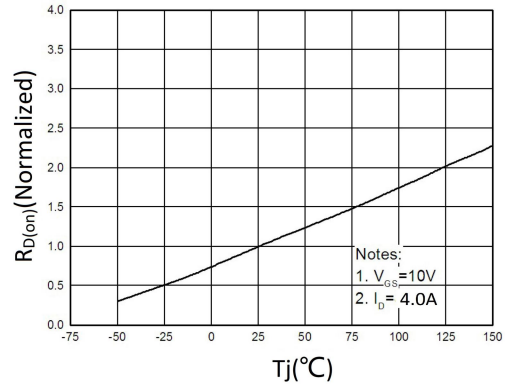

Maximum Safe Operating Area

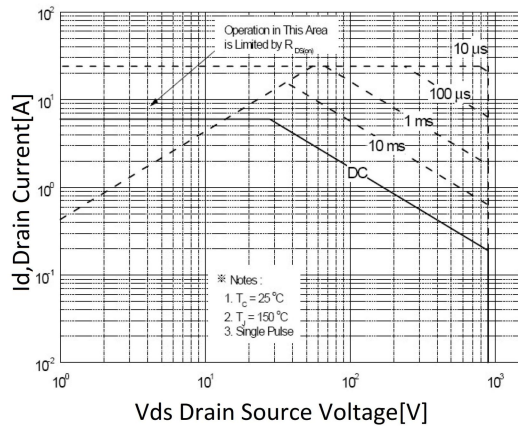

Maximum Drain Current vs. Case Temperature

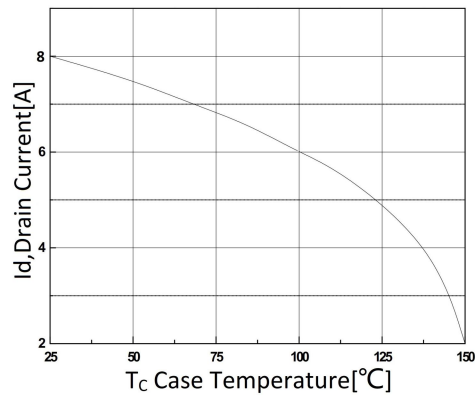

Transient Thermal Response Curve

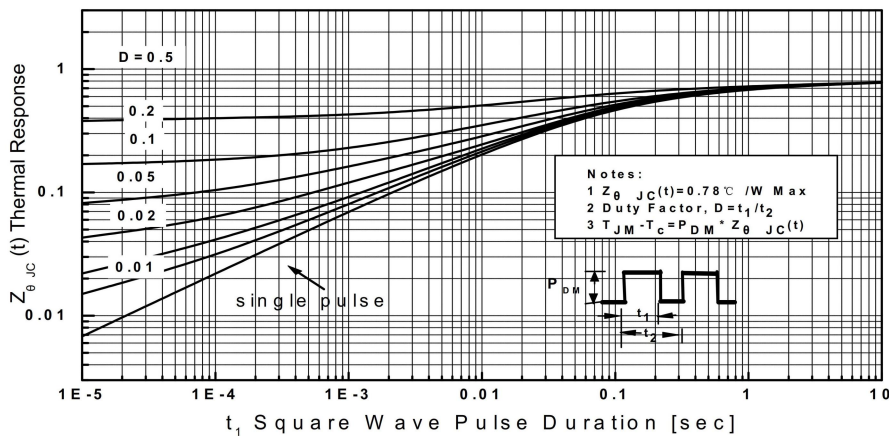

PACKAGE MECHANICAL DATA

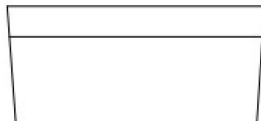
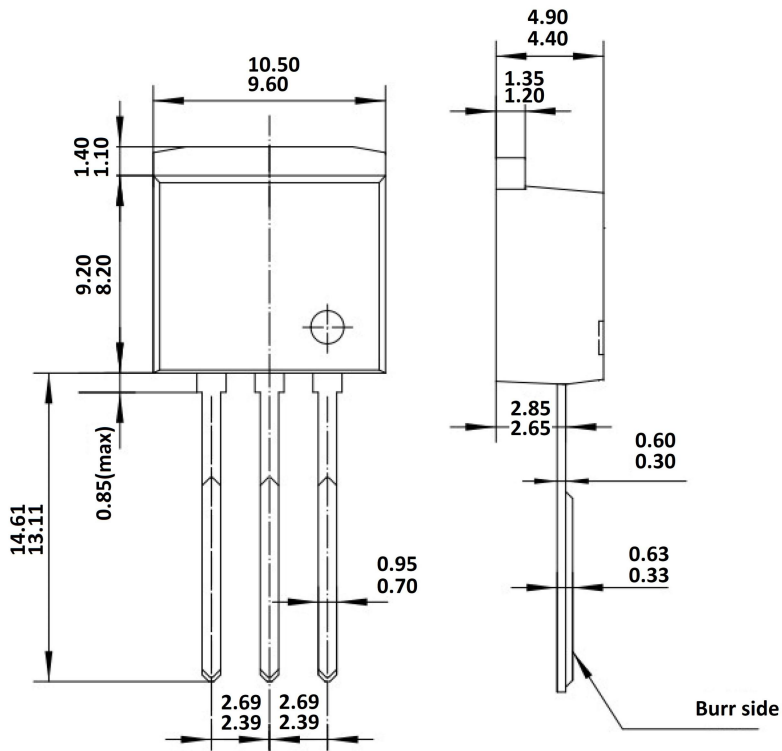
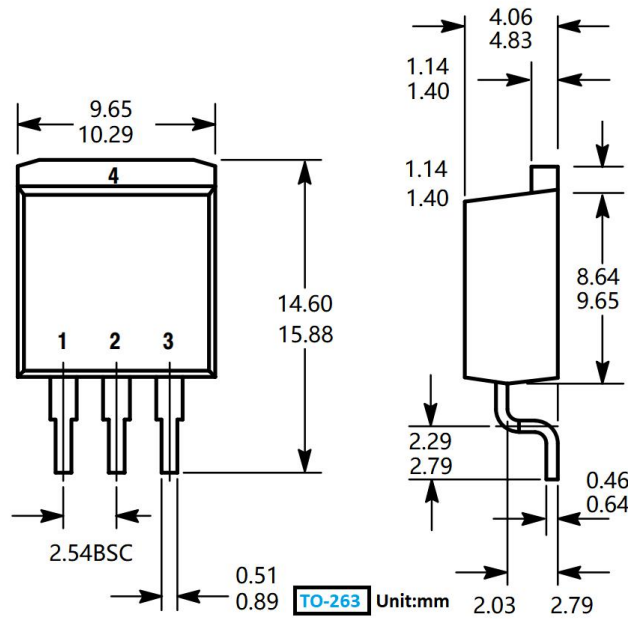

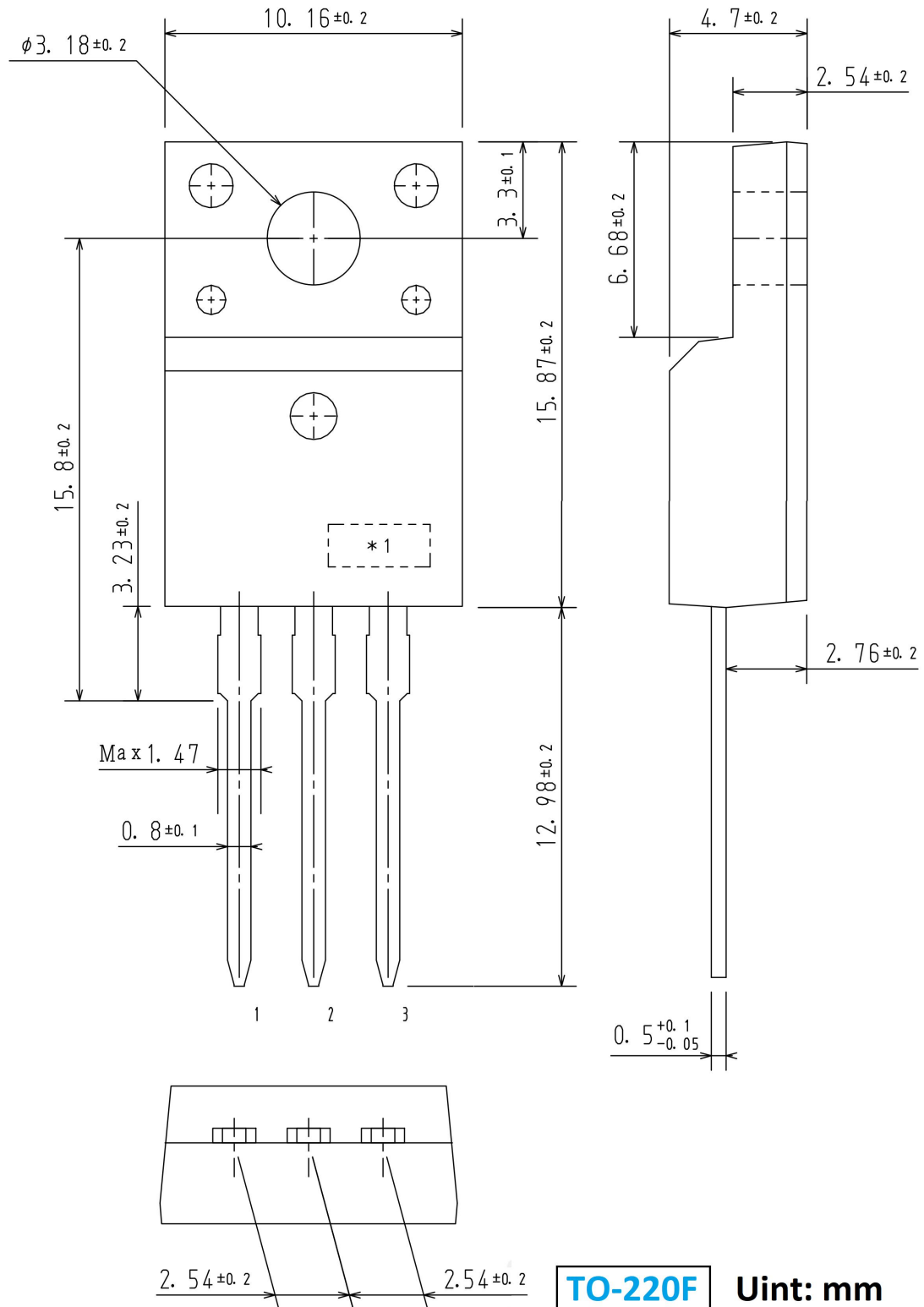

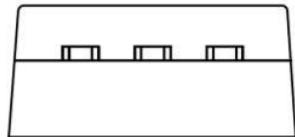
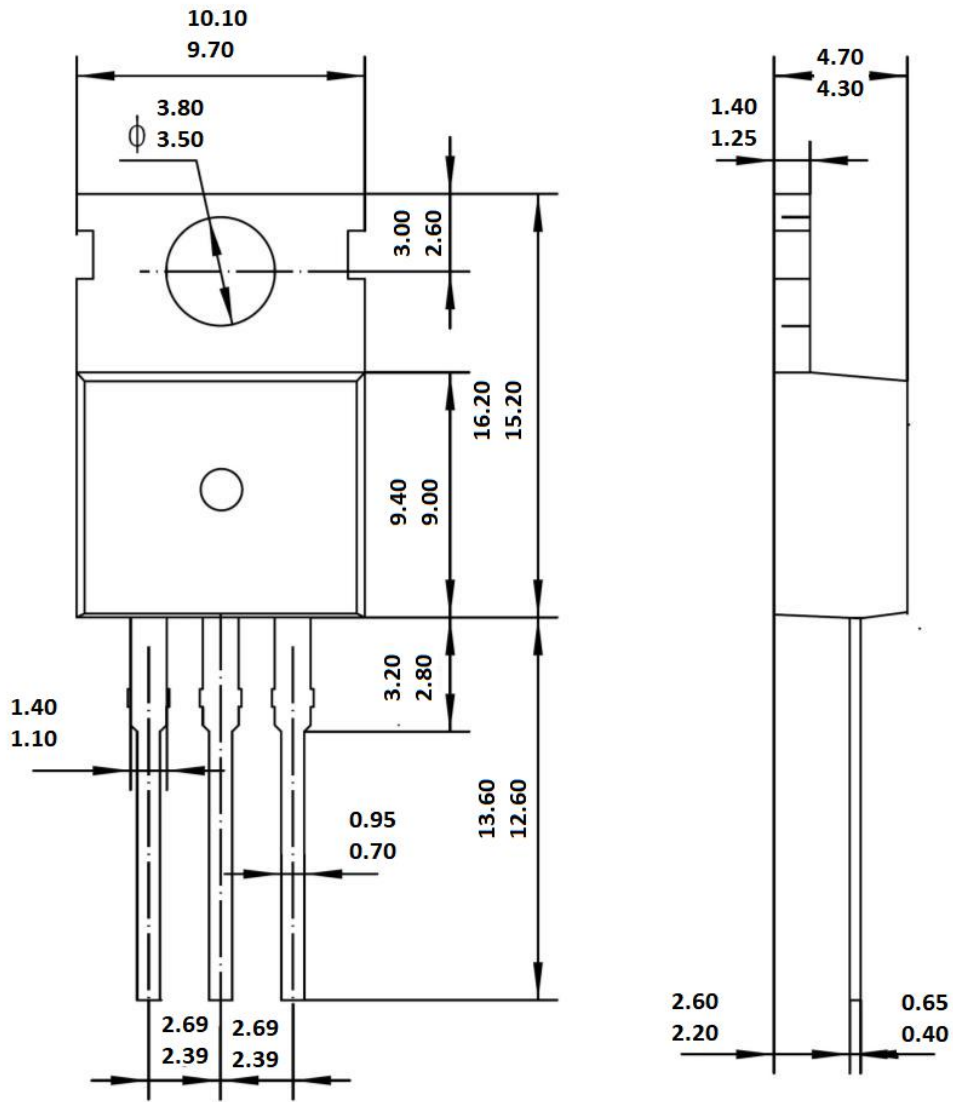

TO-220

Unit: mm