

4

3

2

1

THIS DRAWING IS UNPUBLISHED. RELEASED FOR PUBLICATION
COPYRIGHT BY TYCO ELECTRONICS CORPORATION. ALL RIGHTS RESERVED.

LOC	DIST	REVISIONS					
		P	LTR	DESCRIPTION	DATE	DWN	APVD
DS	-			RELEASED<FC00-0142-03>	06/OCT/'03	YD.	CS
			A	REVISED <ECR-05-004668>	13/JUN/'05	CH	CS
			A1	REVISED <ECR-07-005250>	12/JAN/'11	SJ	HG

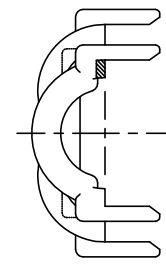
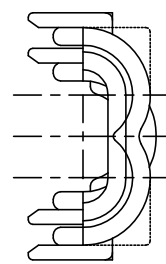
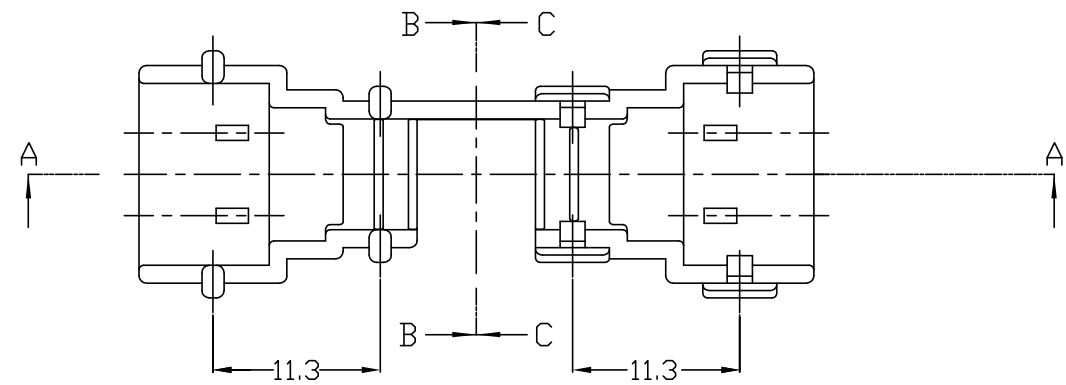

B-B

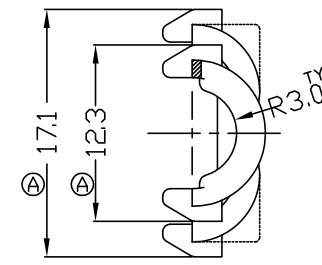

C-C

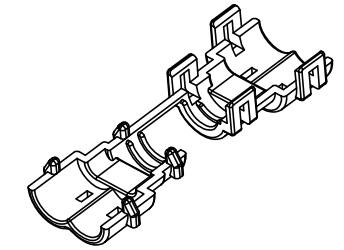

3D VIEW<SCALE 1:1>

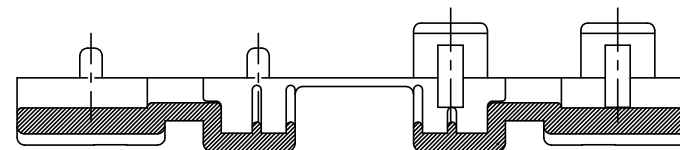
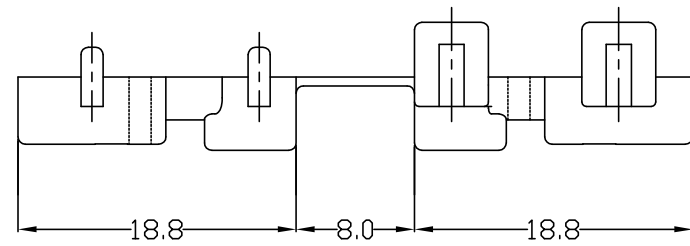

A-A

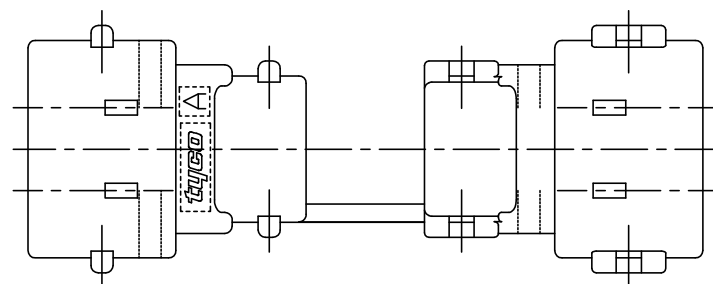

NOTE

- 1. APPLICABLE CORRUGATOR DIAMETER : $\phi 5.0$
- 2. APPLICABLE CAP ASS'Y P/N : 936291-2
PLUG ASS'Y P/N : 936248-2
- ①3. APPLICATION TEST SPEC: MS210-06C(EXCEPT 4.4)

BLACK	PA66	936311-1
COLOR	MATERIAL	P/N

THIS DRAWING IS A CONTROLLED DOCUMENT FOR TYCO ELECTRONICS CORPORATION IT IS SUBJECT TO CHANGE AND THE CONTROLLING ENGINEERING ORGANIZATION SHOULD BE CONTACTED FOR THE LATEST REVISION.		DWN: SJ CHOI		Tyco Electronics Kyungsan, Korea	
DIMENSIONS: mm		CHK: JW JUNG			
TOLERANCES UNLESS OTHERWISE SPECIFIED: 0 <XX<10 ± 0.2 10<XX<30 ± 0.25 30<XX ± 0.3 ANGLES ± 3°		APVD: HG CHD		NAME	
3rd ANGLE PROJECTION		PRODUCT SPEC		COVER HSG FOR .090 SEALED 2P PLUG CONN'R	
		APPLICATION SPEC		RESTRICTED TO	
MATERIAL SEE TABLE		COLOR SEE TABLE		SIZE CAGE CODE DRAWING NO A3 00779 C- 936311	
		WEIGHT		CUSTOMER DRAWING	
				SCALE 2/1 SHEET 1 OF 1 REV A1	