

瓷片電容器產品承認書

APPROVAL SPECIFICATIONS FOR DISC CERAMIC CAPACITORS

客戶 CUSTOMER	立創商城		
客戶料號 CUSTOMER P/N	C3148289		
產品編碼 PART NUMBER	2H471KC1F-B4-ZNR		
規格描述 DESCRIPTION	500V/471/K/F5.08/L18/Y5P/ZNR		
日期 DATE	2022-07-05	文件編號 DOC. NO.	DEC-WD-WI001(C)

德爾創承認欄 APPROVED BY DERSONIC			客戶承認欄 APPROVED BY CUSTOMER	
批 準 APPROVED BY	審 核 CHECK BY	制 訂 FORMULATE BY	批 準 APPROVED BY	審 核 CHECK BY
彭少雄	吳成愛 承認專用章	陳冬花		

東莞市德爾創電子有限公司

DONGGUAN CITY DERSONIC ELECTRONICS CO., LTD.

廣東省東莞市長安鎮錦廈河南工業區錦平路 5 號

NO.5, JINGPING ROAD, JINXIA HENAN INDUSTRIAL ZONE, CHANGAN TOWN DONGGUAN CITY, PRC

TEL: 86-769-8155 5686

FAX: 86-0769-8155 5989

WEBSITE: [HTTP://WWW.DERSONIC.COM](http://www.dersonic.com)

E-MAIL: SALES@DERSONIC.COM

目录 CONTENTS	数据表 DATA SHEET	3
	温度补偿型陶瓷电容器 TC TYPE CERAMIC CAPACITORS	4
	高介电常数型陶瓷电容器 HI-K TYPE CERAMIC CAPACITORS	6
	半导体型陶瓷电容器 SEMICONDUCTOR TYPE CERAMIC CAPACITORS	8
	低损耗型陶瓷电容器 LOW LOSS TYPE CERAMIC CAPACITORS	9
	标准与试验方法 SPECIFICATIONS AND TESTING METHODS	10
	包装 PACKAGING	12



請確保我們的產品安裝到您的產品上前，已根據您的需求進行了評估。

Please make sure that your product has been evaluated in view of your specifications with our product being mounted to your product.

請您在使用我們的產品時，不要偏離此標準。

You are requested not to use our product deviating from this specification.

数据表
DATA SHEET

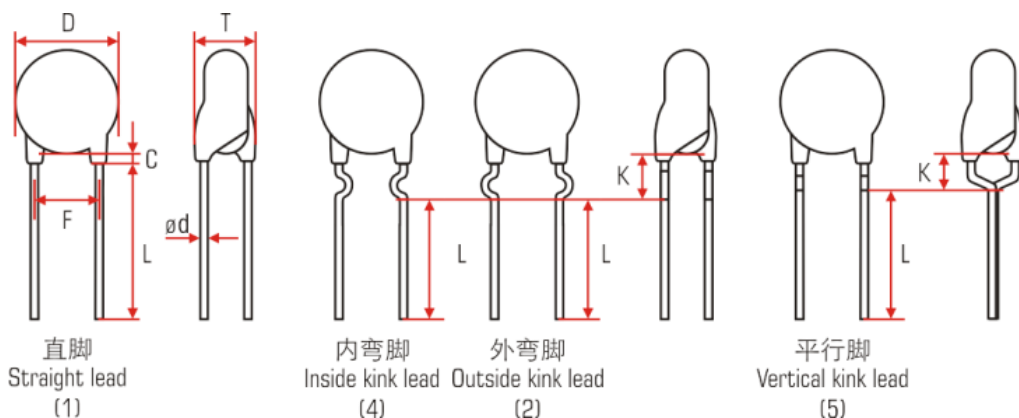

产品编码 Part number	2H471KC1F-B4-ZNR	
规格描述 Description	500V/471/K/F5.08/L18/Y5P/ZNR	
客户料号 Customer P/N		
介质类别 Dielectric class	Class 2	
额定电压 Rated voltage	500VDC	
电容量 Capacitance	470pF ± 10% @ 1kHz 1Vrms 25°C	
损耗角正切 Tangent of loss angle	0.025 max @ 1kHz 1Vrms 25°C	
耐电压 Testing voltage	1250VDC (Charge/discharge current 2mA max) 3s PASS	
绝缘电阻 Insulation resistance	6GΩ min @ 500V 60s, RH < 70%	
温度特性 Temperature characteristics	Y5P ΔC/C: ± 10% (85°C to 125°C: +10%/-40%) @ -25°C~125°C	
尺寸 DIMENSIONS	D (Diameter)	5.4mm ± 0.8mm
	T (Thickness)	2.8mm ± 0.6mm
	F (Lead spacing)	5.08mm ± 0.8mm
	L (Lead length)	18mm ± 4.0mm
	ød (Lead diameter)	0.55mm max
	C (Kink height)	2.0mm max
标志 Marking	ZNR 471 500V	

温度补偿型陶瓷电容器 TC TYPE CERAMIC CAPACITORS

特点 FEATURES

- 符合IEC 60384-8标准
Comply with IEC 60384-8 standards
- 温度系数呈线性
Linear temperature coefficient of capacitance
- 电容量稳定性高
High stability of capacitance
- 应用频率范围广，损耗低
Low loss at wide range of frequency
- 符合RoHS 2.0的要求
RoHS 2.0 complied

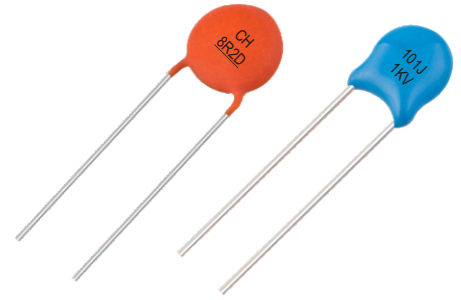

用途 APPLICATIONS

- 谐振电路
Resonant circuit
- 高Q值需求电路
High Q value requirement
- 电容量高稳定性电路
High stability capacitance characteristics

特性 CHARACTERISTICS

工作温度范围 Operating temperature range	-25°C ~ +125°C
电容量 Capacitance (C ₀)	0.5pF ~ 1 000pF 在25±1°C下使用1MHz(100kHz)、1.0Vrms进行测量，在允许偏差范围内。 Measured at 1MHz(100kHz), 1.0Vrms and 25°C ±1°C, within the specified tolerance.
Q值 Q value	< 30pF: Q ≥ 400 + 20C ₀ ≥ 30pF: Q ≥ 1000 Q = 1/tanδ
额定电压 Rated voltage (U ₀), DC	50V ~ 6 300V 在两导线间施加下列电压，时间1s~5s(充/放电电流小于50mA)无异常： The capacitor should not be damaged when the following voltage is applied between the lead wires for 1 to 5 sec (Charge / discharge current 50mA max). < 630V, 2.5U ₀ ≥ 630V, 1.5U ₀ + 500V
绝缘电阻 Insulation resistance (IR)	10 000MΩ min 在两导线间施加额定电压（额定电压大于500V时，使用500V）进行测量，时间1分钟 The insulation resistance should be measured with a DC voltage not exceeding the rated voltage (above 500V rated voltage tested by 500V) at normal temperature and humidity and 1 min. of charging
温度系数 Temperature coefficient	NPO, N750, SL, N3300 etc.

■ 典型温度系数曲线 Typical temperature coefficient curves

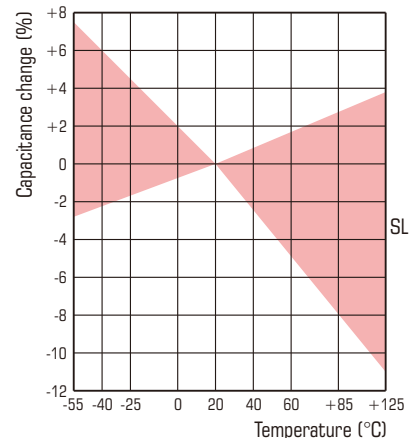
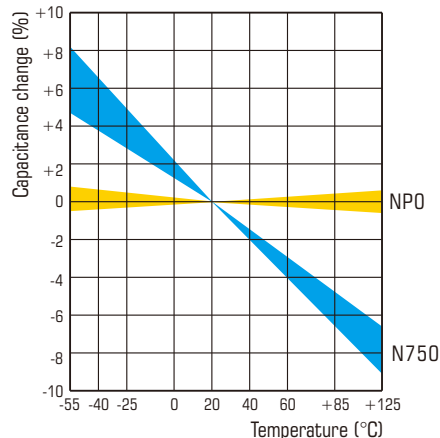

温度补偿型陶瓷电容器 TC TYPE CERAMIC CAPACITORS



— 德信立業 創新開拓 —

规格表 SPECIFICATIONS LIST

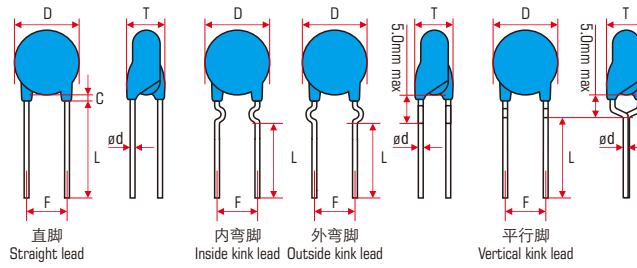

C: <500VDC: 1.5mm max
≥500VDC: 3.0mm max
包封层:
Coating:
<500VDC: 酚醛树脂
Phenolic resin
≥500VDC: 环氧树脂
Epoxy resin
导线: CP线
Lead wire: CP wire

额定电压, DC Rated voltage, DC	50V (1H)				500V (2H)				1kV (3A)				2kV (3D) 3.15kV (3F)				4kV (3G)	6.3kV (3J)
	NPO (CH)	N750 (UJ)	SL (SL)	N3300 (DL)	NPO (CH)	N750 (UJ)	SL (SL)	N3300 (DL)	NPO (CH)	N750 (UJ)	SL (SL)	N3300 (DL)	NPO (CH)	N750 (UJ)	SL (SL)	N3300 (DL)	SL (SL)	SL (SL)
温度系数 Temperature coefficient																		
容量(pF) Capacitance (pF)																		
误差 Tolerance																		
0.5 (0R5)	A				C				C				D					
1.0 (010)	A				C				C				D					
:	A				C				C				D					
9.1 (9R1)	A				C				C				D					
10 (100)	A				C				C				D				E	E
12 (120)	A				C				C				D				E	E
15 (150)	A	A			C	C			C	C			D	D			E	E
18 (180)	A	A			C	C			C	C			D	D			F	G
20 (200)	A	A			C	C			C	C			D	D			F	G
22 (220)	A	A			C	C			C	C			D	D			F	G
24 (240)	A	A			C	C			D	C			E	E			G	G
27 (270)	A	A			C	C			D	C			E	E			H	H
30 (300)	A	A			C	C			F	C			G	G	D		H	J
33 (330)	A	A			C	C			F	C			G	G	D		I	J
36 (360)	A	A			D	C			F	D			G	G	D		E	F
39 (390)	A	A			D	C			F	D			G	G	D		E	F
43 (430)	B	A			D	D			F	F			G	H	D		F	G
47 (470)	B	A			D	D			F	F			H	H	D		F	G
51 (510)	C	A			D	E	C		G	F	C		J	J	D		F	G
56 (560)	C	A			D	E	C		G	F	C		J	J	D		G	H
62 (620)	C	C	A		G	E	C		G	H	C		J	F			G	H
68 (680)	C	C	A		G	E	C		G	H	C		J	F			H	I
75 (750)	C	C	A		G	G	C		G	J	E		K	H			I	J
82 (820)	C	C	A		G	G	C		G	J	E		K	H			I	J
91 (910)	D	D	A		H	G	C		H	J	E		K	H			K	L
100 (101)	D	D	A		H	G	C		H	J	E		K	H			K	L
120 (121)	E	A			I	D			I	J	E		K	J	D		L	L
150 (151)	E	B			I	D			I	J	E		K	J	D		L	L
180 (181)	H	B			K	F	C		I	J	E		K	K	F		L	L
200 (201)	H	B	B		K	F	C		I	J	E		K	K	F		L	L
220 (221)	H	B	B		K	F	C		I	J	E		K	K	F		L	L
240 (241)	I	D	B		G	C			J	J	E		L	L	F		L	L
270 (271)	J	E	B		H	C			J	J	E		L	L	F		L	L
300 (301)	J	F	B		I	C			J	J	E		L	L	F		L	L
330 (331)	J	F	B		I	C			J	J	E		L	L	F		L	L
360 (361)	J	F	B		I	D			J	J	E		L	L	F		L	L
390 (391)	J	F	B		I	D			J	J	E		L	L	F		L	L
430 (431)		G	B		J	D			K				J	J			L	L
470 (471)		H	B		J	D			K				J	J			L	L
510 (511)		I	C			E							J	J			L	L
560 (561)		I	C			E							J	J			L	L
680 (681)		J	E			F							I				L	L
820 (821)		K	E			H							K				L	L
1000 (102)		L	E			H							K				L	L
1200 (122)		L	E			H							K				L	L
T, mm max	3.0				3.5				4.0				4.0				4.5	5.0
F, mm±0.8mm	2.5 / 5.0				5.0				5.0				5.0 / 7.5				7.5	10.0
ød, mm±0.05mm	0.40				0.45				0.45				0.50				0.55	0.55
L, mm min	13.0				18.0				18.0				20.0				20.0	20.0

→ 最大直径代码, 具体见下表
Maximum diameter code, see the table below

最大直径代码表 Maximum diameter code sheet

代码 Code	A	B	C	D	E	F	G	H	I	J	K	L	M	N	O	P	Q
D, mm max	5.0	5.5	6.0	6.5	7.0	7.5	8.0	8.5	9.0	10.0	11.0	12.0	13.0	14.0	15.0	16.0	18.0

备注: 所有的尺寸规格均可以定制, 但需要向我公司业务咨询。
Note: All dimensions can be customized, but you need to consult with our sales staff.

高介电常数型陶瓷电容器 HI-K TYPE CERAMIC CAPACITORS

特点 FEATURES

- 符合IEC 60384-9的要求
Comply with IEC 60384-9 standards
- 非线性温度特性
Nonlinear temperature coefficient of capacitance
- 小尺寸大容量
Large capacitance in small sizes
- 符合RoHS 2.0的要求
RoHS 2.0 complied

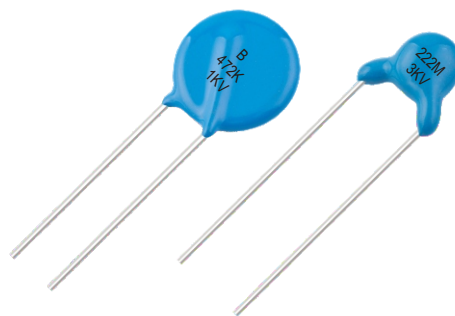

用途 APPLICATIONS

- 旁路和耦合电路
By-pass and coupling
- 对电容量稳定性和损耗要求不高的电路
Frequency discriminating circuits where Q and stability of capacitance characteristic are not major importance

特性 CHARACTERISTICS

工作温度范围 Operating temperature range	-25°C ~ +85°C
电容量 Capacitance (C _r)	100pF ~ 0.1μF (100 000pF) 在25±1°C下使用1kHz、1.0Vrms进行测量，在允许偏差范围内。 Measured at 1kHz, 1.0Vrms and 25±1°C, within the specified tolerance.
损耗角正切 Tangent of loss angle (tanδ)	0.035 max
额定电压 Rated voltage (U _r),DC	50V ~ 6 300V 在两导线间施加下列电压，时间1s~5s(充/放电电流小于50mA)无异常： The capacitor should not be damaged when the following voltage is applied between the lead wires for 1 to 5 sec (Charge / discharge current 50mA max). < 630V, 2.5U _r ≥ 630V, 1.5U _r + 500V
绝缘电阻 Insulation resistance (IR)	6 000MΩ min 在两导线间施加额定电压（额定电压大于500V时，使用500V）进行测量，时间1分钟 The insulation resistance should be measured with a DC voltage not exceeding the rated voltage (above 500V rated voltage tested by 500V) at normal temperature and humidity and 1 min. of charging
温度特性 Temperature characteristic	Y5P, Y5U, Y5V etc.

- 典型温度特性曲线
Typical temperature characteristic curves



高介电常数型陶瓷电容器 HI-K TYPE CERAMIC CAPACITORS



— 德信立業 創新開拓 —

规格表 SPECIFICATIONS LIST

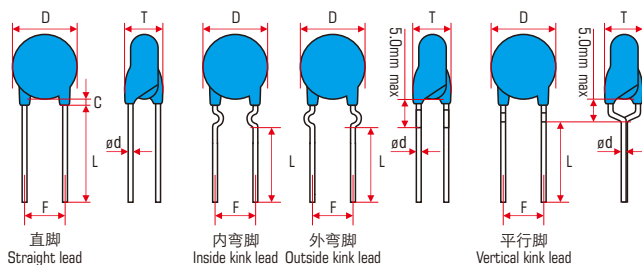

C:
 < 500VDC: 1.5mm max
 ≥ 500VDC: 3.0mm max
 包封层:
 Coating:
 < 500VDC: 酚醛树脂
 Phenolic resin
 ≥ 500VDC: 环氧树脂
 Epoxy resin
 导线: CP线
 Lead wire: CP wire

额定电压, DC Rated voltage, DC	50V (1H)			500V (2H)			1kV (3A)			2kV (3D)			3.15kV (3F)			4kV (3G)			6.3kV (3J)				
温度特性 Temp. characteristic	Y5P (B4)	Y5U (E4)	Y5V (F4)	Y5P (B4)	Y5U (E4)	Y5V (F4)	Y5P (B4)	Y5U (E4)	Y5V (F4)	Y5P (B4)	Y5U (E4)	Y5V (F4)	Y5P (B4)	Y5U (E4)	Y5V (F4)	Y5P (B4)	Y5U (E4)	Y5V (F4)	Y5P (B4)	Y5U (E4)	Y5V (F4)		
容量(pF) Capacitance (pF)																							
100 (101)																							
120 (121)																							
150 (151)																							
180 (181)																							
220 (221)	B			C																			
270 (271)	B			C																			
330 (331)	B			C																			
390 (391)	B			C																			
470 (471)	B			C																			
560 (561)	B			C																			
680 (681)	B			C																			
820 (821)	B			C																			
1000 (102)	B			C	C																		
1200 (122)	B			D	C																		
1500 (152)	B			E	C																		
1800 (182)	B			F	C																		
2200 (222)	B	B		G	C	C																	
2700 (272)	D	B		H	C	C																	
3300 (332)	D	B		J	C	C																	
3900 (392)	E	B		J	E	E																	
4700 (472)	F	B		K	G	E																	
5600 (562)	G	C		L	H	E																	
6800 (682)	I	D		B	H	G																	
8200 (822)	K	D		B	J	I																	
10000 (103)	K	D		O	K	I																	
15000 (153)	H	F		M	M	L																	
22000 (223)	K	H		O	L	L																	
33000 (333)	K	K		K	O	L																	
47000 (473)			M			O																	
68000 (683)						Q																	
100000 (104)						Q																	
150000 (154)						Q																	
误差 Tolerance	±10% (K)	±20% (M)		±10% (K)	±20% (M)	±10% (K)	±20% (M)	±10% (K)	±20% (M)	±10% (K)	±20% (M)	±10% (K)	±20% (M)	±10% (K)	±20% (M)	±10% (K)	±20% (M)	±10% (K)	±20% (M)	±10% (K)	±20% (M)	±10% (K)	±20% (M)
T, mm max	3.0			3.5			4.0			4.5			4.5			5.0			5.5				
F, mm±0.8mm	2.5 / 5.0			5.0			5.0 / 7.5			5.0 / 7.5			5.0 / 7.5			7.5			10.0				
ød, mm±0.05mm	0.40			0.45			0.45			0.50			0.50			0.55			0.55				
L, mm min	13.0			18.0			18.0			20.0			20.0			20.0			20.0				

最大直径代码表
Maximum diameter code sheet

代码 Code	B	C	D	E	F	G	H	I	J	K	L	M	N	O	P	Q	R
D, mm max	5.5	6.0	6.5	7.0	7.5	8.0	8.5	9.0	10.0	11.0	12.0	13.0	14.0	15.0	16.0	18.0	20.0

备注: 所有的尺寸规格均可以定制, 但需要向我公司业务咨询。
Note: All dimensions can be customized, but you need to consult with our sales staff.

半导体型陶瓷电容器 SEMICONDUCTOR TYPE CERAMIC CAPACITORS



— 德信立業 創新開拓 —

特点 FEATURES

- 介质表面绝缘
Dielectric surface layer insulation
- 非线性温度特性
Non linear temperature coefficient of capacitance
- 小尺寸大容量
Large capacitance in small sizes
- 符合RoHS 2.0的要求
RoHS 2.0 complied

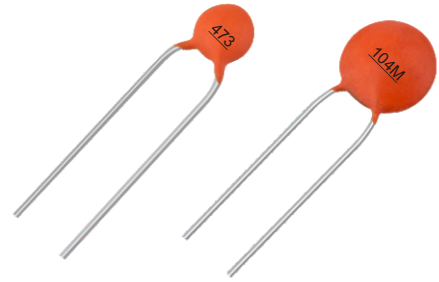

用途 APPLICATIONS

- 晶体管化
Transistorized
- 低压旁路、耦合电路
Low voltage electronic circuits for by-pass, coupling
- 可使用在对容量稳定性、绝缘电阻与损耗要求不高的电路
Frequency determination, in which dielectric losses, Hi-IR and capacitance stability are not major importance

特性 CHARACTERISTICS

工作温度范围 Operating temperature range	-25°C ~ +85°C
电容量 Capacitance (C ₀)	4700pF to 0.47μF 在25±1°C下使用1KHz、0.1Vrms进行测量，在允许偏差范围内 Measured at 1kHz, 0.1Vrms and 25±1°C, within the specified tolerance
损耗角正切 Tangent of loss angle	tanδ: 0.050 max
额定电压 Rated Voltage (U _r), DC	16V to 100V 在两导线间施加1.5倍额定电压，时间1s到5s（充/放电流小于50mA） The capacitor should not be damaged when 1.5 times rated voltage is applied between the lead wires for 1 to 5 sec (Charge / discharge current 50mA max).
绝缘电阻 Insulation resistance	> 1 000MΩ or 25ΩF（取较小值， whichever is smaller） 在两导线间施加额定电压进行测量，时间1分钟 The insulation resistance should be measured with a DC voltage not exceeding the rated voltage at normal temperature and humidity and 1 min. of charging
温度特性 Temperature characteristic	Y5P, Y5U, Y5V

规格表 SPECIFICATIONS LIST

温度特性 Temp. characteristic	Y5P (3B)			Y5U (3E)			Y5V (3F)			
额定电压, DC Rated voltage, DC	16V (1B)	25V (1E)	50V (1H)/ 63V (1J)	16V (1B)	25V (1E)	50V (1H)/ 63V (1J)	16V (1B)	25V (1E)	50V (1H)/ 63V (1J)	100V (2A)
容量 (pF) Capacitance (pF)	4700 (472) 5600 (562) 6800 (682) 8200 (822)	B C C C	B C C C	B → 最大直径代码，具体见下表 Maximum diameter code, see the table below			B B B B	B B B B	B B B B	
10000 (103)	C	C	C	B	B	B			B	B
12000 (123)	C	C	C	B	B	B			B	B
15000 (153)	C	C	C	B	B	C			B	B
18000 (183)	E	E	E	B	C	C			B	B
22000 (223)	E	E	E	B	C	C	B	B	B	C
27000 (273)	E	E	G	B	C	C	B	B	B	C
33000 (333)	G	G	G	C	C	C	B	B	C	C
39000 (393)	G	G	I	C	C	E	B	C	C	C
47000 (473)	G	G	I	C	C	E	B	C	C	C
56000 (563)	I	I	I	E	E	E	C	C	D	E
68000 (683)	I	I	I	E	E	E	C	C	D	E
82000 (823)	J	J	J	E	G	G	C	C	D	E
100000 (104)	L	L	O	E	G	I	C	D	F	I
220000 (224)				J	J	L	J	J	L	M
330000 (334)							M	M		
470000 (474)							M	M		
误差 Tolerance	±10% (K)			±20% (M)			±20% (M)			

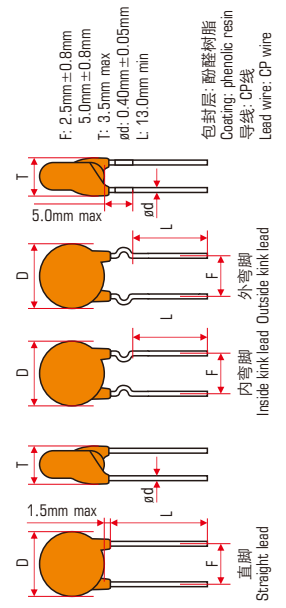

最大直径代码表
Maximum diameter code sheet

代码 Code	B	C	D	E	F	G	H	I	J	K	L	M	N	O	P	Q	R
D, mm max	5.5	6.0	6.5	7.0	7.5	8.0	8.5	9.0	10.0	11.0	12.0	13.0	14.0	15.0	16.0	18.0	20.0

备注：所有的尺寸规格均可以定制，但需要向我公司业务咨询。
Note: All dimensions can be customized, but you need to consult with our sales staff.

低损耗型陶瓷电容器 LOW LOSS TYPE CERAMIC CAPACITORS



— 德信立業 創新開拓 —

特点 FEATURES

- 高频特性好
Good high frequency characteristics
- 损耗小发热低
Low loss, less heat.
- 介质耐压强度高
High dielectric voltage withstanding strength.
- 有铅，但符合ROHS标准豁免条款
Have a lead, but comply with RoHS standard exemption clause.

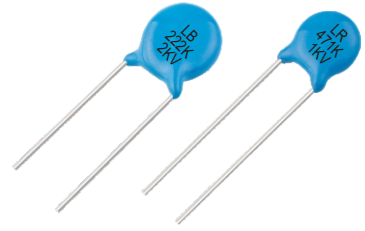

用途 APPLICATIONS

- 广泛使用于平板电视、监控电路、节能灯、电子整流器及其它高压高频电路
Widely used in FPTV, monitoring circuit, CFL, electronic ballast. and other high voltage, high frequency circuit.

特性 CHARACTERISTICS

工作温度范围 Operating temperature range	-25°C ~ +125°C
电容量 Capacitance (C ₀)	100pF to 0.01μF 在25±1°C下使用1KHz、1.0Vrms进行测量，在允许偏差范围内 Measured at 1kHz, 1.0Vrms and 25±1°C, within the specified tolerance
损耗角正切 Tangent of loss angle	Y5P (Bn), tanδ: 0.005 max; Y5R, tanδ: 0.002 max.
额定电压 Rated Voltage (U _r),DC	500V to 6 300V 在两导线间施加1.5倍额定电压再加500V，时间1s到5s（充/放电流小于50mA） The capacitor should not be damaged when 1.5 times rated voltage plus 500V is applied between the lead wires for 1 to 5 sec (Charge / discharge current 50mA max).
绝缘电阻 Insulation resistance	10 000MΩ min 在两导线间施加500V进行测量，时间1分钟 The insulation resistance should be measured with 500V voltage at normal temperature and humidity and 1 min. of charging
温度特性 Temperature characteristic	Y5P(Bn), Y5R

规格表 SPECIFICATIONS LIST

温度特性 Temp. characteristic	Y5P (Bn)				Y5R (R4)		
	1kV (3A)	2kV (3D)	4kV (3G)	6.3kV (3J)	500V (2H)	1kV (3A)	2kV (3D)
容量(pF) Capacitance (pF)	100 (101) 120 (121) 150 (151) 180 (181)	E E	E E E	G G G		E	E
	220 (221) 270 (271) 330 (331) 390 (391)	E E E E	E E E E	G G G I	D	E E E	E E E F
	470 (471) 560 (561) 680 (681) 820 (821)	E E E E	E G H	I J K L	D E F	E G G I	G H I J
	1000 (102) 1500 (152) 2200 (222) 3300 (332)	F H J K	H J L O	L M O P	F H J L	I J M N	L M N P
	4700 (472) 5600 (562) 6800 (682) 10000 (103)	N P P R	P		M	P	T
误差 Tolerance	±10% (K)				±10% (K)		
T, mm max	4.0	4.5	5.0	5.5	3.5	4.0	4.5
F, mm±0.8mm	5.0	5.0 / 7.5	7.5	10.0	5.0	5.0	5.0 / 7.5
ød, mm±0.05mm	0.50	0.50	0.55	0.55	0.50	0.50	0.50

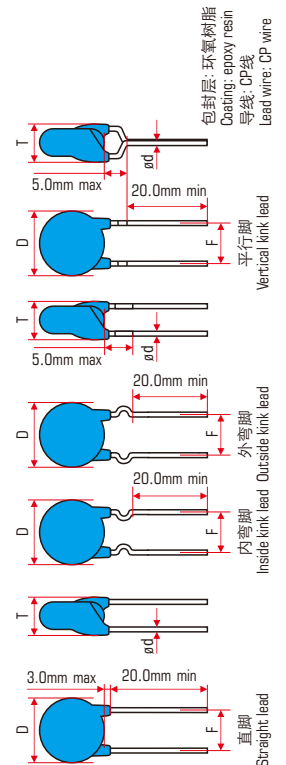

最大直径代码表
Maximum diameter code sheet

代码 Code	D	E	F	G	H	I	J	K	L	M	N	O	P	Q	R	S	T
D, mm max	6.5	7.0	7.5	8.0	8.5	9.0	10.0	11.0	12.0	13.0	14.0	15.0	16.0	18.0	20.0	22.0	25.0

备注：所有的尺寸规格均可以定制，但需要向我公司业务咨询。
Note: All dimensions can be customized, but you need to consult with our sales staff.

圆板陶瓷电容器试验方法

TESTING METHODS FOR DISC CERAMIC CAPACITORS



— 德信立業 創新開拓 —

标准与试验方法

SPECIFICATIONS AND TESTING METHODS

测量与试验前，请注意“测量与使用注意事项”中“测量”章节规定的内容。

Before measurement and testing, please note "MEASURING AND APPLICATION NOTICE" content "Measurement" of the provisions of section.

序 No.	试验项目 Item	标准 Specifications			试验方法 Testing methods												
		Class 1	Class 2 / Low-DF	Class 3													
1	外观与尺寸 Appearance (APP) and dimension	外观形状没有明显的缺点，尺寸在标准范围内。 No marked defect on appearance form and dimensions are within specified range.			电容必须用目视检查其明显的缺点。 The capacitor should be visually inspected for evidence of defect. 尺寸用游标卡尺测量。 Dimensions should be measured with slide calipers.												
2	标志 Marking	清晰易于识别。 To be easily legible			目视检查。 The capacitor should be visually inspected.												
3	容量 Capacitance (C _r)	在误差范围内。 Within specified tolerance			容量与损耗(tanδ或Q值)在25±1°C下，使用表1条件进行下测量。 The capacitance, loss (tanδ or Q value) should be measured at 25±1°C with test conditions of the table 1.												
4	损耗角正切 Tangent of loss angle (tanδ)	> 30pF, Q≥1000 ≤ 30pF, Q≥400+20×C _r Q=1/tanδ	Class 2: tanδ≤0.035 Low-DF Y5P: tanδ≤0.005 Y5R: tanδ≤0.002	tanδ≤0.035	表1 Table 1												
					<table border="1"> <thead> <tr> <th>类别 Type</th> <th>Class 1</th> <th>Class 2 / Low-DF</th> <th>Class 3</th> </tr> </thead> <tbody> <tr> <td>频率 Frequency</td> <td>1MHz(100KHz)</td> <td>1kHz</td> <td>1kHz</td> </tr> <tr> <td>电压 Voltage</td> <td>1.0Vrms</td> <td>1.0Vrms</td> <td>0.1Vrms</td> </tr> </tbody> </table>	类别 Type	Class 1	Class 2 / Low-DF	Class 3	频率 Frequency	1MHz(100KHz)	1kHz	1kHz	电压 Voltage	1.0Vrms	1.0Vrms	0.1Vrms
类别 Type	Class 1	Class 2 / Low-DF	Class 3														
频率 Frequency	1MHz(100KHz)	1kHz	1kHz														
电压 Voltage	1.0Vrms	1.0Vrms	0.1Vrms														
5	绝缘电阻 Insulation resistance (IR)	> 10 000MΩ	Class 2: > 6 000MΩ Low-DF: >10 000MΩ	≤25nF, >1 000MΩ >25nF, >25MΩμF	在室温下，两导线间施加额定电压(额定电压大于500V时使用500V)进行测量，时间不超过1分钟。 The insulation resistance should be measured with a DC voltage not exceeding the rated voltage (above 500V rated voltage tested by 500V) at room condition and less than 1 min. of charging.												
6	耐电压 Testing voltage (TV)	没有不合格 No failure.			在电容器两导线间施加表2测试电压1到5s后不被破坏(充/放电电流不大于50mA) The capacitor should not be damaged when test voltages of the table 2 are applied between the lead wires for 1 to 5 sec (Charge/Discharge current ≤50mA). 表2 Table 2												
					<table border="1"> <thead> <tr> <th>类别 Type</th> <th>Class 1 / Class 2 / Low-DF</th> <th>Class 3</th> </tr> </thead> <tbody> <tr> <td>额定电压(U_r) Rated Voltage (U_r)</td> <td>≤500V</td> <td>>500V</td> </tr> <tr> <td>测试电压 Testing Voltage</td> <td>2.5U_r</td> <td>1.5U_r+500V</td> </tr> <tr> <td></td> <td></td> <td>1.5U_r</td> </tr> </tbody> </table>	类别 Type	Class 1 / Class 2 / Low-DF	Class 3	额定电压(U _r) Rated Voltage (U _r)	≤500V	>500V	测试电压 Testing Voltage	2.5U _r	1.5U _r +500V			1.5U _r
类别 Type	Class 1 / Class 2 / Low-DF	Class 3															
额定电压(U _r) Rated Voltage (U _r)	≤500V	>500V															
测试电压 Testing Voltage	2.5U _r	1.5U _r +500V															
		1.5U _r															
7	温度特性 Temperature characteristic	无偏差 No bias	在误差范围内(见表A) Within the specified tolerance (see Table A).	在误差范围内(见表B) Within the specified tolerance (see Table B)	电容器必须按照表3中的步骤进行测量。 The capacitance measurement should be made at each step specified in the table 3. 表3 Table 3												
		容量漂移 Cap. drift	α>-150, ≤18pF, ±0.05pF >18pF, ±0.3% α≤-150 & SL: ±1.0%	<table border="1"> <thead> <tr> <th>步骤 Step</th> <th>1</th> <th>2</th> <th>3</th> <th>4</th> <th>5</th> </tr> </thead> <tbody> <tr> <td>温度 Temperature (±1°C)</td> <td>20°C</td> <td>-25°C (X7R: -55°C; Z5R: +10°C)</td> <td>20°C</td> <td>+85°C (X7R: +125°C)</td> <td>20°C</td> </tr> </tbody> </table> <p>*为2、3类瓷温度特性的前两码 *: The first two codes of the temperature characteristics of class 2, 3 ceramic dielectric</p>	步骤 Step	1	2	3	4	5	温度 Temperature (±1°C)	20°C	-25°C (X7R: -55°C; Z5R: +10°C)	20°C	+85°C (X7R: +125°C)	20°C
步骤 Step	1	2	3	4	5												
温度 Temperature (±1°C)	20°C	-25°C (X7R: -55°C; Z5R: +10°C)	20°C	+85°C (X7R: +125°C)	20°C												
8	导线抗张强度 Terminal tensile strength	引线不应断开，电容器不应破裂。 Lead wire should not be cut off capacitor should not be broken.			固定住电容器，在引线上逐步施加径向拉力直至10N，并保持10±1秒钟。 Fix the body of the capacitor and apply a tensile weight gradually to each lead wire in the radial direction of the capacitor up to 10N and keep it for 10±1 sec.												
9	导线抗折强度 Terminal bending strength	引线不应断开，电容器不应破裂。 Lead wire should not be cut off capacitor should not be broken.			在引线出口处沿一个方向施加5N、90°的弯曲压力，然后恢复至原始状态。之后，在2至3秒内再以相反方向施加一次90°的弯曲压力。 Each lead wire should be subjected to 5N of weight and bent 90° at the point of egress, in one direction, then returned to its original position and bent 90° in the opposite direction at the rate of one bent in 2 to 3 sec.												
10	可焊性 Solderability of leads	导线必须有3/4以上的面积均匀附着焊锡 Lead wire should be soldered with uniform coating on the axial direction over 3/4 of the circumferential direction.			电容器的导线必须浸入焊料中3±0.5秒钟，浸入深度离导线根部1.5-2.0mm。 The lead wire of a capacitor should be dipped into molten solder for 3±0.5 sec. The depth of immersion is up to about 1.5 to 2.0mm from the root of lead wires. 焊锡温度：无铅焊(Sn-3Ag-0.5Cu) 245±5°C Temp. of solder: Lead Free Solder (Sn-3Ag-0.5Cu) 245±5°C 易溶解的H63号锡235±5°C H63 Eutectic Solder 235±5°C												
11	APP	没有可见损伤 No marked defect			导线浸入离导线根部1.5-2.0mm处、锡温为260±10°C中3.5±0.5秒。 The lead wires should be immersed in solder of 260±5°C up to 1.5 to 2.0mm from the root of terminal for 3.5±0.5 sec. 预处理： Pre-treatment: 电容器必须先贮存在125±2°C条件下1小时，然后在室温下存放24±2小时，再进行初始测量。 Capacitor should be stored at 125±2°C for 1 hr., and then placed at room condition for 24±2 hrs. before initial measurements. 试验后处理： Post-treatment: 电容必须存放在室温下12小时(1类瓷：1~2小时)。 Capacitor should be stored for 12 hrs. (Class 1 type: 1~2 hrs.) at room condition.												
	ΔC/C	α≥-750: ≤100pF, ±0.5pF >100pF, ±0.5% α<-750 & SL: ≤100pF, ±1.0pF >100pF, ±1.0%	Y5P: ±10% X7R, Y5R: ±15% Y5U, Z5U: ±20% Y5V, Z5V: ±20%	Y5P: ±15% Y5U, Y5V: ±30%													
	IR	大于初始测量标准的50% More than 50% Initial specified value.															
	TV	如第6节进行试验，没有不合格 Per Item 6.															

圆板陶瓷电容器试验方法

TESTING METHODS FOR DISC CERAMIC CAPACITORS



— 德信立業 創新開拓 —

标准与试验方法

SPECIFICATIONS AND TESTING METHODS

■适用于WC1、WWC2、WC3和WCL
Suitable for WC1, WWC2, WC3 and WCL

序 No.	试验项目 Item	标准 Specifications			试验方法 Testing methods															
		Class 1	Class 2 / Low-DF	Class 3																
12	振动 Vibration resistance	APP	没有可见损伤 No marked defect		将电容器导线焊稳和调整振动频率范围为10-55Hz、总振幅为1.5mm，振动从10Hz到55Hz，然后再回到10Hz，大约一分钟。 The capacitor should be firmly soldered to the supporting lead wire and vibrated at a frequency range of 10 to 55Hz, 1.5mm in total amplitude, with about a 1 minute rate of vibration change from 10Hz to 55Hz and back to 10Hz. 总时间六个小时，每两小时在相互垂直方向来回三次。 Apply for a total of 6 hrs., 2 hrs. each in 3 mutually perpendicular directions.															
		C_r	如第3节进行试验，没有不合格 Per Item 3.																	
		$\tan\delta$ (Q)	如第4节进行试验，没有不合格 Per Item 4.																	
13	耐湿负荷 Humidity loading	APP	没有可见损伤 No marked defect		施加额定电压的电容器保持在温度为 $40\pm 2^\circ\text{C}$ 、相对湿度为90-95%条件下500 ± 12 小时。 Apply the rated voltage for 500 ± 12 hrs. at $40\pm 2^\circ\text{C}$ in 90 to 95% relative humidity. 试验后处理： Post-treatment: 电容器必须贮存在室温条件下12小时(1类瓷：1~2小时)。 Capacitor should be stored for 12 hrs. (Class 1 type: 1~2 hrs.) at room condition.															
		$\Delta C/C$	$\leq 33\text{pF}, \pm 1.0\text{pF}$ $> 33\text{pF}, \pm 3.0\%$	Y5P: $\pm 10\%$ X7R, Y5R: $\pm 15\%$ Y5U, Z5U: $\pm 20\%$ Y5V, Z5V: $\pm 20\%$		Y5P: $\pm 15\%$ Y5U, Y5V: $\pm 30\%$														
		$\tan\delta$ (Q)	大于初始标准的50% More than 50% initial specified value	小于2倍的初始标准值 Less than 200% Initial specified value.																
		IR	大于初始测量标准的25% More than 25% Initial specified value.																	
		TV	如第6节进行试验，没有不合格 Per Item 6.																	
14	高温负荷 High temperature load	APP	没有可见损伤 No marked defect		在 $85\pm 2^\circ\text{C}$ (X7R: $125\pm 2^\circ\text{C}$)、相对湿度不大于50%条件下施加1.5倍(3类瓷为1.2倍)额定电压1000+48/-0小时(充/放电电流小于50mA) Apply a DC voltage of 150% (Class 3 type: 120%) of the rated voltage for 1000+48/-0 hours at $85\pm 2^\circ\text{C}$ (X7R: $125\pm 2^\circ\text{C}$) with a relative humidity of 50% max. (Charge/discharge current $\leq 50\text{mA}$) 预处理 Pre-treatment: 电容器应储存在 125°C 条件下1小时，然后在室温下存放24小时，再进行初始测量。 Perform a heat treatment at 125°C for one hour and then set for 24 hours at room condition, perform the initial measurement. 试验后处理 Post-treatment: 电容器必须贮存在室温条件下24小时。 Capacitor should be stored for 24 hrs. at room condition.															
		$\Delta C/C$	$\leq 20\text{pF}, \pm 1.0\text{pF}$ $> 20\text{pF}, \pm 5.0\%$	Y5P: $\pm 10\%$ X7R, Y5R: $\pm 15\%$ Y5U, Z5U: $\pm 20\%$ Y5V, Z5V: $\pm 30\%$		Y5P: $\pm 15\%$ Y5U, Y5V: $\pm 30\%$														
		$\tan\delta$ (Q)	大于初始标准的50% More than 50% initial specified value	小于2倍的初始标准值 Less than 200% Initial specified value.																
		IR	大于初始测量标准的25% More than 25% Initial specified value.																	
		TV	如第6节进行试验，没有不合格 Per Item 6.																	
15	温度循环 Temperature and immersion cycle	APP	没有可见损伤 No marked defect		电容器应表4规定的步骤与条件承受五次温度循环。 The capacitor should be subjected to 5 temperature cycles according to the step and conditions in the table 4. 表4 Table 4 <table border="1" style="display: inline-table; vertical-align: middle;"> <thead> <tr> <th>步骤 Step</th> <th>1</th> <th>2</th> <th>3</th> <th>4</th> </tr> </thead> <tbody> <tr> <td>温度 Temperature</td> <td>5~35$^\circ\text{C}$</td> <td>-25$\pm 2^\circ\text{C}$ (X7R: -55$\pm 2^\circ\text{C}$)</td> <td>5~35$^\circ\text{C}$</td> <td>85$\pm 2^\circ\text{C}$ (X7R: 125$\pm 2^\circ\text{C}$)</td> </tr> <tr> <td>时间 Time</td> <td>5± 2min</td> <td>30± 2min</td> <td>5± 2min</td> <td>30± 2min</td> </tr> </tbody> </table> 预处理 Pre-treatment: 电容器必须先贮存在 125°C 条件下1小时，然后在室温下存放24小时，再进行初始测量。 Perform a heat treatment at 125°C for one hour and then set for 24 hours at room condition, perform the initial measurement. 试验后处理 Post-treatment: 电容器必须贮存在室温条件下24小时。 Capacitor should be stored for 24 hrs. at room condition.	步骤 Step	1	2	3	4	温度 Temperature	5~35 $^\circ\text{C}$	-25 $\pm 2^\circ\text{C}$ (X7R: -55 $\pm 2^\circ\text{C}$)	5~35 $^\circ\text{C}$	85 $\pm 2^\circ\text{C}$ (X7R: 125 $\pm 2^\circ\text{C}$)	时间 Time	5 ± 2 min	30 ± 2 min	5 ± 2 min	30 ± 2 min
		步骤 Step	1	2		3	4													
		温度 Temperature	5~35 $^\circ\text{C}$	-25 $\pm 2^\circ\text{C}$ (X7R: -55 $\pm 2^\circ\text{C}$)		5~35 $^\circ\text{C}$	85 $\pm 2^\circ\text{C}$ (X7R: 125 $\pm 2^\circ\text{C}$)													
		时间 Time	5 ± 2 min	30 ± 2 min		5 ± 2 min	30 ± 2 min													
		$\Delta C/C$	$\alpha \geq -750$: $\leq 100\text{pF}, \pm 0.5\text{pF}$ $> 100\text{pF}, \pm 0.5\%$ $\alpha < -750$ & SL: $\leq 100\text{pF}, \pm 1.0\text{pF}$ $> 100\text{pF}, \pm 1.0\%$	Y5P: $\pm 10\%$ X7R, Y5R: $\pm 15\%$ Y5U, Z5U: $\pm 20\%$ Y5V, Z5V: $\pm 20\%$		Y5P: $\pm 15\%$ Y5U, Y5V: $\pm 30\%$														
$\tan\delta$ (Q)	大于初始标准的50% More than 50% initial specified value	小于2倍的初始标准值 Less than 200% Initial specified value.																		
IR	大于初始测量标准的50% More than 50% Initial specified value.																			
TV	如第6节进行试验，没有不合格 Per Item 6.																			

■表A—1类瓷产品容量变化率表
Table A — Capacitance change of Class 1 type products

温度系数 Temperature coefficient (α)	标称值 Nominal value (10 3 K)	相对20 $^\circ\text{C}$ 时的容量变化率 Capacitance change from 20 $^\circ\text{C}$ (%)			
		-55 $^\circ\text{C}$	-25 $^\circ\text{C}$	+85 $^\circ\text{C}$	+125 $^\circ\text{C}$
NPO	0 ± 60	-0.45~-0.819	-0.27~-0.491	-0.39~-0.39	-0.63~-0.63
N80	-75 ± 30	0.338~-1.23	0.203~-0.738	-0.683~-0.293	-1.10~-0.473
N150	-150 ± 60	0.675~-2.19	0.405~-1.31	-1.37~-0.585	-2.21~-0.945
N220	-220 ± 60	1.20~-2.83	1.70~-0.72	-1.82~-1.04	-2.94~-1.68
N330	-330 ± 60	2.03~-3.84	1.22~-2.30	-2.54~-1.76	-4.10~-2.84
N470	-470 ± 60	3.08~-5.12	1.85~-3.07	-3.45~-2.67	-5.57~-4.31
N750	-750 ± 120	4.73~-8.23	2.84~-4.94	-5.66~-4.10	-9.14~-6.62

■表B—2、3类瓷及低损耗类产品容量变化率表
Table B — Capacitance change of Class 2, Class 3 and Low-DF type products

温度特性 Temperature characteristic (TC)	下限类别温度 Lower category temperature (LCT)	上限类别温度 Upper category temperature (UCT)	容量变化率 Capacitance change ($\Delta C/C$)
Y5P	-25 $^\circ\text{C}$	+85 $^\circ\text{C}$	$\pm 10\%$
Y5R			$\pm 15\%$
Y5U			+22%/ -56%
Y5V	+10 $^\circ\text{C}$	+85 $^\circ\text{C}$	+22%/ -82%
Z5U			+22%/ -56%
Z5V			+22%/ -82%
X7R	-55 $^\circ\text{C}$	+125 $^\circ\text{C}$	$\pm 15\%$

包装 PACKAGING

■ 散件包装 Bulk packing

散件包装最小包装为PE袋，其包装数量如下表所示；一定数量的最小包装装入内盒中，最后4个小盒或10个小盒，装入大箱中，具体由产品规格确定。

The minimum packing of bulk packaging is PE bag, the packing quantity is shown in the following table; a certain number of minimum packaging into the inner box, the last 4 inner boxes or 10 inner boxes, loaded into the outer box, specifically determined by the product specifications.

额定电压 Rated voltage	脚长 Lead length	产品直径 Body diameter	最小包装数量 Minimum packaging quantity
<4kVdc	≤16mm	All	1 000
	>16mm	≤8.5mm	1 000
		>8.5mm	500
4kVdc (Y2)	≤16mm	All	500
	>16mm	≤8.5mm	1 000
		>8.5mm	500
>4kVdc (Y1)	≤16mm	All	500
	>16mm	≤8.5mm	1 000
		>8.5mm	500

■ 编带包装 Taping packing

编带尺寸规格见下一页，其包装盒或卷盘尺寸，及最小包装数量如下表所示

The taping specifications are shown on the next page, the dimensions of the ammo or reel, and minimum packaging quantity are shown in the following table

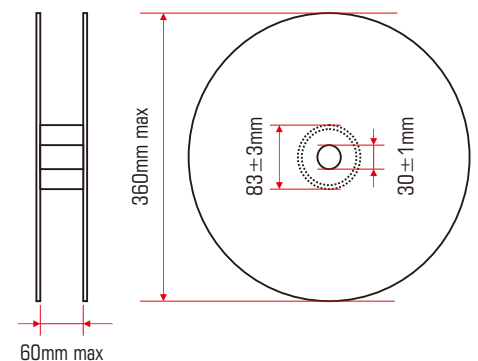
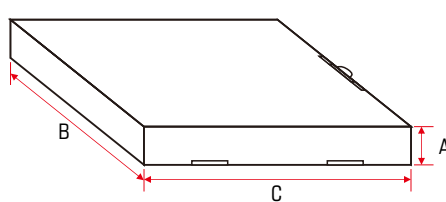
包装方式 Packaging format	卷盘包装 Reel packaging	折叠包装 Ammo packaging						
尺寸(mm)与图示 Dimensions (mm) and drawing		 <table border="1" data-bbox="989 1680 1404 1769"> <thead> <tr> <th>A</th> <th>B</th> <th>C</th> </tr> </thead> <tbody> <tr> <td>43±2mm</td> <td>256±5mm</td> <td>335±5mm</td> </tr> </tbody> </table>	A	B	C	43±2mm	256±5mm	335±5mm
A	B	C						
43±2mm	256±5mm	335±5mm						
包装数量(pcs) Quantity (pcs)	500~2 500 per reel	500~2000 per ammo						

卷盘包装一盘装四盒，每盒二盘；折叠包装一盒装十盒。

Reel packaging 4 boxes per carton, 2 reels per boxed; Ammo packaging 10 boxes per carton.

编带规格 TAPING SPECIFICATIONS

方式1 Method 1

如下图所示：
As shown in the following figure:

孔距(P0)与元件间距离(P)均为12.7mm
或者，孔距(P0)与元件间距离(P)均为15.0mm
12.7mm by feed hole pitch (P0) and components pitch (P)
or, 15.0mm by feed hole pitch (P0) and components pitch (P)

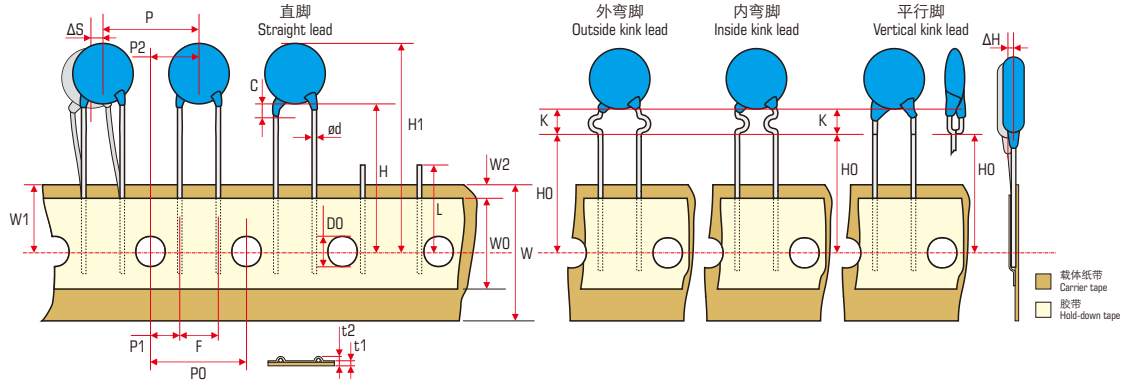

方式2 Method 2

如下图所示：
As shown in the following figure:

孔距(P0)为12.7mm，元件间距离(P)为24.4mm
Feed hole pitch (P0) with 12.7mm and components pitch (P) with 25.4mm

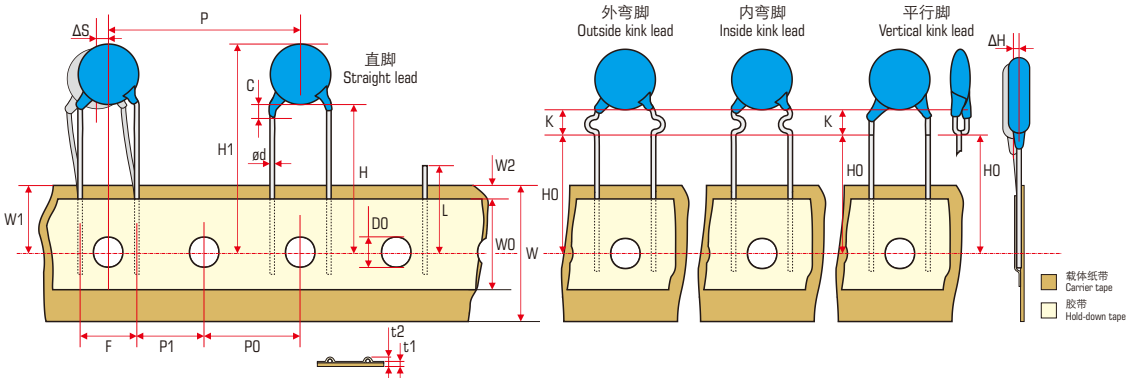

尺寸规格(mm) Dimensions (mm)

项目 Item	代码 Symbol	方式一 Method 1	方式二 Method 2	公差 Tolerance	进料孔与元件间距离 Hole center to component center P2	进料孔与元件间距离 Feed hole center to lead P1	元件间距 Component pitch P	元件间距 Feed hole pitch P0	脚宽 Lead-to-lead distance F	元件直径 Lead wire diameter ad	元件沿编带偏差，前或后 Deviation along tape, front or back Δh	元件沿编带偏差，左或右 Deviation along tape, left or right Δs	纸带宽 Tape width W	胶带宽 Hold-down tape width W0	孔位 Hole position W1	胶带位置 Hole - down tape position W2	元件到纸带中心的高度 Height of component from tape center		元件高度 Component height H1	进料孔直径 Feed hole diameter D0	总带厚度 Total tape thickness t1	带厚度 Lead thickness t2	剪刃长度 Snipped length L	涂胶层长度 Coating rundown on leads C	封装高度 Height of kink K
																	直脚类型 Straight lead type H	弯脚类型 Kinked lead type H0							
标准		5.0	7.5	±0.8	6.35	3.85	12.7	12.7	5.0	0.55	1.3	2.0	18.0	7.0	9.0	3.0	18.0	16.0	40.0*	4.0	0.9	1.5	11.0	3.0**	5.0
公差		7.5	10.0	±1.0	7.5	8.95	15.0	15.0	7.5	±0.1	max	max	+1.0 -0.5	min	+0.75 -0.5	max	+2.0 -0	±0.5	max	±0.3	max	max	max	max	max

*: 根据产品直径大小会而变化。
It varies according to the diameter of the product.
**: 酚醛封装产品其最大值为1.5mm，CC、CY等环氧封装产品其最大值为2.0mm。
Phenolic coating product are 1.5mm max., epoxy coating product of CC, CY type are 2.0mm max.