

RoHS

CAD GENERATED DRAWING. DON'T CHANGE BY HAND.

REV.	ECN. NO.	APPD.

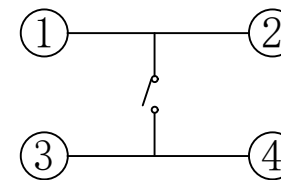
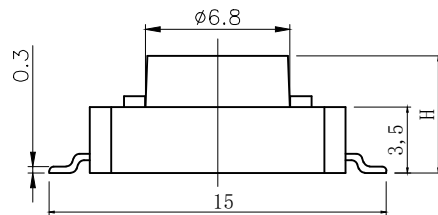
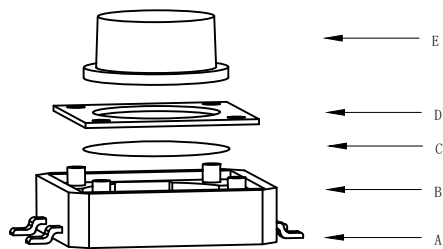

CIRCUIT DIAGRAM

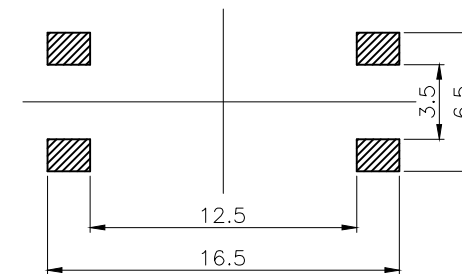
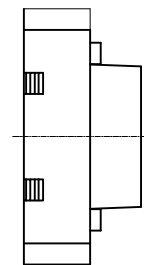
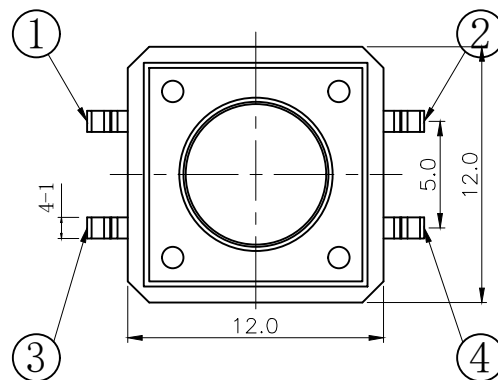
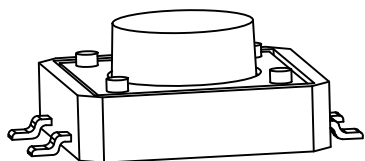

PCB. WELDING DRAWING

Specification

Operating Life	100,000
Contact rating	50mA@12V DC.
Insulation resistance	1011Ω min.
Contact resistance	100mΩ max. initial.
Dielectric Strength	250 V AC(1mm)
Travel	0.3±0.1mm
Storage Temperature	-30° C to 85° C

Packaging:
A reel of 500 pieces

Mechanical

ITEM	DESCRIPTION	MATERIAL	QTY	FINISH/COLOR
E	Button	PPA	1	Black
D	COVER	Brass	1	Cleaning
C	DOME	Stainless Steel	1	Plated Ag
B	HOUSING	PPA	1	Black
A	PIN	PHOSPHOR BRONZE	1	Plated Ag

Type	Operatin Force (gf)	Heiht mm	Button	Leads Shape (G, J, T)	Ground pin (G, L)	Pegs Option (G, L)
YTS1B002	250±50	Q	15.0	B (BLACK)	G	0 (None)
		P	13.0			
		O	12.0			
		N	11.0			
		M	10.0			
		L	9.0			
		K	8.5			
		J	8.0			
		H	7.5			
		G	7.0			
		F	6.5			
		E	6.0			
		D	5.5			
C	5.0					
B	4.5					
A	4.3					

THESE DRAWINGS AND SPECIFICATIONS ARE THE PROPERTY OF YIYUAN TECHNOLOGY CO.,LTD AND SHALL NOT BE REPRODUCED, COPIED OR USED IN ANY MANNER WITHOUT THE PRIOR WRITTEN CONSENT OF YIYUAN TECHNOLOGY CO.,LTD

.X ±0.50	.X° ±2°	UNITS mm
.XX ±0.30	.XX° ±1°	
.XX ±0.10	.XX° ±0.5°	MAT'L
.XXX ±0.05		FINISH
		Q'TY

深圳市怡远科技有限公司
SHENZHEN YIYUAN TECHNOLOGY CO., LTD

PART NO.
YTS1B002

APPD: ROGER

CHKD: ROC

DR: BILLY WANG 2020/08/21

TITLE:
TACTILE SWITCH

DWG NO. :
YTS1B002

SCALE	SHEET	REV.
1/1	1/1	A1