

| REV. | ECN NO. | APPD. |
|------|---------|-------|
| A    |         |       |

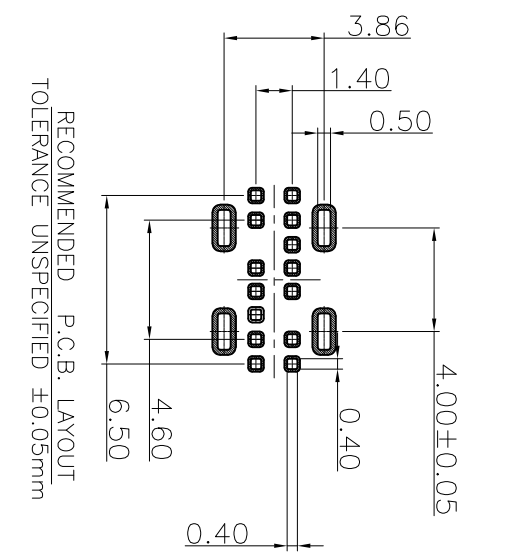
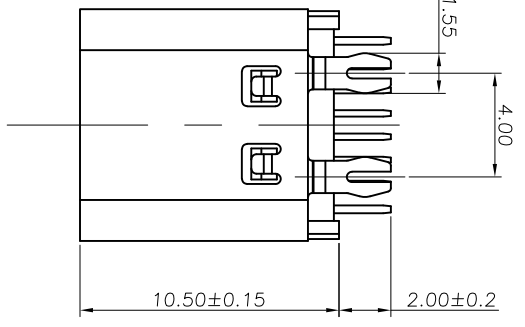

RECOMMENDED P.C.B. LAYOUT  
TOLERANCE UNSPECIFIED ±0.05mm

- 备注:
1. 材质及电镀: 见附表1
  2. 电气性能:
    - 2.1 接触电阻: 30mΩ Max FOR INITIAL. 40mΩ Max AFTER TEST.
    - 2.2 耐电压: 100V AC
    - 2.3 绝缘: 100MΩ Min
    - 2.4 额定电流:
  3. 机械性能:
    - 3.1 插入力: 5~20N.
    - 3.2 拔出力: 初始值8~20N测试后6~20N
    - 3.3 寿命: 10,000 CYCLES
  4. 工作温度: -40° C ~ 80° C.

COLLECTIVELY VBUS PIN (A4,A9,B4,B9) ,TOTAL 5A  
VCCON PIN (B5) THROUGH GND PIN(A1,A12,B1,B12),1.25A

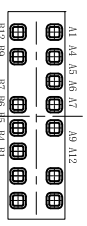
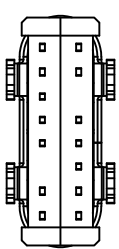
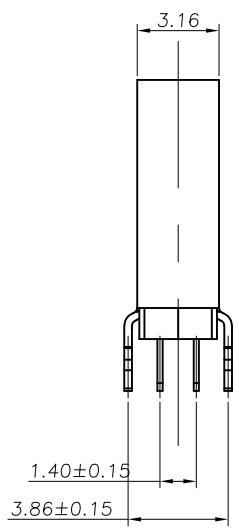
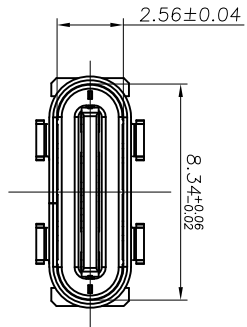

|     |             |     |             |
|-----|-------------|-----|-------------|
| A1  | GND         | B12 | GND         |
| A4  | VBUS        | B9  | VBUS        |
| A5  | CCI         | B7  | DN2         |
| A6  | DP1         | B6  | DP2         |
| A7  | DMT         | B5  | CC2         |
| A9  | VBUS        | B4  | VBUS        |
| A12 | GND         | B1  | GND         |
| PIN | SIGNAL NAME | PIN | SIGNAL NAME |

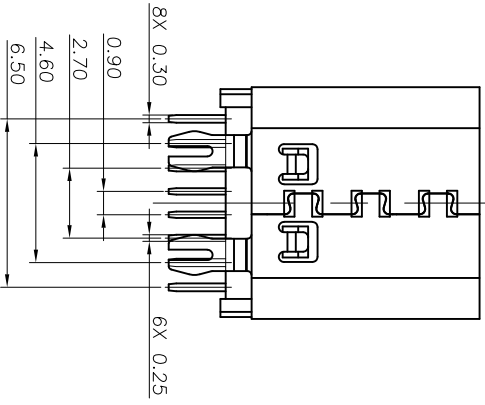

|    |            |                 |      |                    |    |
|----|------------|-----------------|------|--------------------|----|
| 05 | 外壳         | 不锈钢             | 1    | SUS 304 1/2H,10.30 |    |
| 04 | 二次Molding件 | LCP             | 1    | 黑色 U194 V-0        |    |
| 03 | 一次Molding件 | LCP             | 1    | 黑色 U194 V-0        |    |
| 02 | 中夹片        | SUS301-H T=0.15 | 1    | 不电镀                |    |
| 01 | 端子         | C18400-H T=0.20 | 1set | 功能接触区镀金, 焊脚镀镍      | 备注 |
|    | 序号 品名      | 材质              | 用量   |                    |    |

|      |       |        |       |        |    |
|------|-------|--------|-------|--------|----|
| X.   | ±0.30 | X.°    | ±5°   | UNITS  | mm |
| .X   | ±0.20 | .X.°   | ±2°   | MAT'L  |    |
| .XX  | ±0.10 | .XX.°  | ±1°   |        |    |
| .XXX | ±0.05 | .XXX.° | ±0.5° | FINISH |    |

|                  |     |
|------------------|-----|
| TYPE C CONNECTOR | QTY |
|------------------|-----|

|                     |                         |                          |
|---------------------|-------------------------|--------------------------|
| NAME/(INTENDED USE) | PART NO. (INTENDED USE) | TITLE:                   |
|                     |                         | TYPE C 14P母座180度插板H=10.5 |
| APPD: SUNNY         | CHKD: USA               | DWG NO.: 26003-UCAF002-X |
| DR: ZOE             | 2022-06-10              | SCALE 1/1                |
|                     |                         | SHEET 1/1                |
|                     |                         | REV. A                   |

**MINTRON CO.,LTD.**