

REV.	ECH. NO.	APPD.
A		

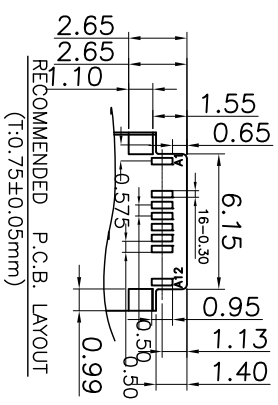
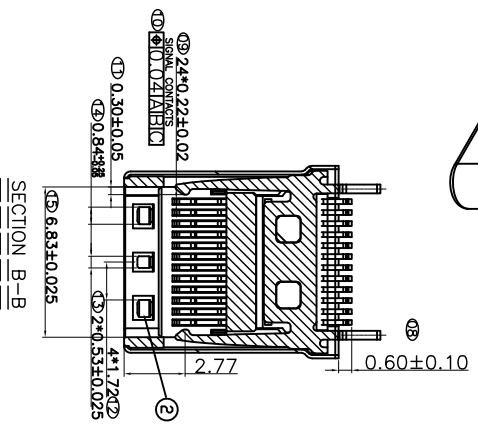
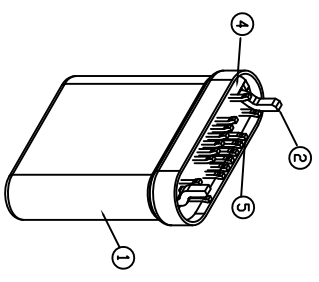
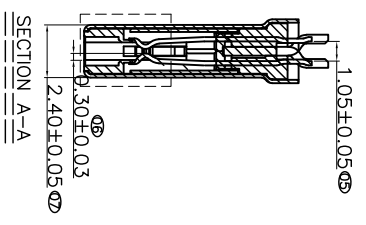
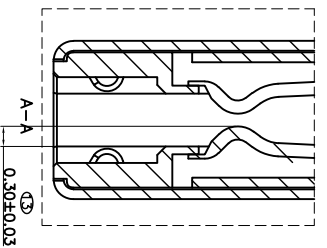
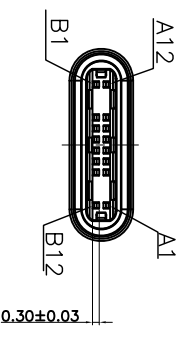
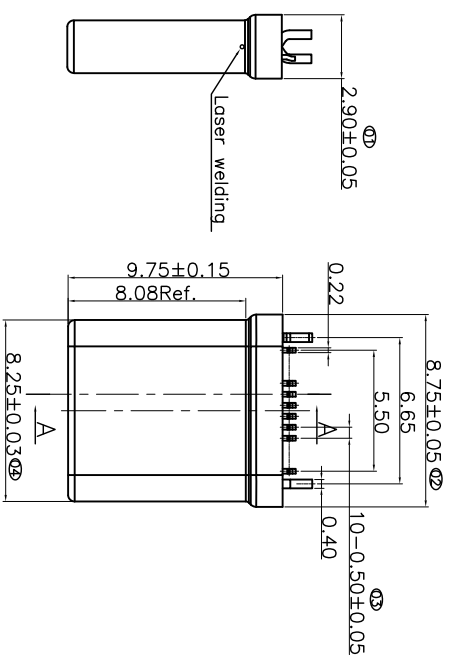
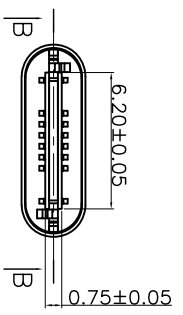

NO.	DESCRIPTION	MATERIAL	COLOR	REMARK
1	Shell	STAINLESS STEEL	—	Ni Plated
2	Terminal	COPPER ALLOY	—	Gold Plated
3	Latch	STAINLESS STEEL	—	SN Plated
4	Molding	HIGH TEMP	BLACK	UL 94V-0
5	Housing	HIGH TEMP	WHITE	UL 94V-0

X.	±0.30	X°	±5°	UNITS	mm
X	±0.20	X°	±2°	MATL	
XX	±0.10	XX°	±1°		
XXX	±0.05	XXX°	±0.5°	FINISH	

NAME (INTENDED USE)		PART NO. (INTENDED USE)		TITLE:	
TYPE C CONNECTOR		24007-UCAM001-B		TYPE C公头16P不带板 (华为款) 无孔	
APPD:	SUNNY	DWG NO.:	24007-UCAM001-B		
CHKD:	USA	SCALE	1/1	SHEET	1/1
DR:	ZOE	2022-06-10		REV.	A

**MINTRON CO., LTD.**