

SOT-23-6L Plastic-Encapsulate Transistors

CJ2045 Dual 40V complementary transistors

FEATURES

- 40V complementary device
- High h_{FE}
- Mounting cost and area can be cut in half

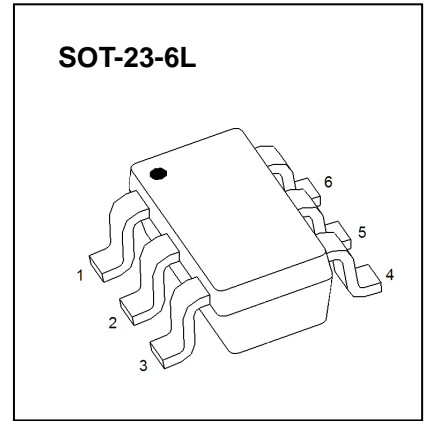

MARKING

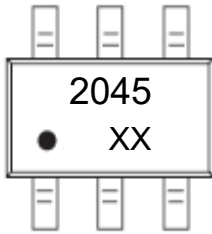

2045=Device code
Solid point=Pin1 positioning point
XX=Date Code

PIN1

EQUIVALENT CIRCUIT

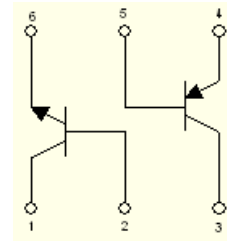

Tr1 NPN and Tr2 PNP Absolute Maximum Ratings ($T_a=25^\circ\text{C}$)

Symbol	Parameter	Value		Unit
		NPN	PNP	
V_{CBO}	Collector-Base Voltage	40	-40	V
V_{CEX}	Collector-Emitter Voltage	40	-40	V
V_{CEO}	Collector-Emitter Voltage	30	-30	V
V_{EBO}	Emitter-Base Voltage	7	-7	V
I_C	Collector Current- Continuous	1.5	-1.5	A
I_{CM}	Collector Current- Peak	5	-5	A
P_C	Collector Power Dissipation	350	350	mW
$R_{\theta JA}$	Thermal Resistance from Junction to Ambient	357	357	$^\circ\text{C}/\text{W}$
T_J, T_{stg}	Operation Junction and Storage Temperature Range	-55~+150		$^\circ\text{C}$

ELECTRICAL CHARACTERISTICS

Tr1 NPN ($T_a=25^\circ\text{C}$ unless otherwise specified)

Parameter	Symbol	Test conditions	Min	Typ	Max	Unit
Collector-base breakdown voltage	$V_{(BR)CBO}$	$I_C=100\mu\text{A}$, $I_E=0$	40			V
Collector-emitter breakdown voltage	$V_{(BR)CEO}^*$	$I_C=10\text{mA}$, $I_B=0$	30			V
Collector-emitter breakdown voltage	$V_{(BR)CEX}$	$I_C=1\mu\text{A}$, $V_{BE(off)}=-0.5\text{V}$	40			V
Emitter-base breakdown voltage	$V_{(BR)EBO}$	$I_E=100\mu\text{A}$, $I_C=0$	7			V
Collector cut-off current	I_{CBO}	$V_{CB}=32\text{V}$, $I_E=0$			20	nA
Collector cut-off current	I_{CER}	$V_{CE}=16\text{V}$, $R\leq 1\text{k}\Omega$			20	nA
Emitter cut-off current	I_{EBO}	$V_{EB}=6\text{V}$, $I_C=0$			20	nA
DC current gain	h_{FE}^*	$V_{CE}=2\text{V}$, $I_C=100\text{mA}$	180		500	
Collector-emitter saturation voltage	$V_{CE(sat)}^*$	$I_C=750\text{mA}$, $I_B=15\text{mA}$			0.375	V
Base-emitter saturation voltage	$V_{BE(sat)}^*$				1.2	V

Tr2 PNP ($T_a=25^\circ\text{C}$ unless otherwise specified)

Parameter	Symbol	Test conditions	Min	Typ	Max	Unit
Collector-base breakdown voltage	$V_{(BR)CBO}$	$I_C=-100\mu\text{A}$, $I_E=0$	-40			V
Collector-emitter breakdown voltage	$V_{(BR)CEO}^*$	$I_C=-10\text{mA}$, $I_B=0$	-30			V
Collector-emitter breakdown voltage	$V_{(BR)CEX}$	$I_C=-1\mu\text{A}$, $V_{BE(off)}=0.5\text{V}$	-40			V
Emitter-base breakdown voltage	$V_{(BR)EBO}$	$I_E=-100\mu\text{A}$, $I_C=0$	-7			V
Collector cut-off current	I_{CBO}	$V_{CB}=-32\text{V}$, $I_E=0$			-20	nA
Collector cut-off current	I_{CER}	$V_{CE}=-16\text{V}$, $R\leq 1\text{k}\Omega$			-20	nA
Emitter cut-off current	I_{EBO}	$V_{EB}=-6\text{V}$, $I_C=0$			-20	nA
DC current gain	h_{FE}^*	$V_{CE}=-2\text{V}$, $I_C=-100\text{mA}$	180		500	
Collector-emitter saturation voltage	$V_{CE(sat)}^*$	$I_C=-750\text{mA}$, $I_B=-15\text{mA}$			-0.375	V
Base-emitter saturation voltage	$V_{BE(sat)}^*$				-1.2	V

*Pulse Test : Pulse Width $\leq 300\mu\text{s}$, Duty Cycle $\leq 2\%$.

Typical Characteristics

NPN Transistor

Static Characteristic

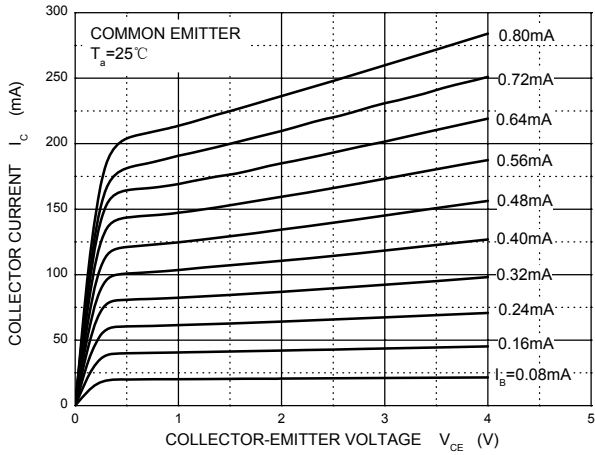

h_{FE} — I_C

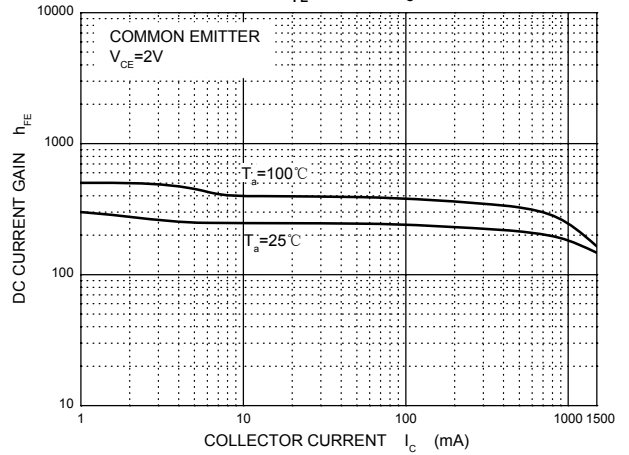

V_{BEsat} — I_C

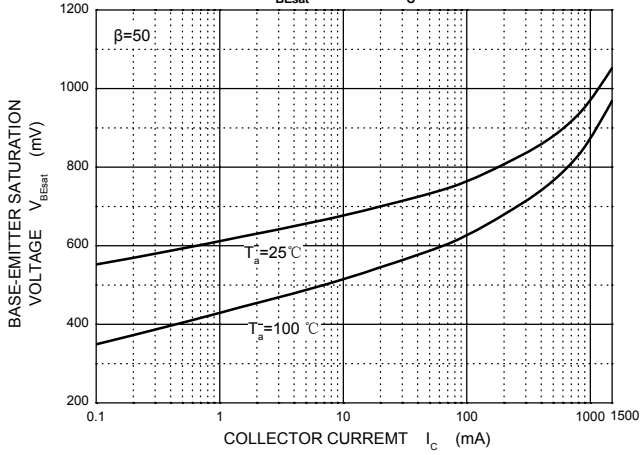

V_{CEsat} — I_C

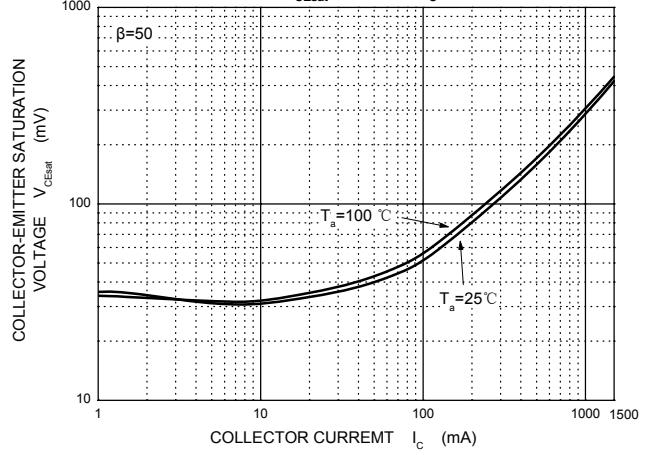

I_C — V_{BE}

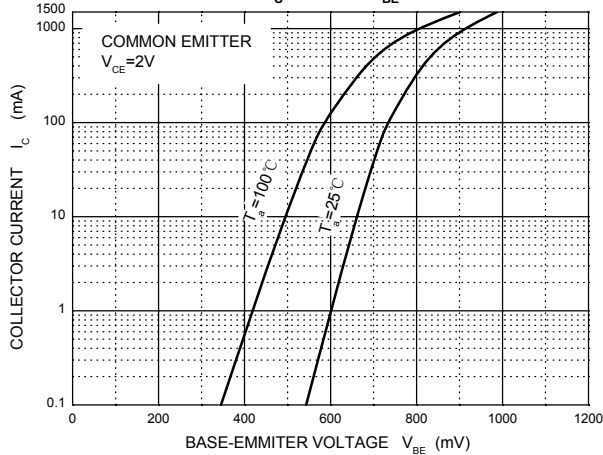

f_T — I_C

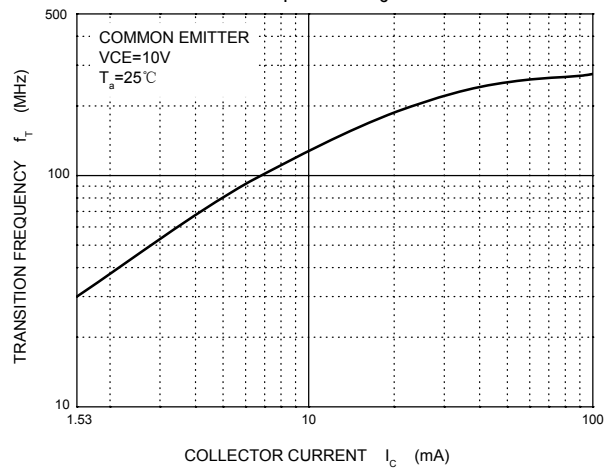

C_{ob}/C_{ib} — V_{CB}/V_{EB}

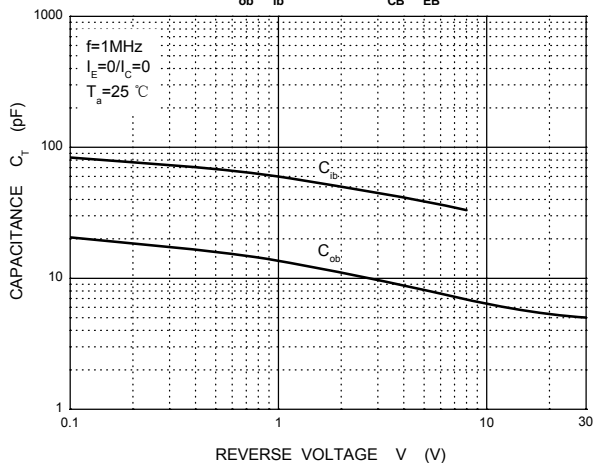

P_C — T_a

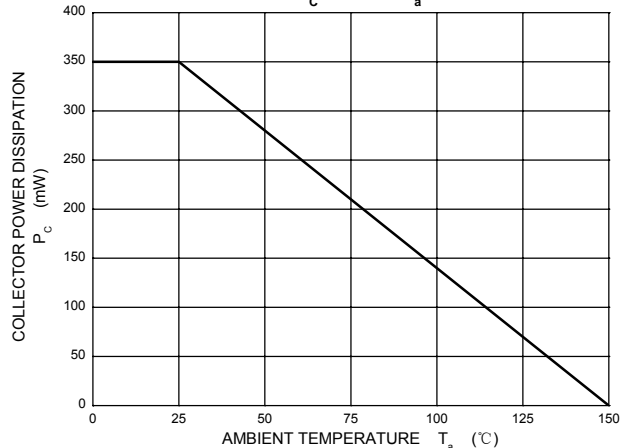

Typical Characteristics

PNP Transistor

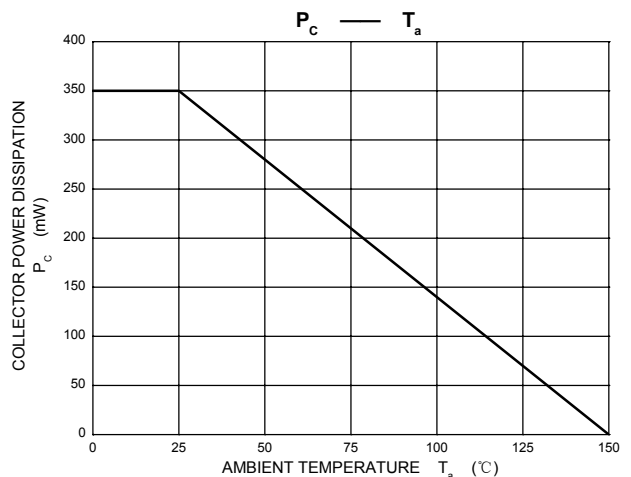
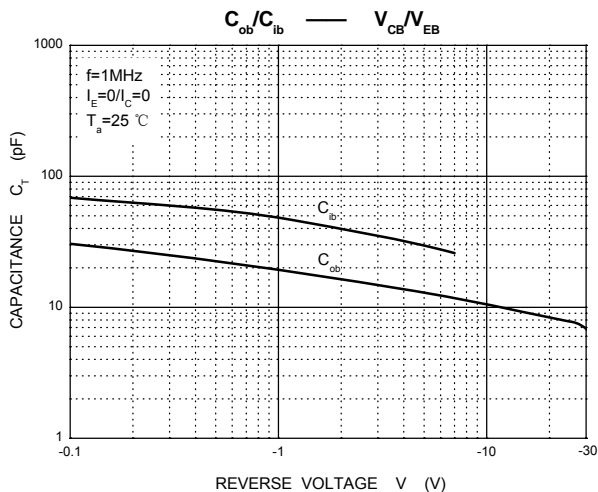
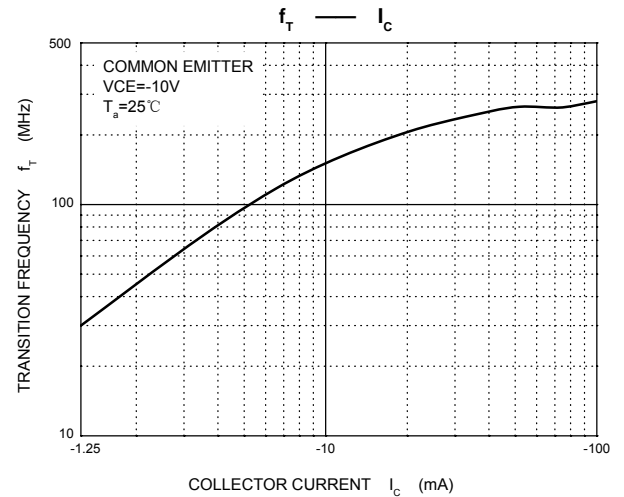
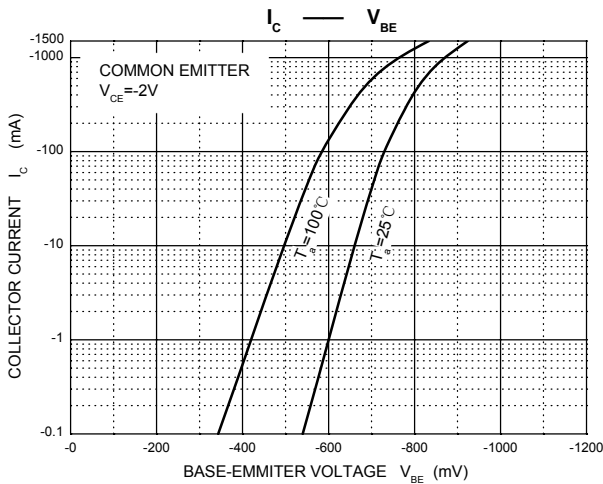
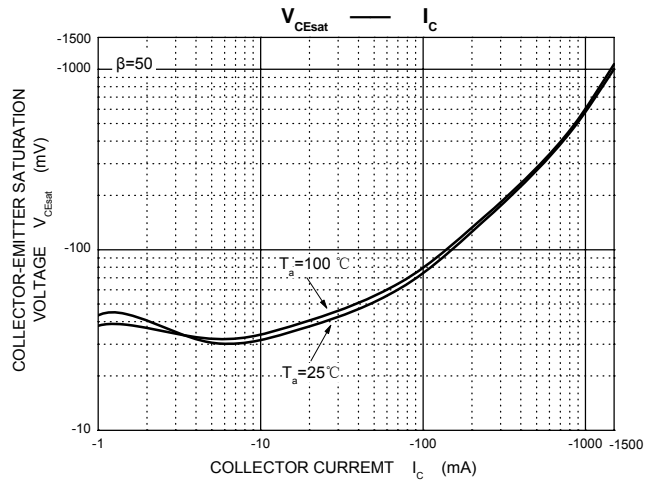
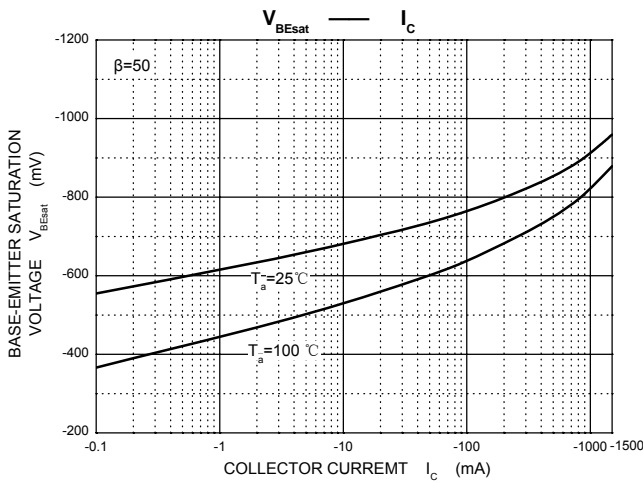
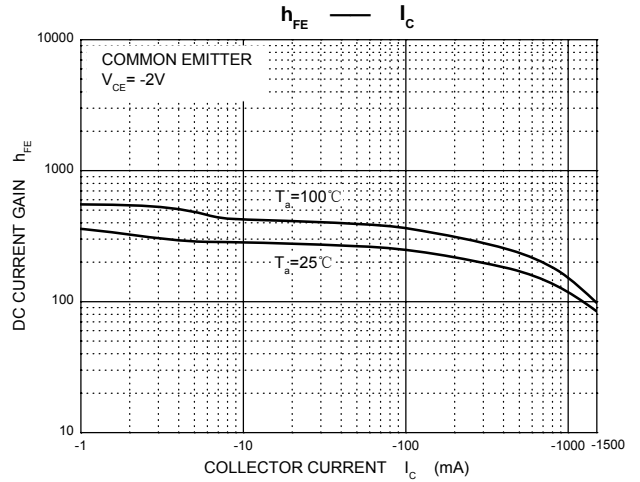
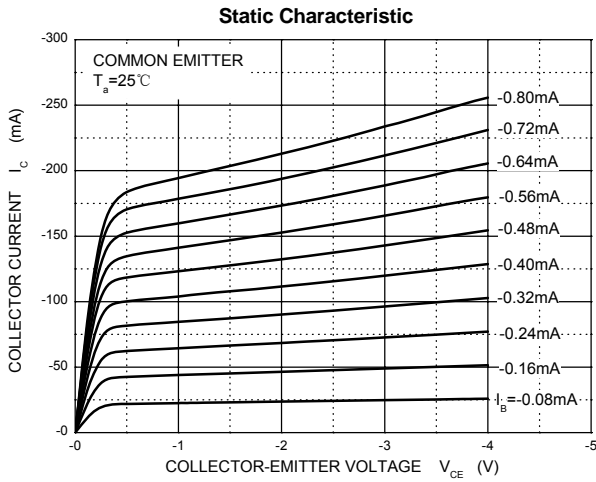

SOT-23-6L Package Outline Dimensions

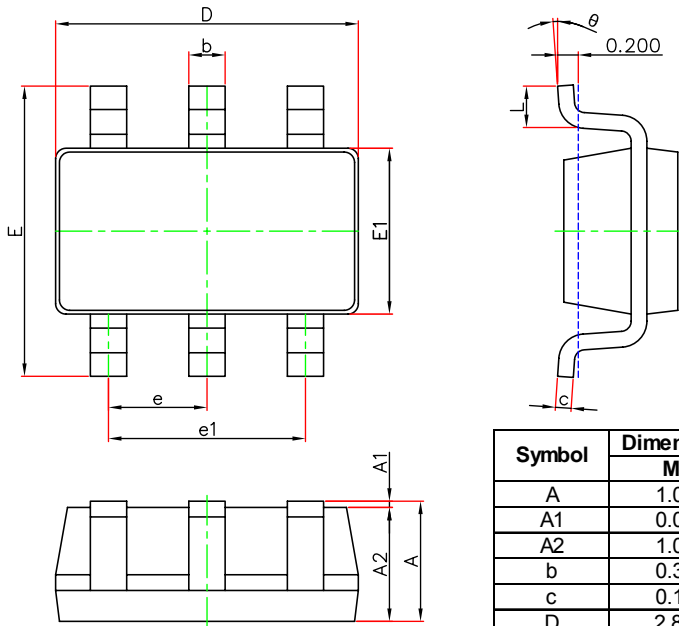

Symbol	Dimensions In Millimeters		Dimensions In Inches	
	Min.	Max.	Min.	Max.
A	1.050	1.250	0.041	0.049
A1	0.000	0.100	0.000	0.004
A2	1.050	1.150	0.041	0.045
b	0.300	0.500	0.012	0.020
c	0.100	0.200	0.004	0.008
D	2.820	3.020	0.111	0.119
E1	1.500	1.700	0.059	0.067
E	2.650	2.950	0.104	0.116
e	0.950(BSC)		0.037(BSC)	
e1	1.800	2.000	0.071	0.079
L	0.300	0.600	0.012	0.024
θ	0°	8°	0°	8°

SOT-23-6L Suggested Pad Layout

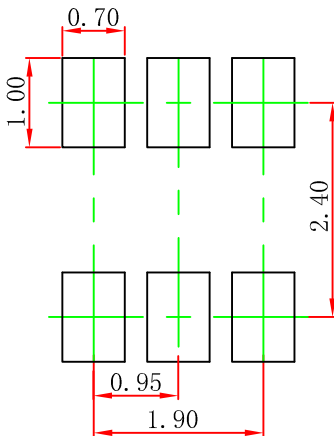

Note:

1. Controlling dimension: in millimeters.
2. General tolerance: ± 0.05 mm.
3. The pad layout is for reference purposes only.

NOTICE

JSCJ reserves the right to make modifications, enhancements, improvements, corrections or other changes without further notice to any product herein. JSCJ does not assume any liability arising out of the application or use of any product described herein.

SOT-23-6L Tape and Reel

SOT-23-6L Embossed Carrier Tape

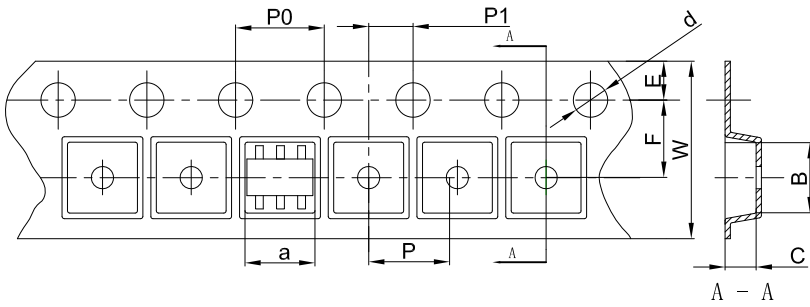

Packaging Description:

SOT-23-6L parts are shipped in tape. The carrier tape is made from a dissipative (carbon filled) polycarbonate resin. The cover tape is a multilayer film (Heat Activated Adhesive in nature) primarily composed of polyester film, adhesive layer, sealant, and anti-static sprayed agent. These reeled parts in standard option are shipped with 3,000 units per 7" or 18.0cm diameter reel. The reels are clear in color and is made of polystyrene plastic (anti-static coated).

Dimensions are in millimeter										
Pkg type	a	B	C	d	E	F	P0	P	P1	W
SOT-23-6L	3.17	3.23	1.37	Ø1.55	1.75	3.50	4.00	4.00	2.00	8.00

SOT-23-6L Tape Leader and Trailer

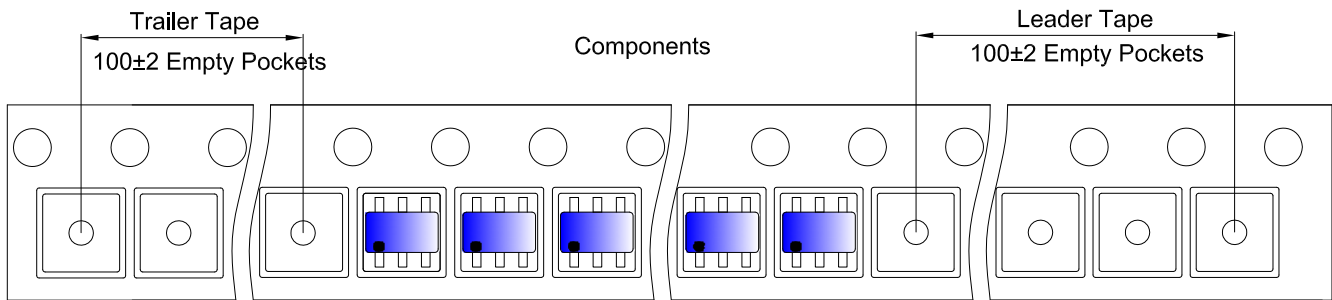

SOT-23-6L Reel

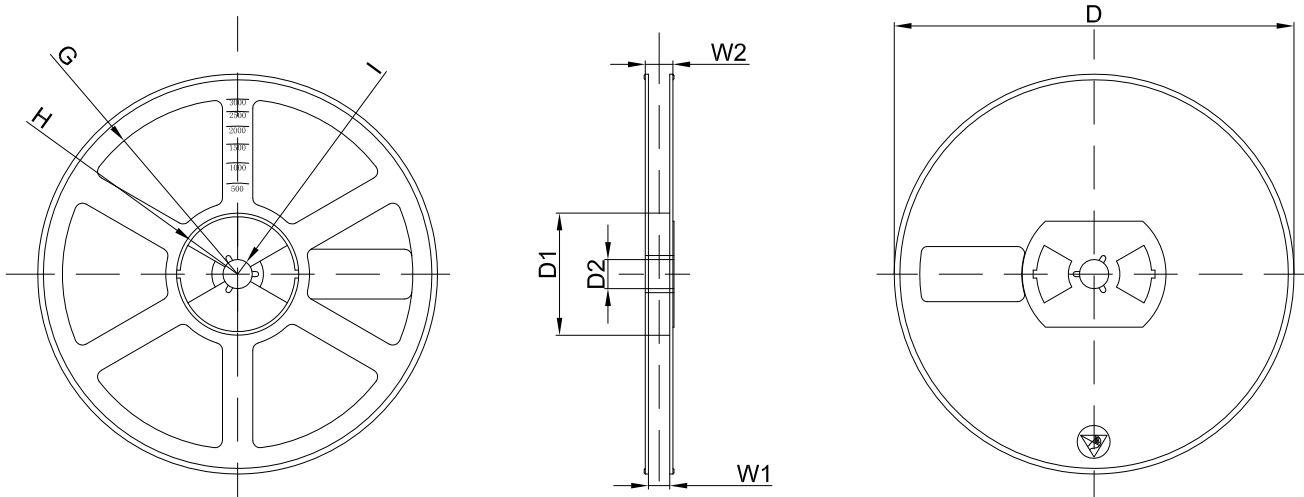

Dimensions are in millimeter								
Reel Option	D	D1	D2	G	H	I	W1	W2
7" Dia	Ø180.00	60.00	13.00	R78.00	R25.60	R6.50	9.50	13.10

REEL	Reel Size	Box	Box Size(mm)	Carton	Carton Size(mm)	G.W.(kg)
3000 pcs	7 inch	30,000 pcs	203×203×195	120,000 pcs	438×438×220	