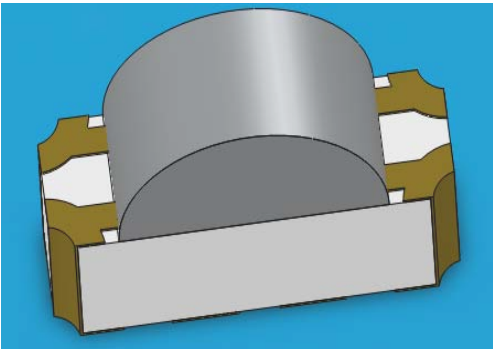

SMD ■ B

12-23A/Y2G6BHC-A30/2D

**Features**

- Package in 8mm tape on 7" diameter reel.
- Compatible with automatic placement equipment.
- Compatible with infrared and vapor phase reflow solder process.
- Full-color type.
- Pb-free.
- The product itself will remain within RoHS compliant version.
- Compliance with EU REACH
- Compliance Halogen Free .(Br <900 ppm ,Cl <900 ppm , Br+Cl < 1500 ppm).

Description

- The 12-23A SMD LED is much smaller than lead frame type components, thus enable smaller board size, higher packing density, reduced storage space and finally smaller equipment to be obtained.
- Besides, lightweight makes them ideal for miniature applications. etc.

Applications

- Backlighting in dashboard and switch.
- Telecommunication: indicator and backlighting in telephone and fax.
- Flat backlight for LCD, switch and symbol.
- General use.

Device Selection Guide

Code	Chip Materials	Emitted Color	Resin Color
Y2	AlGaInP	Brilliant Yellow	
G6	AlGaInP	Brilliant Yellow Green	Water Clear
BH	InGaN	Brilliant Blue	

Absolute Maximum Ratings (Ta=25°C)

Parameter	Symbol	Code	Rating	Unit
Reverse Voltage	V_R		5	V
Forward Current	I_F	Y2	25	mA
		G6	25	
		BH	20	
Peak Forward Current (Duty 1/10 @1KHz)	I_{FP}	Y2	50	mA
		G6	50	
		BH	40	
Power Dissipation	P_d	Y2	60	mW
		G6	60	
		BH	75	
Electrostatic Discharge(HBM)	ESD	Y2	2000	V
		G6	2000	
		BH	150	
Operating Temperature	T_{opr}		-40 ~ +85	°C
Storage Temperature	T_{stg}		-40 ~ +90	°C
Soldering Temperature	T_{sol}		Reflow Soldering : 260 °C for 10 sec. Hand Soldering : 350 °C for 3 sec.	

Electro-Optical Characteristics (Ta=25°C)

Parameter	Symbol	Code	Min.	Typ.	Max.	Unit	Condition
Luminous Intensity	I _v	Y2	57.0	-----	140.0	mcd	
		G6	45.0	-----	112.0		
		BH	45.0	-----	112.0		
Viewing Angle	2θ _{1/2}		-----	120	-----	Deg	
Peak Wavelength	λ _p	Y2	-----	591	-----	nm	
		G6	-----	575	-----		
		BH	-----	468	-----		
Dominant Wavelength	λ _d	Y2	585.5	-----	594.0	nm	I _F =20mA
		G6	567.5	-----	575.5		
		BH	461.5	-----	473.5		
Spectrum Radiation Bandwidth	Δλ	Y2	-----	15	-----	nm	
		G6	-----	20	-----		
		BH	-----	25	-----		
Forward Voltage	V _F	Y2	1.7	2.0	2.4	V	
		G6	1.7	2.0	2.4		
		BH	2.7	3.3	3.7		
Reverse Current	I _R	Y2	-----	-----	10	μA	V _R =5V
		G6	-----	-----	10		
		BH	-----	-----	50		

Note:

- 1.Tolerance of Luminous Intensity: ±11%
- 2.Tolerance of Dominant Wavelength: ±1nm
3. RA test @ 5mA

Electro-Optical Characteristics (Ta=25°C)

Y2

Bin Code	Min.	Max.	Unit	Condition
PA	57.0	90.0	mcd	If=20mA
QA	90.0	140.0		

G6

Bin Code	Min.	Max.	Unit	Condition
P	45.0	72.0	mcd	If=20mA
Q	72.0	112.0		

BH

Bin Code	Min.	Max.	Unit	Condition
P	45.0	72.0	mcd	If=20mA
Q	72.0	112.0		

Note:

- 1.Tolerance of Luminous Intensity: ±11%
- 2.Tolerance of Dominant Wavelength: ±1nm

Y2

Bin Range Of Dom. Wavelength

Bin Code	Min.	Max.	Unit	Condition
D3	585.5	588.5	nm	I _F =20mA
D4	588.5	591.5		
D5	591.5	594.5		

G6

Bin Range Of Dom. Wavelength

Bin Code	Min.	Max.	Unit	Condition
C15	567.5	569.5	nm	I _F =20mA
C16	569.5	571.5		
C17	571.5	573.5		
C18	573.5	575.5		

BH

Bin Range Of Dom. Wavelength

Bin Code	Min.	Max.	Unit	Condition
A8	461.5	464.5	nm	I _F =20mA
A9	464.5	467.5		
A10	467.5	470.5		
A11	470.5	473.5		

Note:

- 1.Tolerance of Luminous Intensity: ±11%
- 2.Tolerance of Dominant Wavelength: ±1nm

Typical Electro-Optical Characteristics Curves

Y2

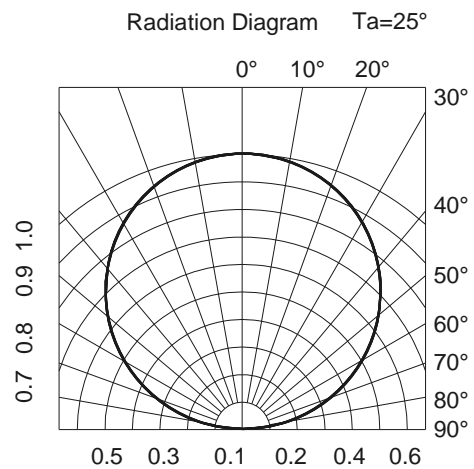
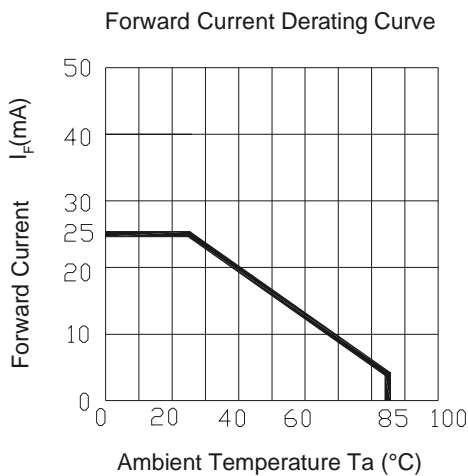
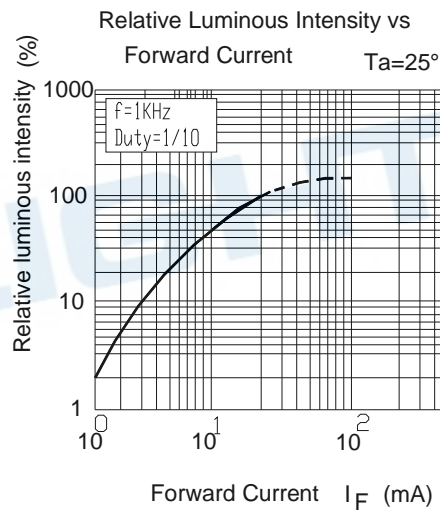
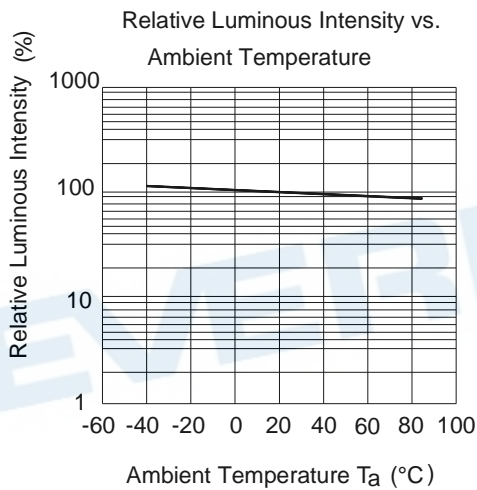
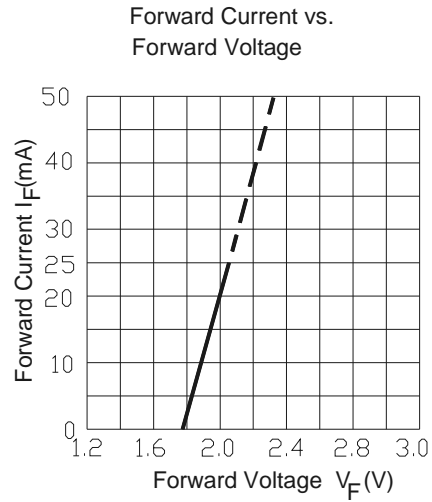
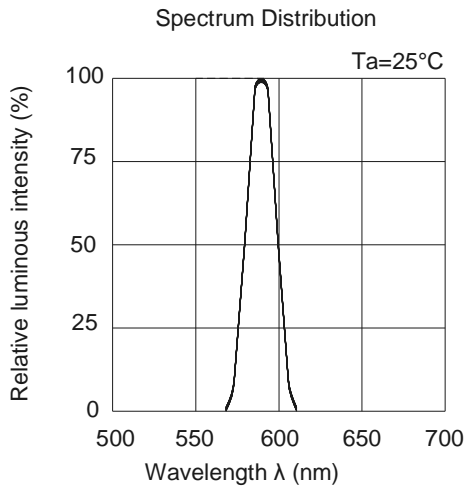

Typical Electro-Optical Characteristics Curves

G6

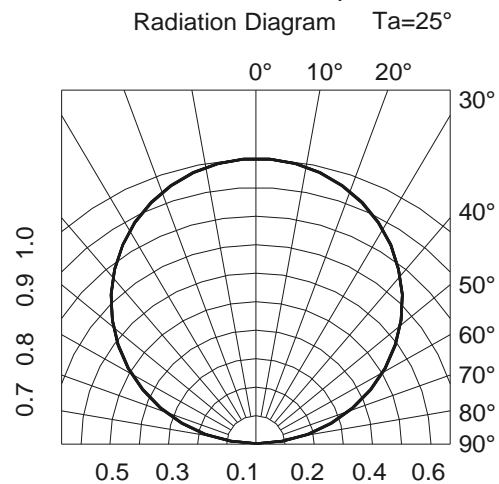
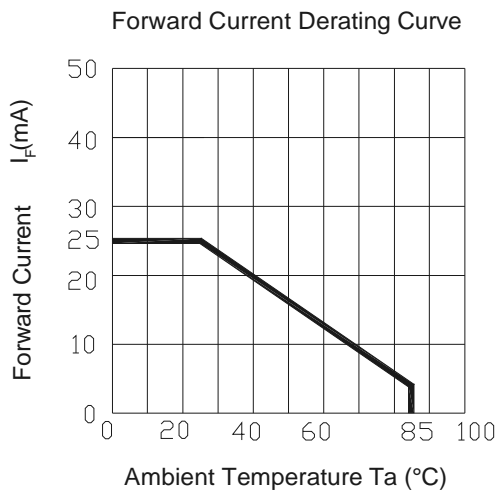
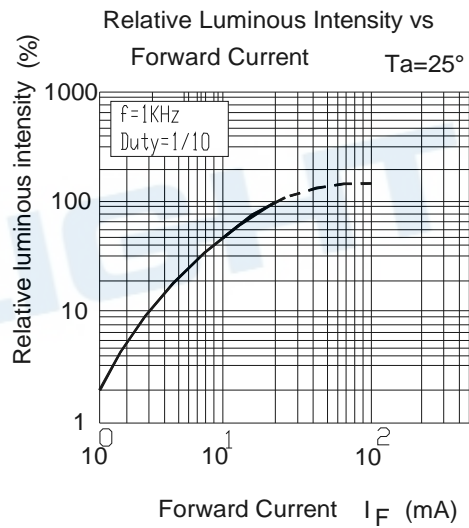
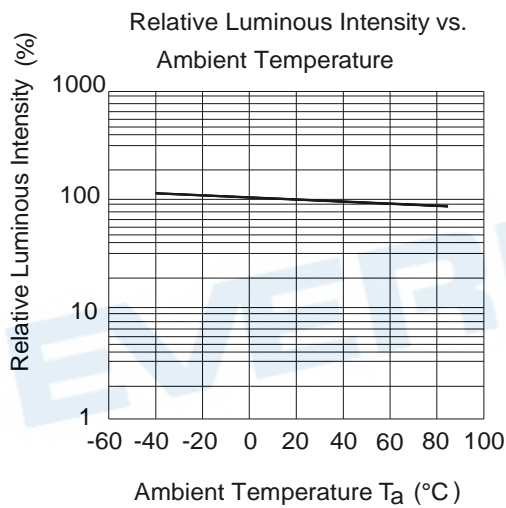
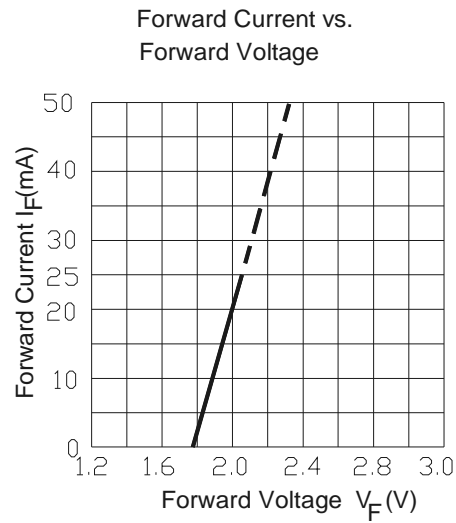
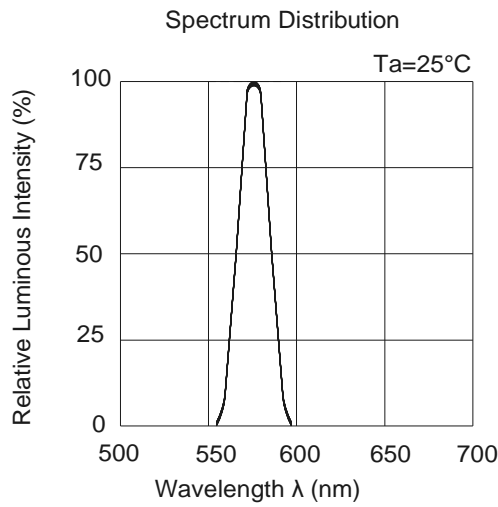

Typical Electro-Optical Characteristics Curves

BH

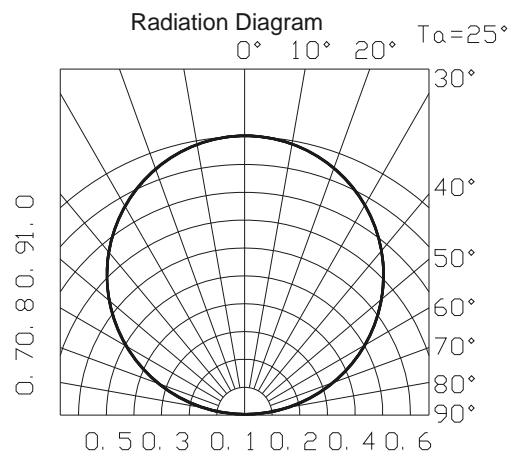
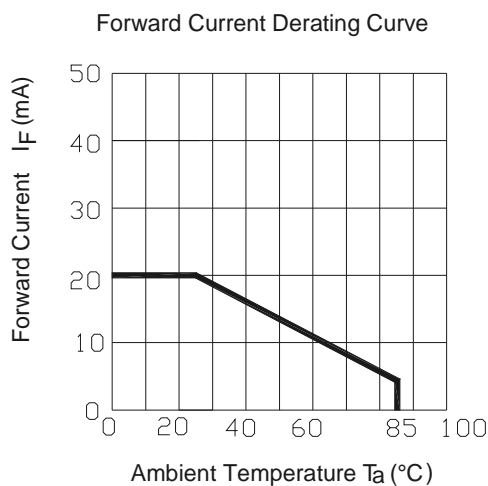
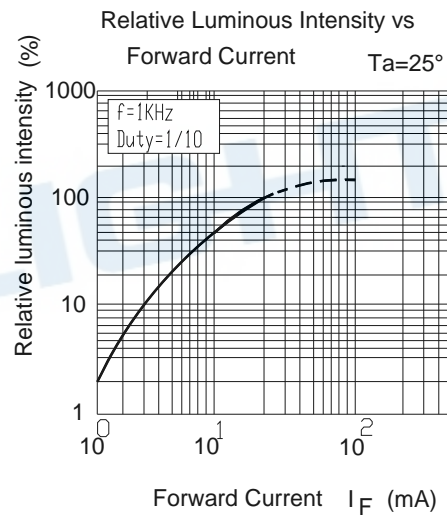
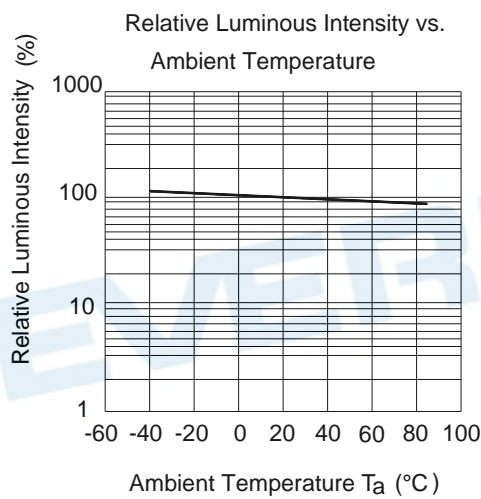
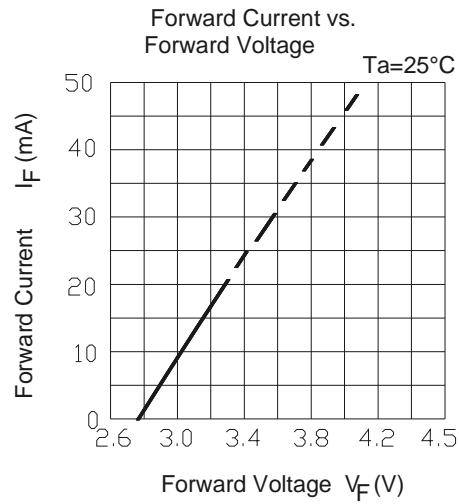
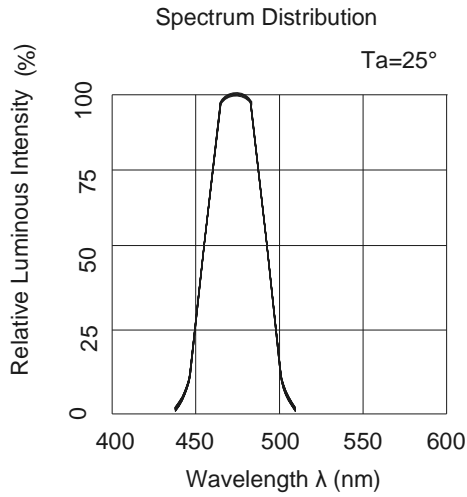

Package Dimension

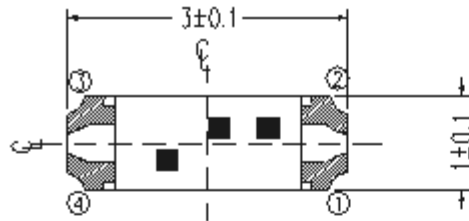

Top

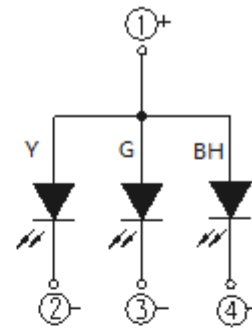

Polarity

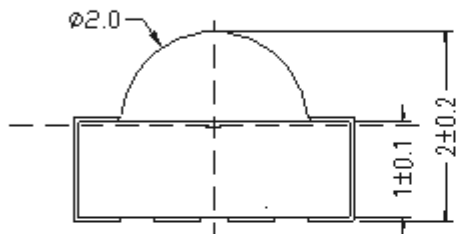

Side

Recommend Soldering Pad

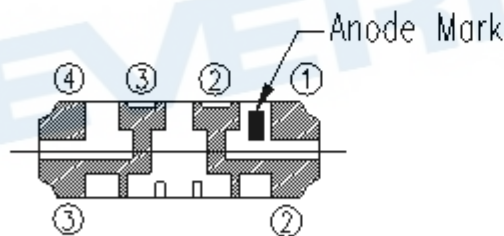

Bottom

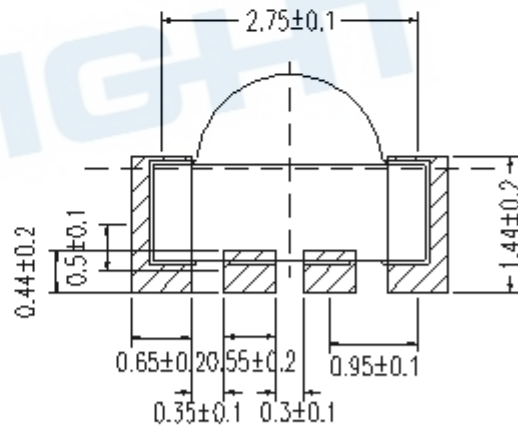

Suggested pad dimension is just for reference only.
Please modify the pad dimension based on individual need.

Note: Tolerances unless mentioned ± 0.1 mm. Unit = mm

Moisture Resistant Packing Materials

Label Explanation

RoHS Pb **EVERLIGHT** **5**

CPN: XXXXXXXXXXXXXXXXXXXX
 XXXXXXXXXXX-XXXXXXXXXX-XXXXXXXX-XXXXXX
 P/N: XXXXXXXXXXX
 XXXXXXXXXXX-XXXXXXXXXX-XXXXXXXX-XXXXXX
 LOT NO: Y150716XXX-XXXXXXXXXX-XXXXXXXXXX
 QTY: 0123456789 HUE: XXXXXXXXXXX
 CAT: XXXXXXXXXXX REF: XXXXXXXXXXX
 REFERENCE: BTPYYMDDXXXXX
 MSL-X MADE IN XXXXXX



- CPN: Customer's Product Number
- P/N: Product Number
- QTY: Packing Quantity
- CAT: Luminous Intensity Rank
- HUE: Chromaticity Coordinates & Dom. Wavelength Rank
- REF: Forward Voltage Rank
- LOT No: Lot Number

Reel Dimensions

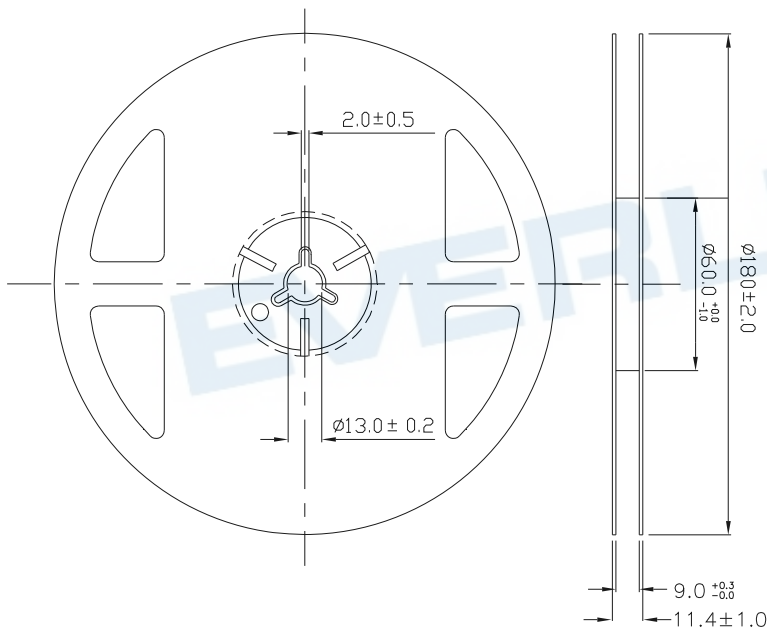

Note: The tolerances unless mentioned is $\pm 0.1\text{mm}$, Unit = mm

Carrier Tape Dimensions: Loaded quantity 2000 PCS per reel

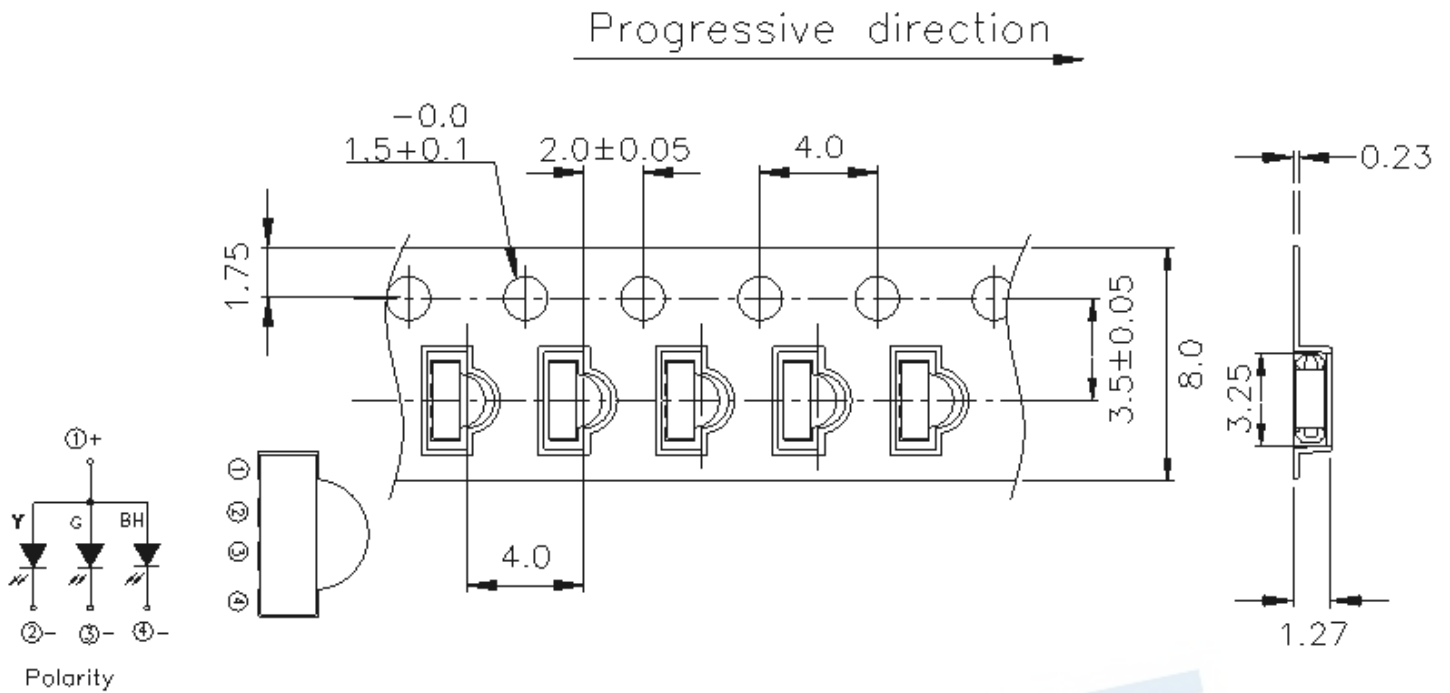

Note: The tolerances unless mentioned is $\pm 0.1\text{mm}$, Unit = mm

Moisture Resistant Packaging

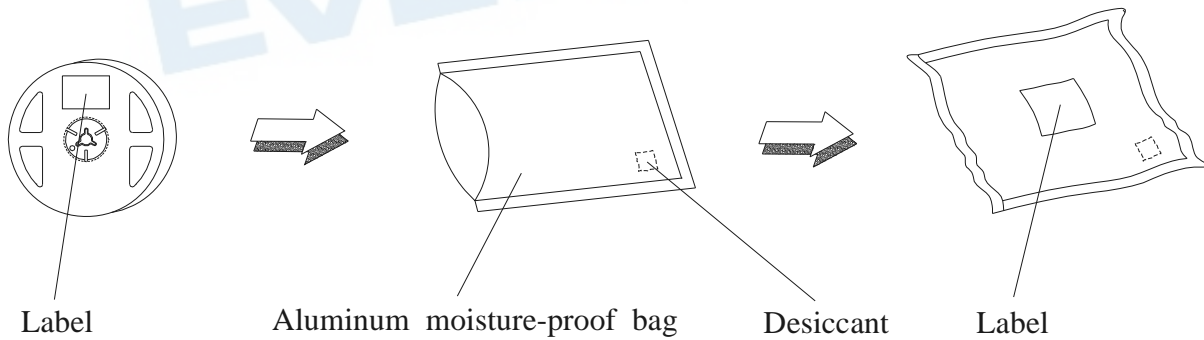

Precautions For Use

1. Over-current-proof

Customer must apply resistors for protection, otherwise slight voltage shift will cause big current change (Burn out will happen).

2. Storage

2.1 Do not open moisture proof bag before the products are ready to use.

2.2 After opening the package: The LEDs should be kept at 30°C or less and 60%RH or less.

2.3 The LEDs should be used within 168 hours (7days) after opening the package .

If unused LEDs remain, it should be stored in moisture proof packages.

2.4 If the moisture absorbent material (silica gel) has faded away or the LEDs have exceeded the storage time, baking treatment should be performed using the following conditions.

Baking treatment : 60±5°C for 24 hours.

3. Soldering Condition

3.1 Pb-free solder temperature profile

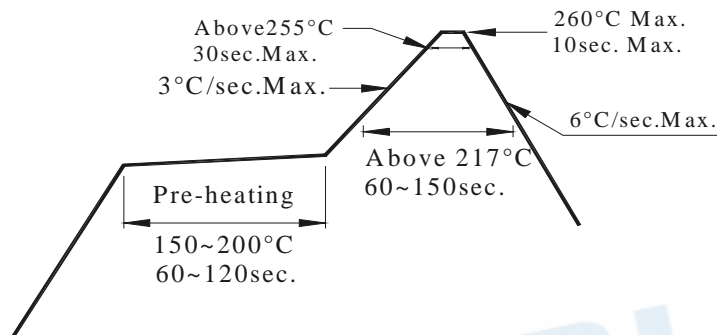

3.2 Reflow soldering should not be done more than two times.

3.3 When soldering, do not put stress on the LEDs during heating.

3.4 After soldering, do not warp the circuit board.

4. Soldering Iron

Each terminal is to go to the tip of soldering iron temperature less than 350°C for 3 seconds within once in less than the soldering iron capacity 25W. Leave two seconds and more intervals, and do soldering of each terminal. Be careful because the damage of the product is often started at the time of the hand solder.

5. Repairing

Repair should not be done after the LEDs have been soldered. When repairing is unavoidable, a double-head soldering iron should be used (as below figure). It should be confirmed beforehand whether the characteristics of the LEDs will or will not be damaged by repairing.

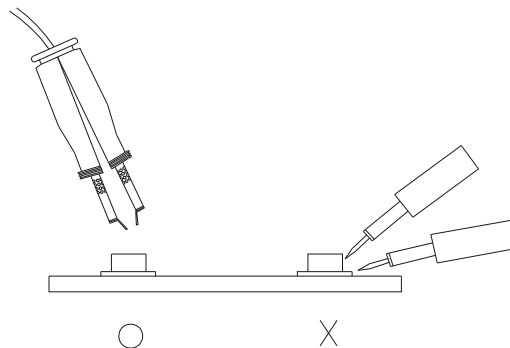

Application Restrictions

High reliability applications such as military/aerospace, automotive safety/security systems, and medical equipment may require different product. If you have any concerns, please contact Everlight before using this product in your application. This specification guarantees the quality and performance of the product as an individual component. Do not use this product beyond the specification described in this document.

DISCLAIMER

1. EVERLIGHT reserves the right(s) on the adjustment of product material mix for the specification.
2. The product meets EVERLIGHT published specification for a period of twelve (12) months from date of shipment.
3. The graphs shown in this datasheet are representing typical data only and do not show guaranteed values.
4. When using this product, please observe the absolute maximum ratings and the instructions for using outlined in these specification sheets. EVERLIGHT assumes no responsibility for any damage resulting from the use of the product which does not comply with the absolute maximum ratings and the instructions included in these specification sheets.
5. These specification sheets include materials protected under copyright of EVERLIGHT. Reproduction in any form is prohibited without obtaining EVERLIGHT's prior consent.
6. This product is not intended to be used for military, aircraft, automotive, medical, life sustaining or life saving applications or any other application which can result in human injury or death. Please contact authorized EVERLIGHT sales agent for special application request.

EVERLIGHT