

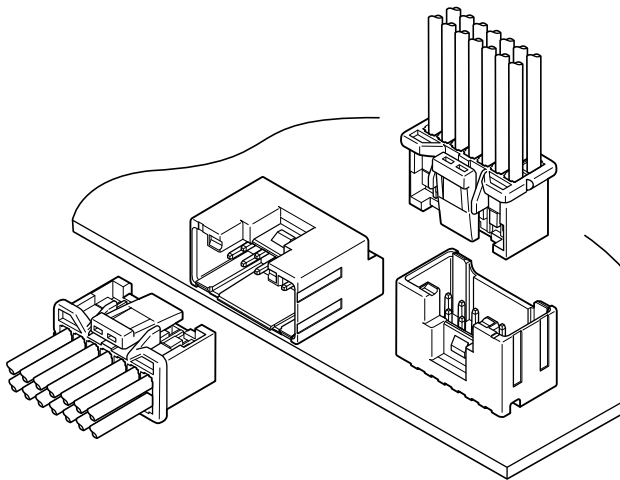

PUD CONNECTOR

2.0 mm pitch/Disconnectable Crimp style connectors



This is a board-to-wire connector with secure locking device that has been designed to 2.0 mm pitch, crimping style and double-row. In spite of realizing low insertion force, the stable electric connection is demonstrated against the condition such as vibration, pinching and dry circuit. It is possible to unfasten the locking even if the header is surrounded with a case wall within height of header because the tip of locking device in receptacle does not protrude from its area.

- High reliability contact
- Superior operability
- Secure locking structure
- Polarizing key for mounting on PC board

Specifications

- Current rating: 3 A AC/DC (AWG #22)
- Voltage rating: 250 V AC/ DC
- Temperature range: -25°C to +85°C
(including temperature rise in applying electrical current)
- Contact resistance: Initial value/ 10 mΩ max.
After environmental tests/ 20 mΩ max.
- Insulation resistance: 1,000 MΩ min.
- Withstanding voltage: 800 VAC/minute
- Applicable wire: Conductor size/ AWG #28 to #22
Insulation O.D./ 0.76 to 1.5 mm

* In using the products, refer to "Handling Precautions for Terminals and Connectors" described on our website (Technical documents of Product information page).

- * RoHS2 compliance
- * Dimensional unit: mm
- * Contact JST for details.

Standards

- Ⓜ Recognized E60389
- Ⓜ Certified LR20812

PC board layout and Assembly layout

Top entry type

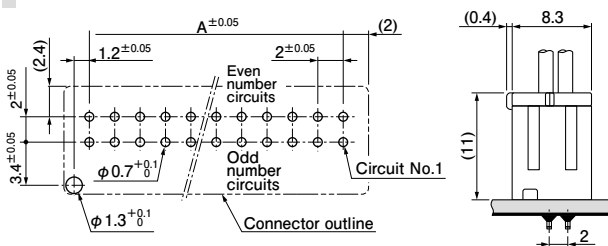

Side entry type

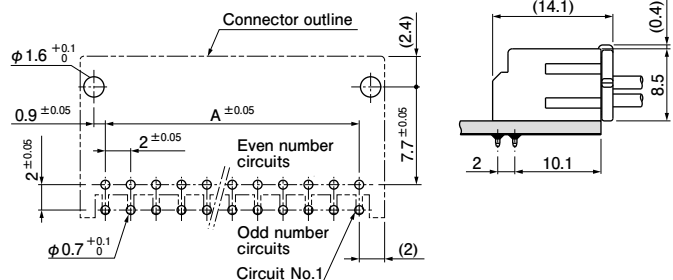

- Note: 1. The above figure is the figure viewed from the connector mounting side.
2. Tolerances are non-cumulative: ± 0.05 mm for all centers.
3. Hole dimensions differ according to the type of PC board and piercing method. The dimensions above should serve as a guideline. Contact JST for details.

SMT type

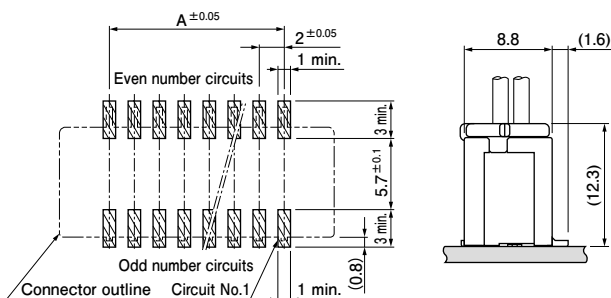

- Note: 1. The above figure is the figure viewed from the connector mounting side.
2. Tolerances are non-cumulative: ± 0.05 mm for all centers. The dimensions above should serve as a guideline. Contact JST for details.

PUD CONNECTOR

Contact

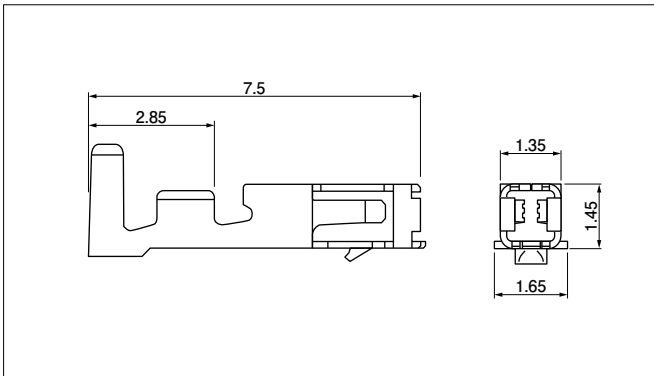

Model No.	Applicable wire		Insulation O.D. (mm)	Q'ty/reel
	mm ²	AWG #		
SPUD-001T-P0.5	0.13 to 0.33	26 to 22	0.95 to 1.5	8,000
SPUD-002T-P0.5	0.08 to 0.22	28 to 24	0.76 to 1.5	

Material and Finish

Copper alloy, tin-plated (reflow treatment)

RoHS2 compliance

Contact	Crimping machine	Applicator		
		Crimp applicator	Dies	Crimp applicator with dies
SPUD-001T-P0.5	AP-K2N	MKS-L	MK/SPUD-001-05	APLMK SPUD001-05
SPUD-002T-P0.5			MK/SPUD-002-05	APLMK SPUD002-05

Note: Contact JST for fully automatic crimping applicator.

Housing

<8, 10 circuits>

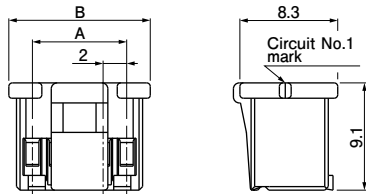

<12, 14 circuits>

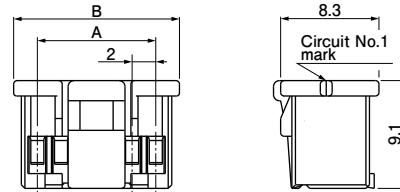

<16, 18 circuits>

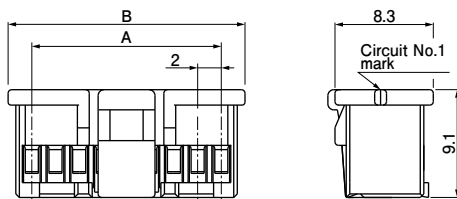

<20, 22 circuits>

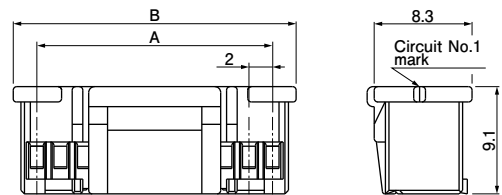

<24 to 28 circuits>

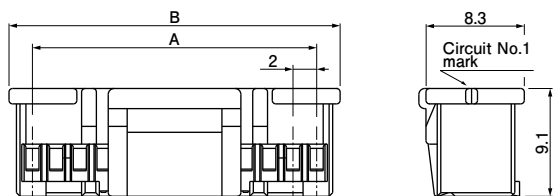

<30 to 40 circuits>

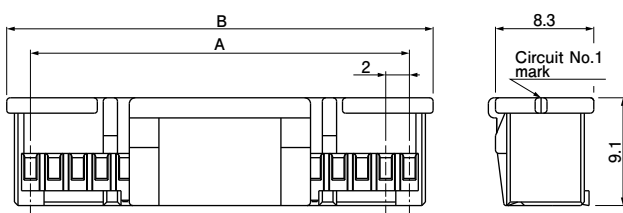

No. of circuits	Model No.	Dimensions (mm)		Q'ty/bag
		A	B	
8	PUDP-08V-S	6.0	10.0	1,000
10	PUDP-10V-S	8.0	12.0	1,000
12	PUDP-12V-S	10.0	14.0	1,000
14	PUDP-14V-S	12.0	16.0	1,000
16	PUDP-16V-S	14.0	18.0	1,000
18	PUDP-18V-S	16.0	20.0	1,000
20	PUDP-20V-S	18.0	22.0	1,000
22	PUDP-22V-S	20.0	24.0	1,000
24	PUDP-24V-S	22.0	26.0	1,000
26	PUDP-26V-S	24.0	28.0	1,000
28	PUDP-28V-S	26.0	30.0	500
30	PUDP-30V-S	28.0	32.0	500
32	PUDP-32V-S	30.0	34.0	500
34	PUDP-34V-S	32.0	36.0	500
36	PUDP-36V-S	34.0	38.0	500
38	PUDP-38V-S	36.0	40.0	500
40	PUDP-40V-S	38.0	42.0	500

Material and Finish

PBT, UL94V-0, natural

RoHS2 compliance

PUD CONNECTOR

Header (DIP type)

Top entry type

<8, 10 circuits>

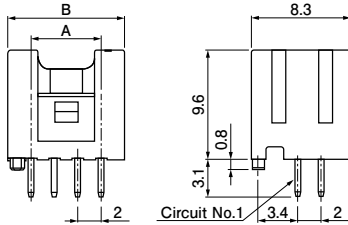

<12 to 18 circuits>

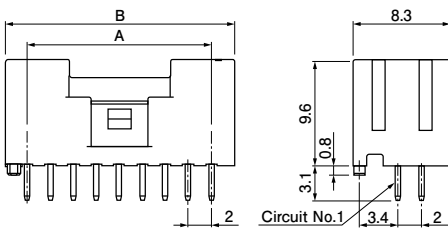

<20 to 40 circuits>

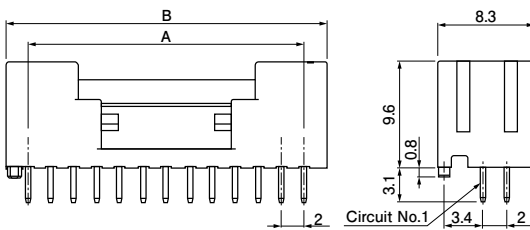

Side entry type

<8, 10 circuits>

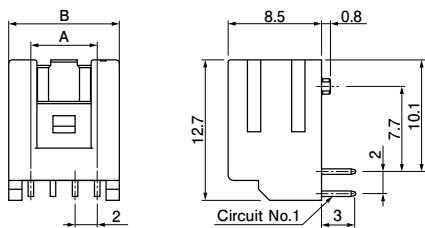

<12 to 18 circuits>

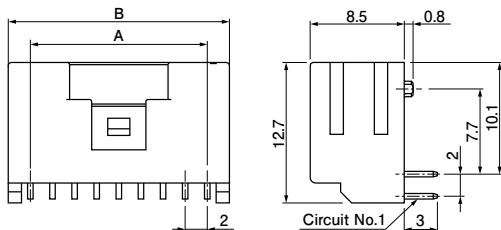

<20 to 40 circuits>

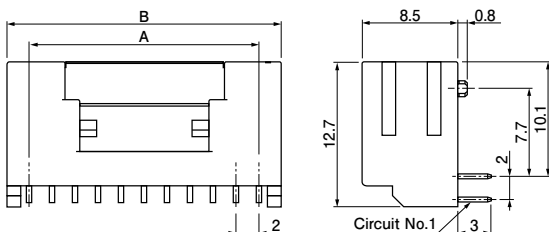

No. of circuits	Model No.			Dimensions (mm)		Q'ty/box
	Top entry type		Side entry type	A	B	
	Without boss	With boss	With boss			
8	B08B-PUDSS	B08B-PUDSS-1	S08B-PUDSS-1	6.0	10.0	3,300
10	B10B-PUDSS	B10B-PUDSS-1	S10B-PUDSS-1	8.0	12.0	2,750
12	B12B-PUDSS	B12B-PUDSS-1	S12B-PUDSS-1	10.0	14.0	2,310
14	B14B-PUDSS	B14B-PUDSS-1	S14B-PUDSS-1	12.0	16.0	1,980
16	B16B-PUDSS	B16B-PUDSS-1	S16B-PUDSS-1	14.0	18.0	1,760
18	B18B-PUDSS	B18B-PUDSS-1	S18B-PUDSS-1	16.0	20.0	1,650
20	B20B-PUDSS	B20B-PUDSS-1	S20B-PUDSS-1	18.0	22.0	1,430
22	B22B-PUDSS	B22B-PUDSS-1	S22B-PUDSS-1	20.0	24.0	1,320
24	B24B-PUDSS	B24B-PUDSS-1	S24B-PUDSS-1	22.0	26.0	1,210
26	B26B-PUDSS	B26B-PUDSS-1	S26B-PUDSS-1	24.0	28.0	1,100
28	B28B-PUDSS	B28B-PUDSS-1	S28B-PUDSS-1	26.0	30.0	1,100
30	B30B-PUDSS	B30B-PUDSS-1	S30B-PUDSS-1	28.0	32.0	990
32	B32B-PUDSS	B32B-PUDSS-1	S32B-PUDSS-1	30.0	34.0	880
34	B34B-PUDSS	B34B-PUDSS-1	S34B-PUDSS-1	32.0	36.0	880
36	B36B-PUDSS	B36B-PUDSS-1	S36B-PUDSS-1	34.0	38.0	770
38	B38B-PUDSS	B38B-PUDSS-1	S38B-PUDSS-1	36.0	40.0	770
40	B40B-PUDSS	B40B-PUDSS-1	S40B-PUDSS-1	38.0	42.0	770

Material and Finish

Post: Copper alloy, copper-undercoated, tin-plated (reflow treatment)
Wafer: Glass-filled PA 66, UL94V-0, natural

RoHS2 compliance This product displays (LF)(SN) on a label.

Note: Color indication was changed.

Berofe change; S··natural (ivory), After change; S··natural

PUD CONNECTOR

Header (SMT type)

<10 circuits>

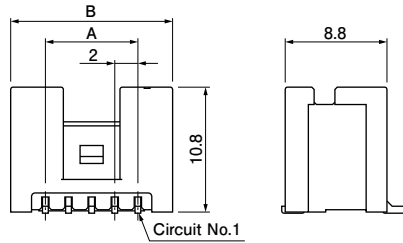

<12 to 18 circuits>

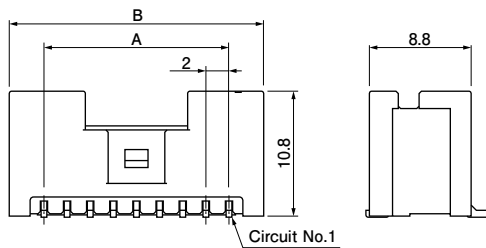

<20, 22 circuits>

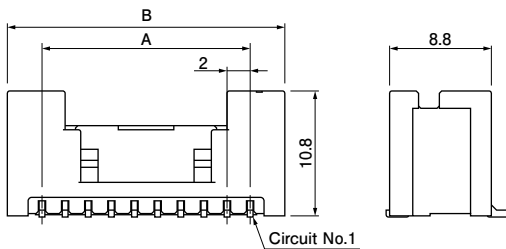

<24 to 28 circuits>

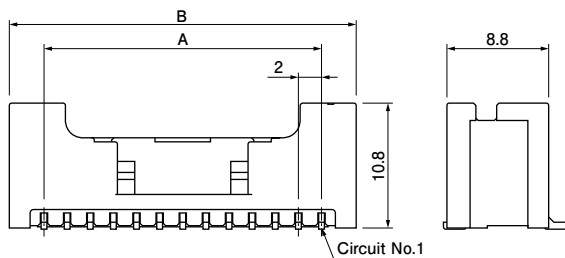

<30 to 40 circuits>

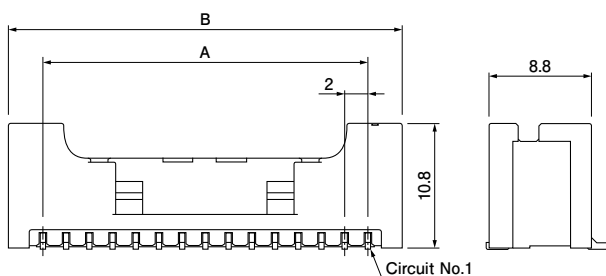

No. of circuits	Model No.	Dimensions (mm)		Q'ty/reel
		A	B	
10	BM10B-PUDSS-TFC	8.0	14.0	400
12	BM12B-PUDSS-TFC	10.0	16.0	400
14	BM14B-PUDSS-TFC	12.0	18.0	400
16	BM16B-PUDSS-TFC	14.0	20.0	400
18	BM18B-PUDSS-TFC	16.0	22.0	400
20	BM20B-PUDSS-TFC	18.0	24.0	400
22	BM22B-PUDSS-TFC	20.0	26.0	400
24	BM24B-PUDSS-TFC	22.0	28.0	400
26	BM26B-PUDSS-TFC	24.0	30.0	400
28	BM28B-PUDSS-TFC	26.0	32.0	400
30	BM30B-PUDSS-TFC	28.0	34.0	400
32	BM32B-PUDSS-TFC	30.0	36.0	400
34	BM34B-PUDSS-TFC	32.0	38.0	400
36	BM36B-PUDSS-TFC	34.0	40.0	400
38	BM38B-PUDSS-TFC	36.0	42.0	400
40	BM40B-PUDSS-TFC	38.0	44.0	400

Material and Finish

Post: Copper alloy, copper-undercoated, tin-plated (reflow treatment)
Wafer: Polyamide, UL94V-0, natural

RoHS2 compliance This product displays (LF)(SN) on a label.

PUD CONNECTOR

Model number allocation

Contact

S PUD - 001 T - P 0.5

Form: S...Strip form
Series name
Applicable wire range: 001...AWG #26 to #22 002...AWG #28 to #24
Surface finish: T...Tin-plated (reflow treatment)
Material: P...Copper alloy
Terminal size

Housing

PUD P - 08 V - S

Series name
Part name: Plug
No. of circuits: Even number of circuits from 8 to 40
Flammability: V...UL94V-0
Color: S...Natural, Z...Ivory, E...Blue, R...Red, K...Black, TR...Tomato red, MG...Moss green, DPK...Dark pink, CB...Cobalt blue, DO...Dark orange, DP...Dark purple, DH...Dark gray, LE...Light blue

Header (DIP type)

B 08 B - PUD S S - 1

Shape of assembled product: B...Top entry type, S...Side entry type
No. of circuits: Top entry type...Even number of circuits from 8 to 40 Side entry type...Even number of circuits from 8 to 40
Part name: Header
Series name
Color: S...Natural, Z...Ivory, E...Blue, R...Red, K...Black, TR...Tomato red, MG...Moss green, DPK...Dark pink, CB...Cobalt blue, DO...Dark orange, DP...Dark purple, DH...Dark gray, LE...Light blue
Indication of clinch: S...Straight pin
Shape: None...Without boss, 1...With boss

Header (SMT type)

BM 10 B - PUD S S - TF C

Shape of assembled product: BM...Top entry type
No. of circuits: Even number of circuits from 10 to 40
Part name: Header
Series name
Color: S...Natural, Z...Ivory, K...Black, TR...Tomato red, MG...Moss green, DPK...Dark pink, CB...Cobalt blue, DO...Dark orange, DP...Dark purple, DH...Dark gray, LE...Light blue
Indication of clinch: S...Straight pin
Packaging style: TF...Embossed-taping
Suction tape: C...With suction tape