

Features

- Enhancement mode
- Ultra low on-resistance
- VitoMOS[®] II Technology
- Fast Switching and High efficiency
- 100% Avalanche tested, 100% Rg tested



Part ID	Package Type	Marking	Packing
VS3602GPMT	PDFN5x6	3602GPM	3000PCS/Reel

V_{DS}	30	V
$R_{DS(on),TYP@ V_{GS}=10V}$	0.6	mΩ
$R_{DS(on),TYP@ V_{GS}=4.5V}$	0.9	mΩ
$I_D(\text{Silicon Limited})$	440	A
$I_D(\text{Package Limited})$	200	A

PDFN5x6

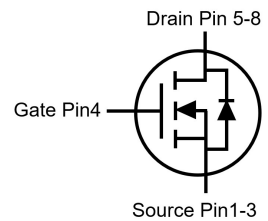
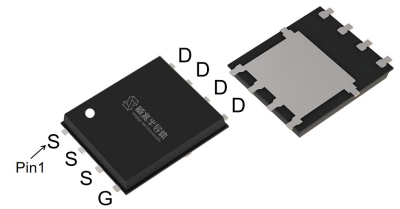

Maximum ratings, at $T_A = 25^\circ\text{C}$, unless otherwise specified

Symbol	Parameter		Rating	Unit
$V_{(BR)DSS}$	Drain-Source breakdown voltage		30	V
V_{GS}	Gate-Source voltage		± 20	V
I_S	Diode continuous forward current	$T_C = 25^\circ\text{C}$	440	A
I_D	Continuous drain current @ $V_{GS}=10V$ (Silicon limited)	$T_C = 25^\circ\text{C}$	440	A
I_D	Continuous drain current @ $V_{GS}=10V$ (Silicon limited)	$T_C = 100^\circ\text{C}$	278	A
I_D	Continuous drain current @ $V_{GS}=10V$ (Package limited)	$T_C = 25^\circ\text{C}$	200	A
I_{DM}	Pulse drain current tested ①	$T_C = 25^\circ\text{C}$	1150	A
I_{DSM}	Continuous drain current @ $V_{GS}=10V$	$T_A = 25^\circ\text{C}$	46	A
		$T_A = 70^\circ\text{C}$	37	A
E_{AS}	Avalanche energy, single pulsed ②		1225	mJ
P_D	Maximum power dissipation ③	$T_C = 25^\circ\text{C}$	240	W
		$T_C = 100^\circ\text{C}$	96	W
P_{DSM}	Maximum power dissipation ④	$T_A = 25^\circ\text{C}$	2.6	W
		$T_A = 70^\circ\text{C}$	1.7	W
$T_{STG,TJ}$	Storage and Junction Temperature Range		-55 to 150	$^\circ\text{C}$

Thermal Characteristics

Symbol	Parameter	Typical	Max	Unit
$R_{\theta JC}$	Thermal Resistance, Junction-to-Case ⑤	0.43	0.52	$^\circ\text{C/W}$
$R_{\theta JA}$	Thermal Resistance, Junction-to-Ambient ⑥	40	48	$^\circ\text{C/W}$

Electrical Characteristics

Symbol	Parameter	Condition	Min.	Typ.	Max.	Unit
Static Electrical Characteristics @ T_j=25°C (unless otherwise stated)						
V(BR)DSS	Drain-Source Breakdown Voltage	V _{GS} =0V, I _D =250μA	30	--	--	V
IDSS	Zero Gate Voltage Drain Current(T _j =25°C)	V _{DS} =30V, V _{GS} =0V	--	--	1	μA
	Zero Gate Voltage Drain Current(T _j =125°C) ^⑦	V _{DS} =30V, V _{GS} =0V	--	--	100	μA
IGSS	Gate-Body Leakage Current	V _{GS} =±20V, V _{DS} =0V	--	--	±100	nA
V _{GS(th)}	Gate Threshold Voltage	V _{DS} =V _{GS} , I _D =250μA	1.3	1.8	2.4	V
R _{DS(on)}	Drain-Source On-State Resistance ^⑧	V _{GS} =10V, I _D =40A	--	0.6	0.8	mΩ
		(T _j =100°C) ^⑦	--	0.8	--	mΩ
R _{DS(on)}	Drain-Source On-State Resistance ^⑧	V _{GS} =4.5V, I _D =30A	--	0.9	1.2	mΩ
Dynamic Electrical Characteristics @ T_j = 25°C (unless otherwise stated)						
C _{iss}	Input Capacitance ^⑦	V _{DS} =15V, V _{GS} =0V, f=1MHz	--	8540	--	pF
C _{oss}	Output Capacitance ^⑦		--	4395	--	pF
C _{rss}	Reverse Transfer Capacitance ^⑦		--	240	--	pF
R _g	Gate Resistance	f=1MHz	--	4.7	--	Ω
Q _{g(10V)}	Total Gate Charge ^⑦	V _{DS} =15V, I _D =40A, V _{GS} =10V	--	112	--	nC
Q _{g(4.5V)}	Total Gate Charge ^⑦		--	53	--	nC
Q _{gs}	Gate-Source Charge ^⑦		--	23	--	nC
Q _{gd}	Gate-Drain Charge ^⑦		--	14	--	nC
Switching Characteristics ^⑦						
T _{d(on)}	Turn-on Delay Time	V _{DD} =15V, I _D =40A, R _G =3Ω, V _{GS} =10V	--	9.4	--	ns
T _r	Turn-on Rise Time		--	105	--	ns
T _{d(off)}	Turn-Off Delay Time		--	142	--	ns
T _f	Turn-Off Fall Time		--	75	--	ns
Source- Drain Diode Characteristics @ T_j = 25°C (unless otherwise stated)						
V _{SD}	Forward on voltage	I _{SD} =40A, V _{GS} =0V	--	0.9	1.2	V
T _{rr}	Reverse Recovery Time ^⑦	I _{SD} =40A, V _{GS} =0V di/dt=100A/μs	--	59	--	ns
Q _{rr}	Reverse Recovery Charge ^⑦		--	50	--	nC

NOTE:

- ① Single pulse; pulse width ≤ 100μs.
- ② EAS of 1225mJ is based on starting T_J = 25°C, L = 0.5mH, R_G = 25Ω, I_{AS} = 70A, V_{GS} = 10V; 100% FT tested at L = 0.5mH, I_{AS} = 35A.
- ③ The power dissipation P_d is based on T_{J(max)}, using junction-to-case thermal resistance R_{θJC}.
- ④ The power dissipation P_{dsm} is based on T_{J(max)}, using junction-to-ambient thermal resistance R_{θJA}.
- ⑤ Thermal resistance from junction to soldering point (on the exposed drain pad).
- ⑥ These tests are performed with the device mounted on 1 in2 FR-4 board with 2oz. Copper, in a still air environment with T_A=25°C.
- ⑦ Guaranteed by design, not subject to production testing.
- ⑧ Pulse width ≤ 380μs; duty cycles ≤ 2%.

Typical Characteristics

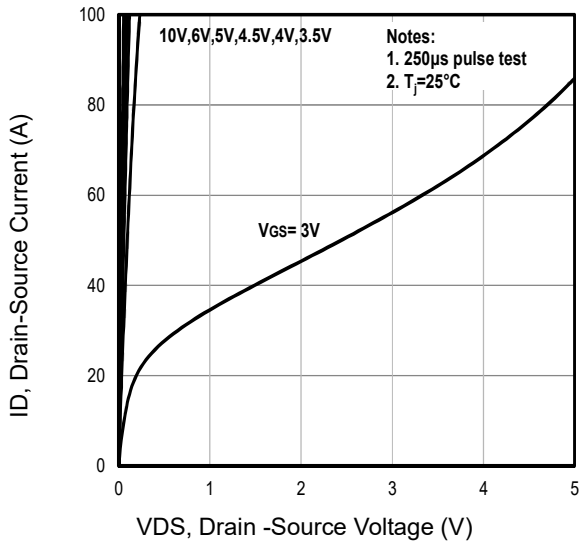

Fig1. Typical Output Characteristics

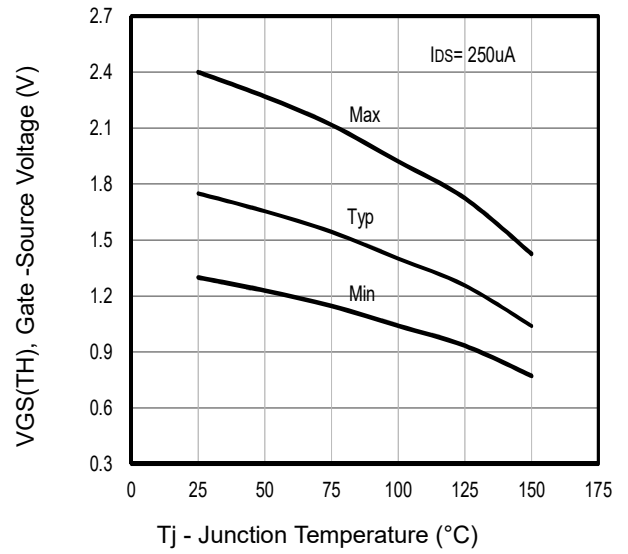

Fig2. Typical $V_{GS(TH)}$ Gate-Source Voltage Vs. T_j

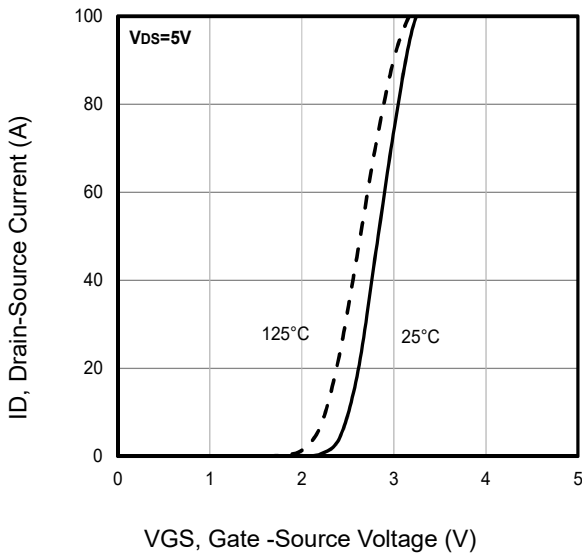

Fig3. Typical Transfer Characteristics

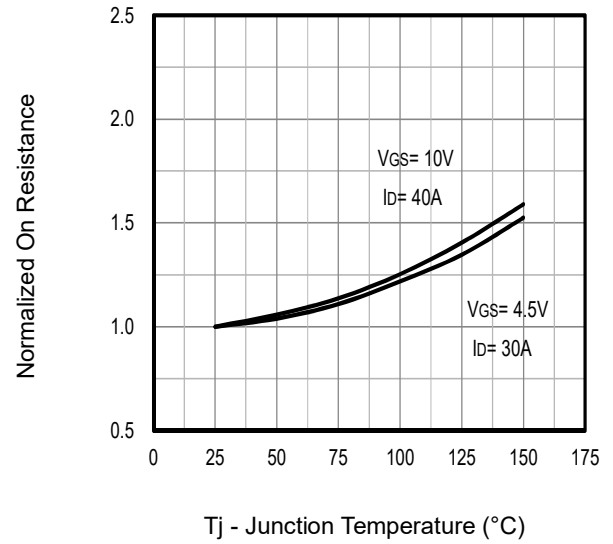

Fig4. Typical Normalized On-Resistance Vs. T_j

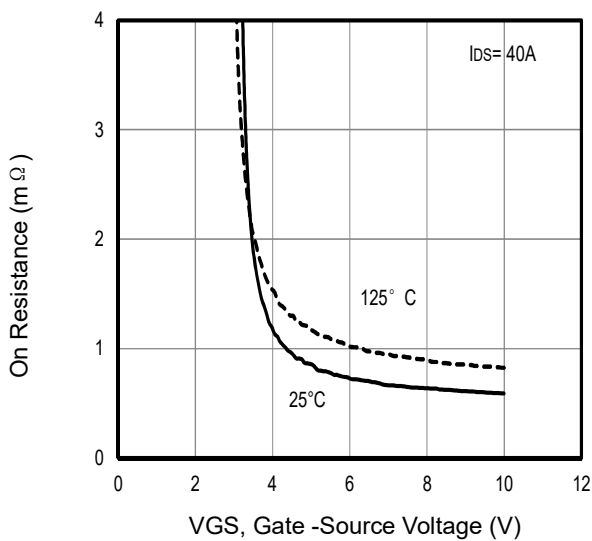

Fig5. Typical On Resistance Vs Gate-Source Voltage

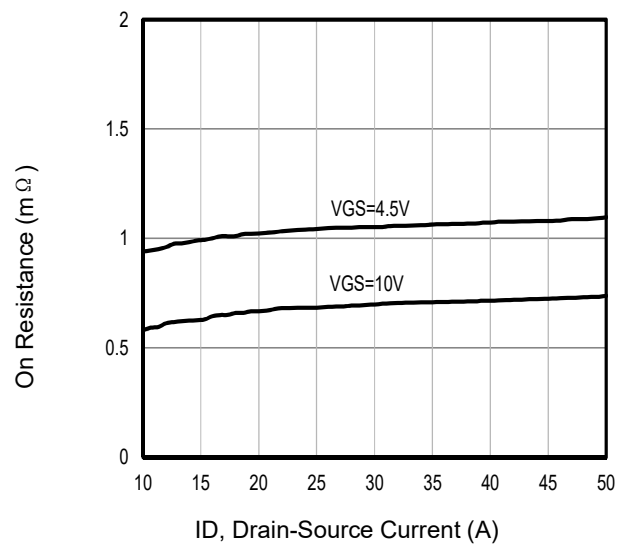

Fig6. Typical On Resistance Vs Drain Current

Typical Characteristics

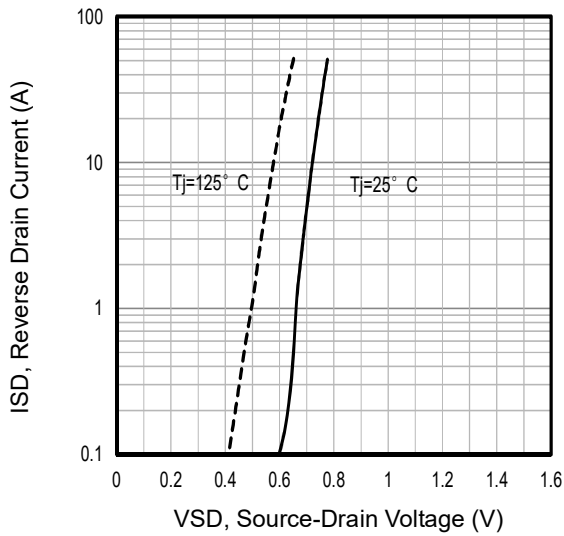

Fig7. Typical Source-Drain Diode Forward Voltage

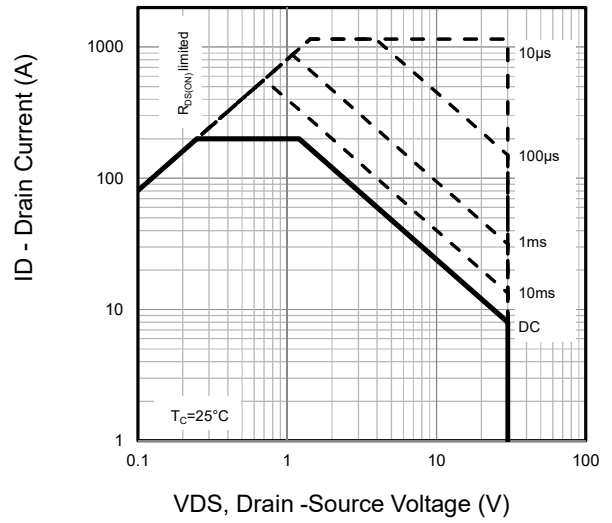

Fig8. Maximum Safe Operating Area

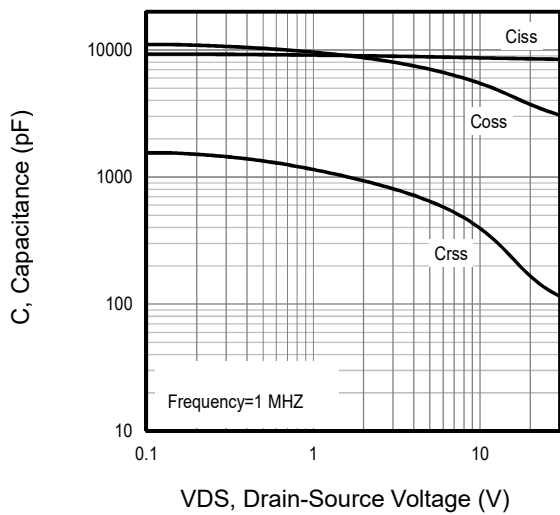

Fig9. Typical Capacitance Vs. Drain-Source Voltage

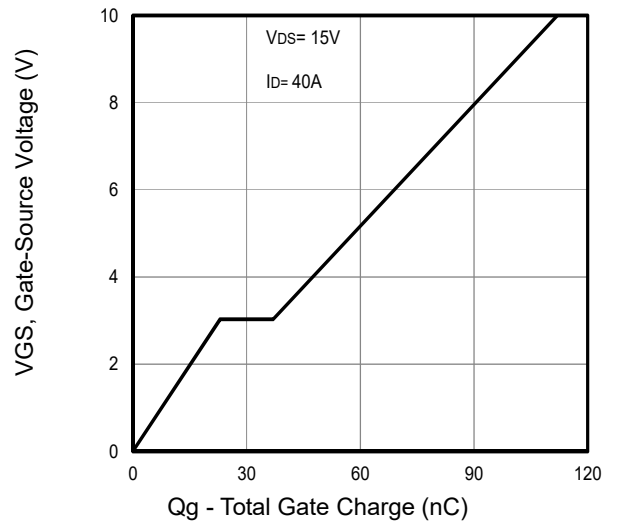

Fig10. Typical Gate Charge Vs. Gate-Source Voltage

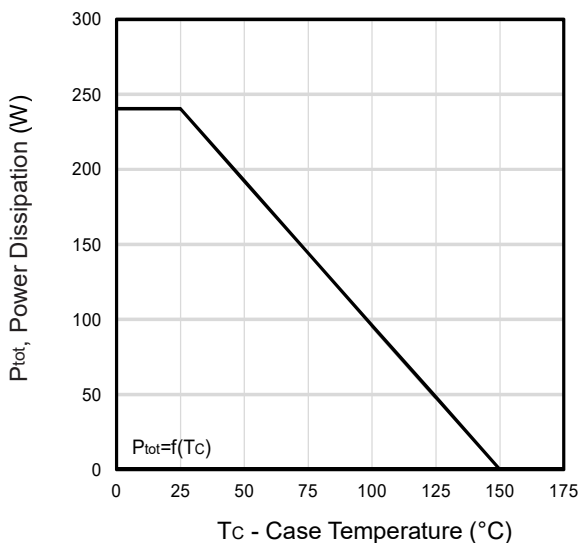

Fig11. Power Dissipation Vs. Case Temperature

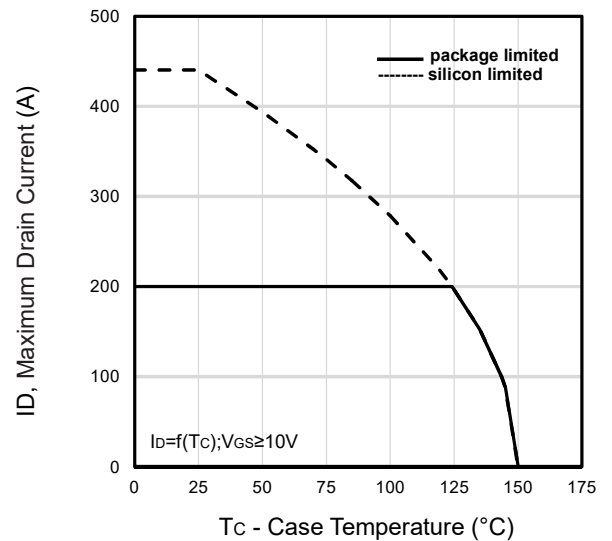

Fig12. Maximum Drain Current Vs. Case Temperature

Typical Characteristics

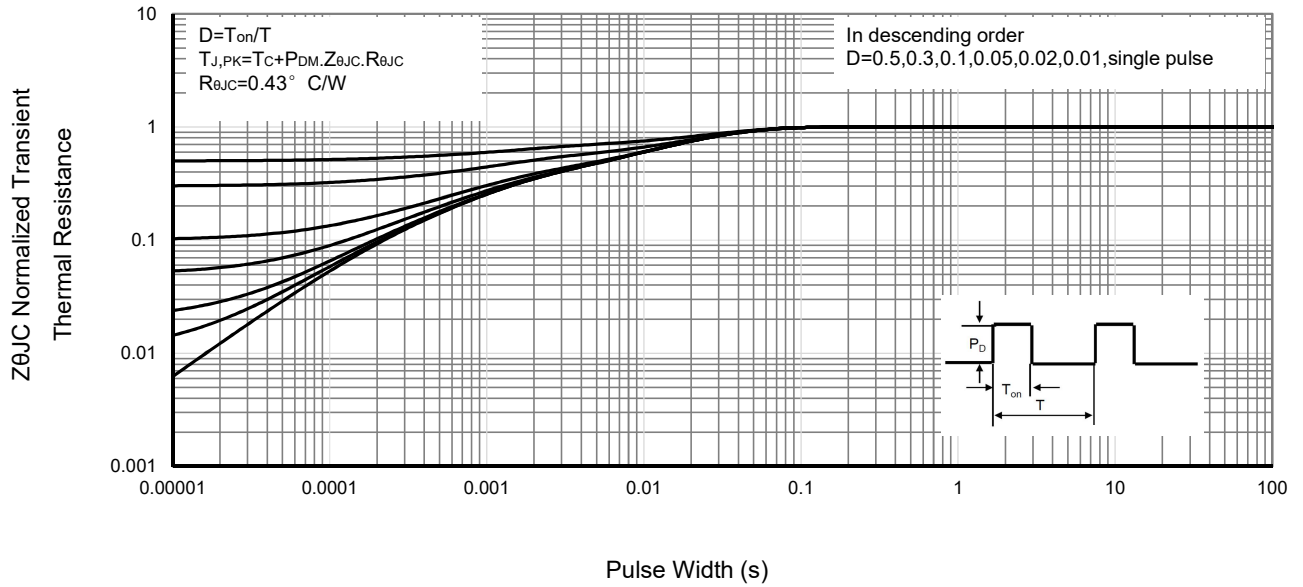

Fig13 . Normalized Maximum Transient Thermal Impedance

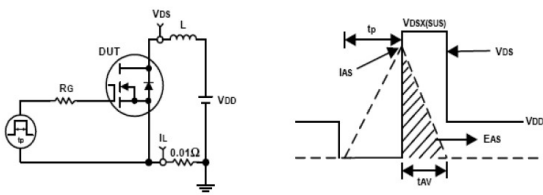

Fig14. Unclamped Inductive Test Circuit and waveforms

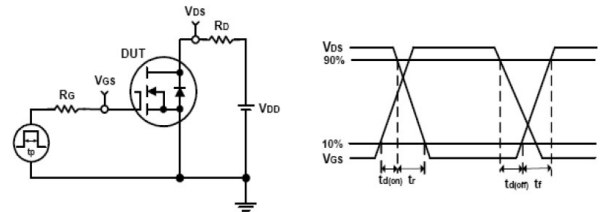
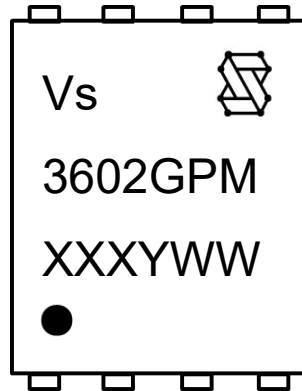

Fig15. Switching Time Test Circuit and waveforms

Marking Information



1st line: Vergiga Code (Vs) , Vergiga Logo

2nd line: Part Number (3602GPM)

3rd line: Date code (XXXYWW)

XXX: Wafer Lot Number Code, code changed with Lot Number

Y: Year Code , refer to table below

WW: Week Code (01 to 53)

Code	C	D	E	F	G	H	J	K	L	M	N	P	Q	R	S	T
Year	2015	2016	2017	2018	2019	2020	2021	2022	2023	2024	2025	2026	2027	2028	2029	2030

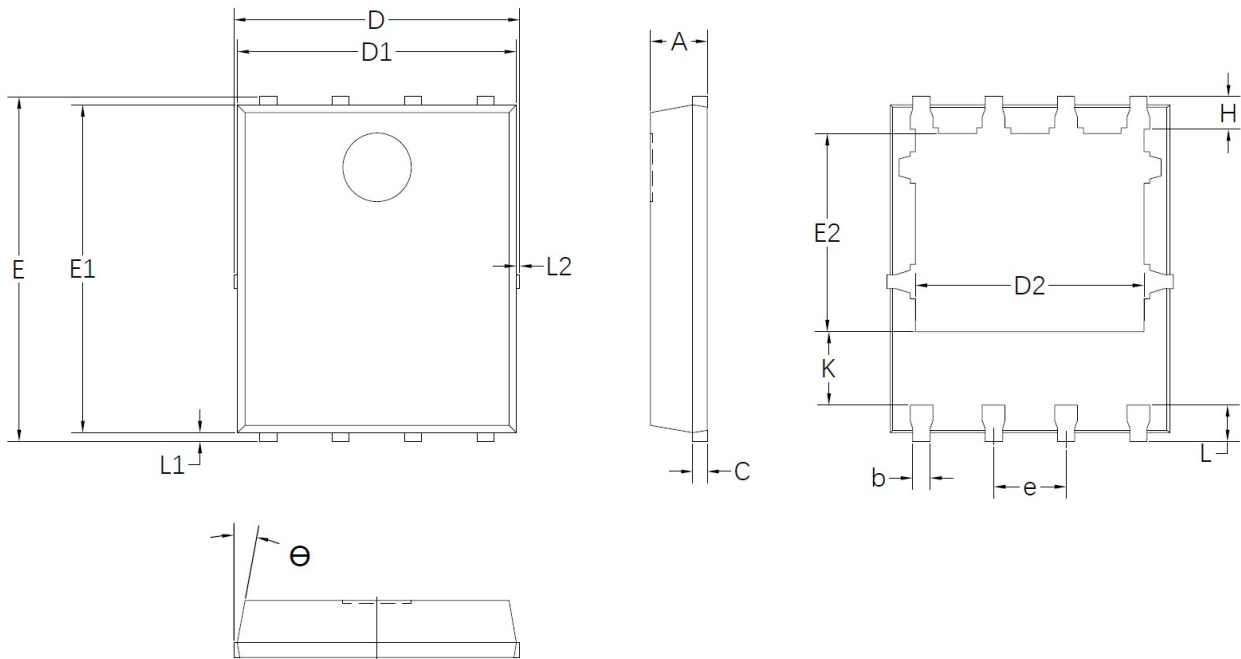
PDFN5x6 Package Outline Data

Symbol	DIMENSIONS (unit : mm)		
	Min	Typ	Max
A	0.90	1.00	1.10
b	0.35	0.40	0.45
C	0.21	0.25	0.34
D	--	--	5.10
D1	4.80	4.90	5.00
D2	3.91	4.01	4.11
e	1.27 BSC		
E	5.90	6.00	6.10
E1	5.70	5.75	5.80
E2	3.375	3.475	3.575
H	0.55	0.65	0.75
K	1.29	--	--
L	0.55	0.65	0.75
L1	0.05	0.15	0.25
L2	--	--	0.12
θ	8°	10°	12°

Notes:

1. Refer to JEDEC MO-240 variation AA.
2. Dimensions "D1" and "E1" do NOT include mold flash protrusions or gate burrs.
3. Dimensions "D1" and "E1" include interterminal flash or protrusion. Interterminal flash or protrusion shall not exceed 0.25mm per side.

Customer Service
Sales and Service:
sales@vgsemi.com
Vergiga Semiconductor CO., LTD
TEL: (86-755) -26902410

FAX: (86-755) -26907027

WEB: www.vgsemi.com