

Features

- P-Channel, -5V Logic Level Control
- Enhancement mode
- Low on-resistance $R_{DS(on)}$ @ $V_{GS}=-4.5\text{ V}$
- Pb-free lead plating; RoHS compliant

V_{DS}	-30	V
$R_{DS(on),TYP}@ V_{GS}=-10\text{ V}$	11	m Ω
$R_{DS(on),TYP}@ V_{GS}=-4.5\text{ V}$	18	m Ω
I_D	-14	A



Part ID	Package Type	Marking	Packing
VS3510AS	SOP8	3510AS	3000PCS/Reel

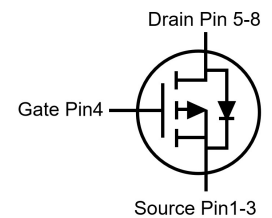
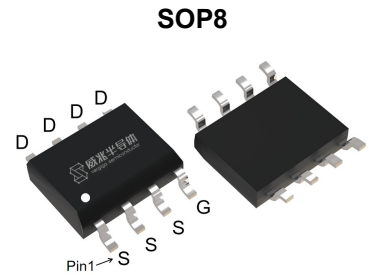

Maximum ratings, at $T_A=25^\circ\text{C}$, unless otherwise specified

Symbol	Parameter	Rating	Unit
$V_{(BR)DSS}$	Drain-Source breakdown voltage	-30	V
V_{GS}	Gate-Source voltage	± 25	V
I_S	Diode continuous forward current	$T_A=25^\circ\text{C}$ -2.6	A
I_D	Continuous drain current @ $V_{GS}=-10\text{V}$	$T_A=25^\circ\text{C}$ -14	A
		$T_A=100^\circ\text{C}$ -9	A
I_{DM}	Pulse drain current tested ①	$T_A=25^\circ\text{C}$ -56	A
P_D	Maximum power dissipation	$T_A=25^\circ\text{C}$ 3.1	W
MSL		Level 3	
T_{STG}, T_J	Storage and junction temperature range	-55 to 150	$^\circ\text{C}$

Thermal Characteristics

Symbol	Parameter	Typical	Unit
$R_{\theta JL}$	Thermal Resistance, Junction-to-Lead	24	$^\circ\text{C/W}$
$R_{\theta JA}$	Thermal Resistance, Junction-to-Ambient	40	$^\circ\text{C/W}$

Electrical Characteristics

Symbol	Parameter	Condition	Min.	Typ.	Max.	Unit
Static Electrical Characteristics @ T_j=25°C (unless otherwise stated)						
V _{(BR)DSS}	Drain-Source Breakdown Voltage	V _{GS} =0V, I _D =-250μA	-30	--	--	V
I _{DSS}	Zero Gate Voltage Drain Current	V _{DS} =-30V, V _{GS} =0V	--	--	-1	μA
	Zero Gate Voltage Drain Current(T _j =125°C)	V _{DS} =-30V, V _{GS} =0V	--	--	-100	μA
I _{GSS}	Gate-Body Leakage Current	V _{GS} =±25V, V _{DS} =0V	--	--	±100	nA
V _{GS(TH)}	Gate Threshold Voltage	V _{DS} =V _{GS} , I _D =-250μA	-1.2	-1.9	-2.4	V
R _{DS(ON)}	Drain-Source On-State Resistance ^②	V _{GS} =-10V, I _D =-10A	--	11	14	mΩ
R _{DS(ON)}	Drain-Source On-State Resistance ^②	V _{GS} =-4.5V, I _D =-6A	--	18	23	mΩ
Dynamic Electrical Characteristics @ T_j = 25°C (unless otherwise stated)						
C _{iss}	Input Capacitance	V _{DS} =-15V, V _{GS} =0V, f=1MHz	1625	1915	2200	pF
C _{oss}	Output Capacitance		255	300	345	pF
C _{rss}	Reverse Transfer Capacitance		180	210	240	pF
R _g	Gate Resistance	f=1MHz	--	4.8	--	Ω
Q _g	Total Gate Charge	V _{DS} =-15V, I _D =-10A, V _{GS} =-10V	--	39	--	nC
Q _{gs}	Gate-Source Charge		--	7	--	nC
Q _{gd}	Gate-Drain Charge		--	13	--	nC
Switching Characteristics						
t _{d(on)}	Turn-on Delay Time	V _{DD} =-15V, I _D =-10A, R _G =3Ω, V _{GS} =-10V	--	10	--	ns
t _r	Turn-on Rise Time		--	10.6	--	ns
t _{d(off)}	Turn-Off Delay Time		--	31	--	ns
t _f	Turn-Off Fall Time		--	10	--	ns
Source- Drain Diode Characteristics@ T_j = 25°C (unless otherwise stated)						
V _{SD}	Forward on voltage	I _{SD} =-10A, V _{GS} =0V	--	-0.8	-1.2	V
t _{rr}	Reverse Recovery Time	T _j =25°C, I _{SD} =-10A, V _{GS} =0V	--	16	--	ns
Q _{rr}	Reverse Recovery Charge	di/dt=-500A/μs	--	42	--	nC

NOTE:

- ① Repetitive rating; pulse width limited by max. junction temperature.
 ② Pulse width ≤ 300μs; duty cycle ≤ 2%.

Typical Characteristics

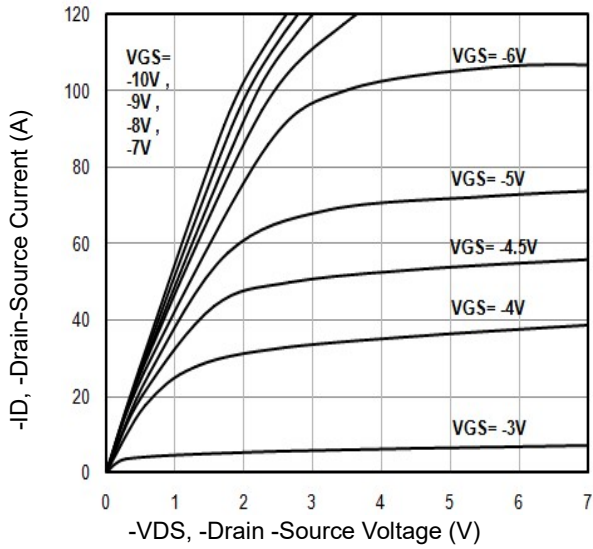

Fig1. Typical Output Characteristics

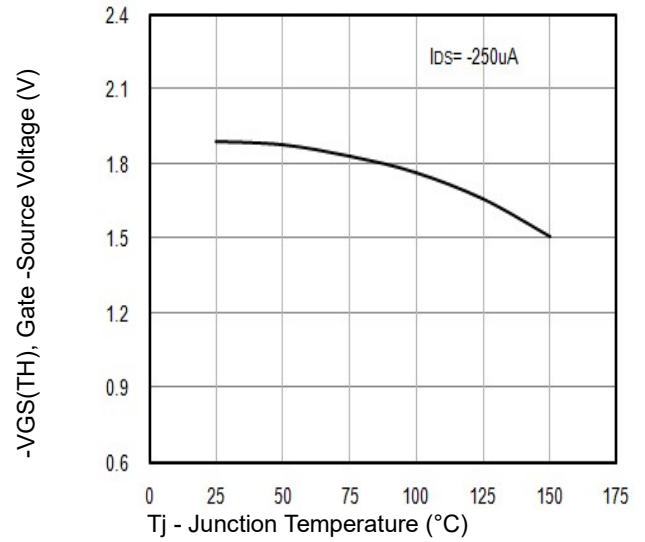

Fig2. $-V_{GS(TH)}$ Gate -Source Voltage Vs. T_j

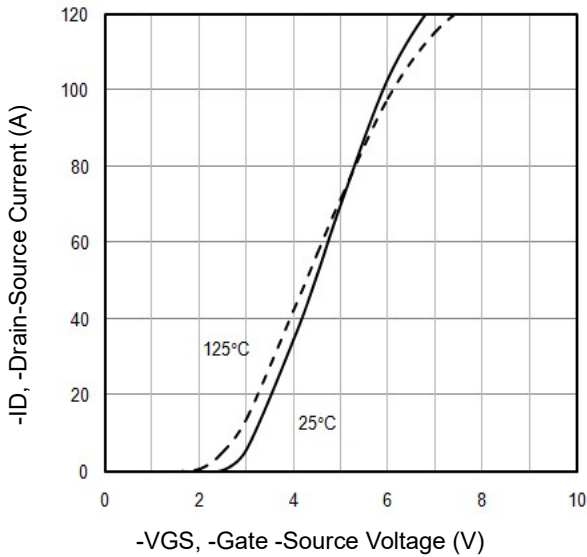

Fig3. Typical Transfer Characteristics

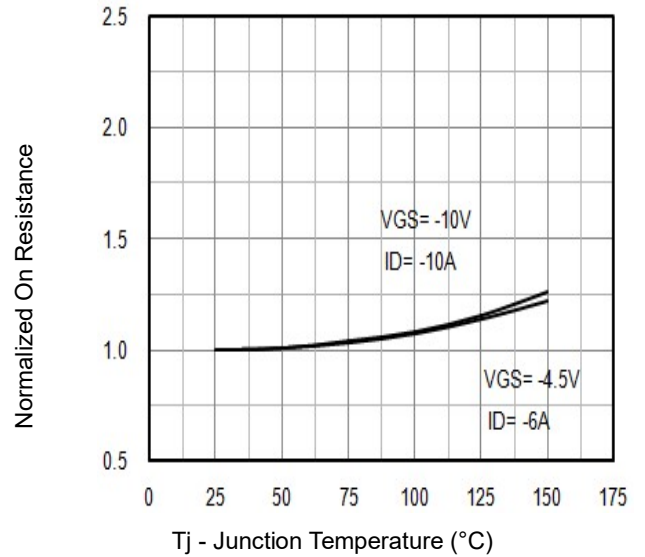

Fig4. Normalized On-Resistance Vs. T_j

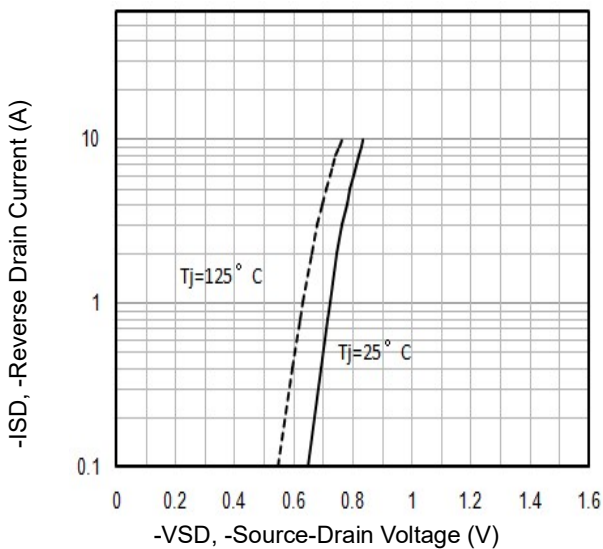

Fig5. Typical Source-Drain Diode Forward Voltage

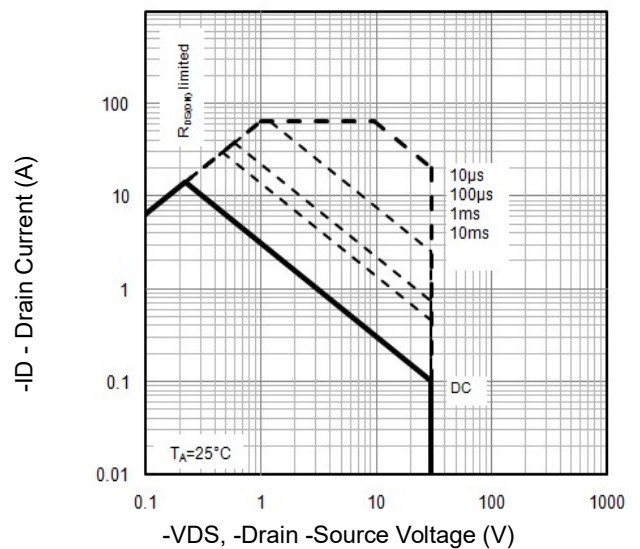

Fig6. Maximum Safe Operating Area

Typical Characteristics

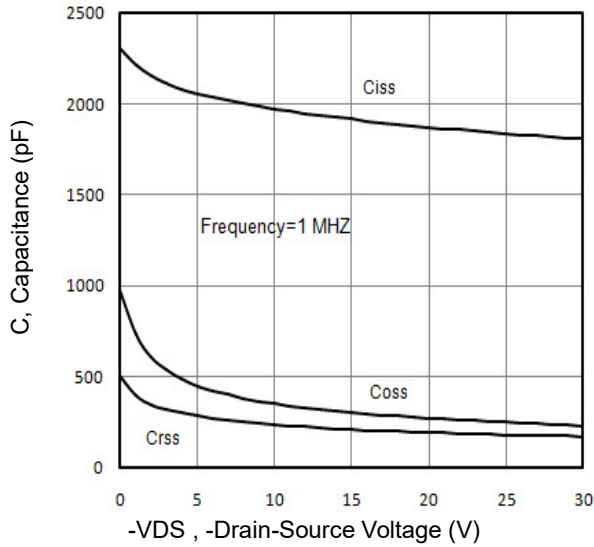

Fig7. Typical Capacitance Vs.Drain-Source Voltage

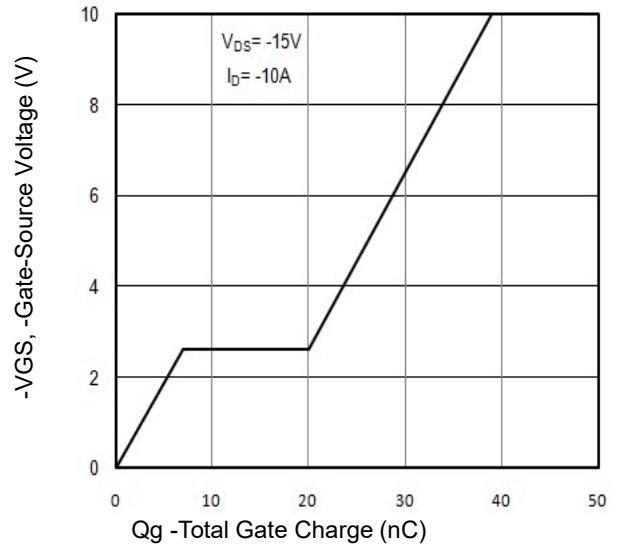

Fig8. Typical Gate Charge Vs.Gate-Source Voltage

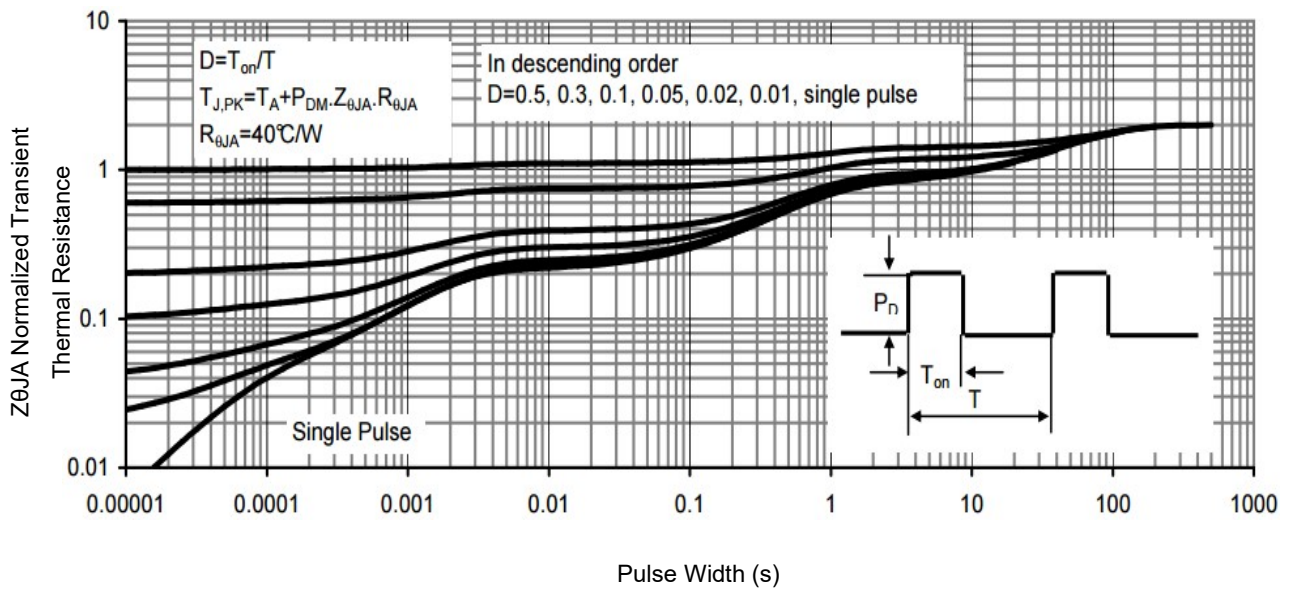

Fig9. Normalized Maximum Transient Thermal Impedance

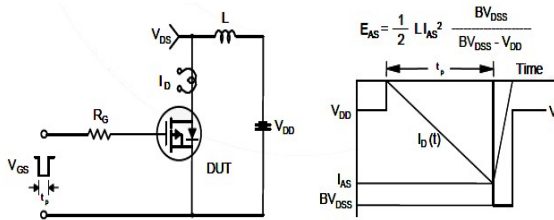

Fig10. Unclamped Inductive Test Circuit and Waveforms

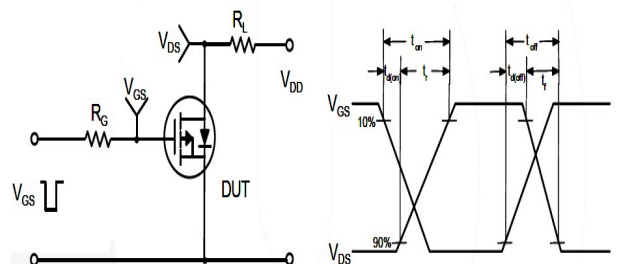
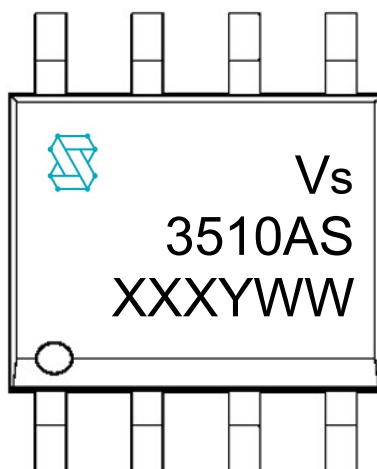

Fig11. Switching Time Test Circuit and waveforms

Marking Information

1st line: Vergiga Code (Vs), Vergiga Logo

2nd line: Part Number (3510AS)

3rd line: Date code (XXXYWW)

XXX: Wafer Lot Number Code , code changed with Lot Number

Y: Year Code , refer to table below

WW: Week Code (01 to 53)

Code	C	D	E	F	G	H	J	K	L	M	N	P	Q	R	S	T
Year	2015	2016	2017	2018	2019	2020	2021	2022	2023	2024	2025	2026	2027	2028	2029	2030

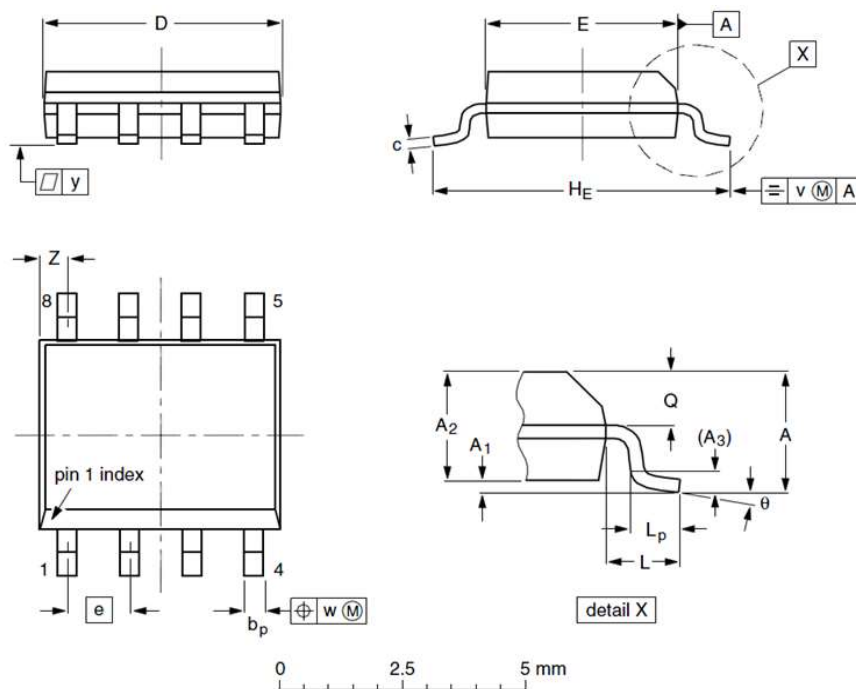
SOP8 Package Outline Data

Label	Dimensions (unit: mm)		
	Min	Typ	Max
A	--	--	1.75
A ₁	0.10	0.18	0.25
A ₂	1.25	1.35	1.50
A ₃	--	0.25	--
b _p	0.36	0.42	0.51
c	0.19	0.22	0.25
D	4.80	4.92	5.00
E	3.80	3.90	4.00
e	--	1.27	--
H _E	5.80	6.00	6.20
L	--	1.05	--
L _p	0.40	0.68	1.00
Q	0.60	0.65	0.725
v	--	0.25	--
w	--	0.25	--
y	--	0.10	--
Z	0.30	0.50	0.70
θ	0°		8°

Notes:

1. Follow JEDEC MS-012.
2. Dimension "D" does NOT include mold flash, protrusions or gate burrs. Mold flash, protrusions or gate burrs shall not exceed 0.15mm per side.
3. Dimension "E" does NOT include interlead flash or protrusion. Interlead flash or protrusion shall not exceed 0.25mm per side.
4. Dimension "b_p" does NOT include dambar protrusion. Allowable dambar protrusion shall be 0.1mm total in excess of "b_p" dimension at maximum material condition. The dambar cannot be located on the lower radius of the foot.

Customer Service
Sales and Service:
sales@vgsemi.com
Vergiga Semiconductor CO., LTD
TEL: (86-755) -26902410

FAX: (86-755) -26907027

WEB: www.vgsemi.com