

## S3T-HF Thru. S3Y-HF

Reverse Voltage: 1300 to 2000 V

Forward Current: 3 A

RoHS Device

Halogen Free

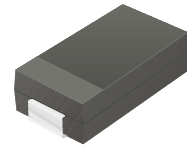

### Features

- Glass Passivated Die Construction
- Low Forward Voltage Drop and High Current Capability
- Surge Overload Rating to 100A Peak
- Ideally Suited for Automated Assembly
- Available in Lead Free Version

### Circuit diagram

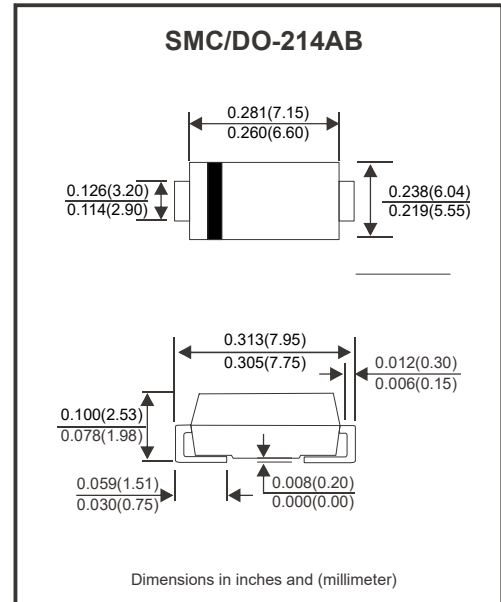

### Maximum Ratings and Electrical Characteristics

Parameter	Symbol	S3T-HF	S3W-HF	S3Y-HF	Units
Repetitive peak reverse voltage	$V_{RRM}$	1300	1600	2000	V
DC blocking voltage	$V_R$	1300	1600	2000	V
RMS voltage	$V_{RMS}$	910	1120	1400	V
Peak forwardsurge current: 8.3ms single half sine-wave superimposed on rated load	$I_{FSM}$	100.0			A
Average forward current	$I_{F(AV)}$	3.0			A
Forward voltage at 3.0A	$V_F$	1.1			V
DC reverse current	$I_R$	$T_J=25^{\circ}C$	10		$\mu A$
DC blocking voltage		$T_J=125^{\circ}C$	250		
Typical thermal resistance	$R_{\theta JC}$	10			$^{\circ}C/W$
Operating temperature range	$T_J$	-65 to +150			$^{\circ}C$
Storage temperature range	$T_{STG}$	-65 to +150			$^{\circ}C$

Notes: 1. P.C.B mounted with 0.2x0.2" (5.0x5.0mm) copper pad areas.  
 2. Measured at 1.0 MHz and applied reverse voltage of 4.0 V DC.

Company reserves the right to improve product design, functions and reliability without notice.

REV:A

Fig.1 - Forward Current Derating Curve

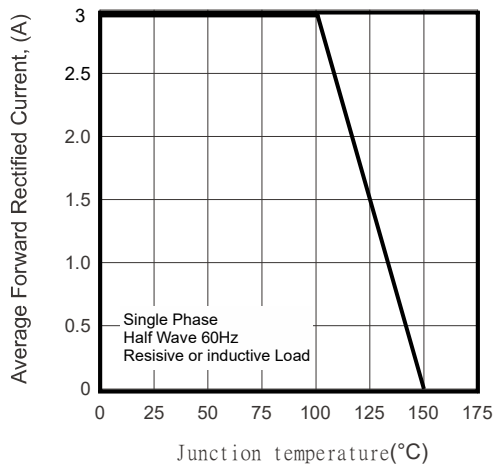
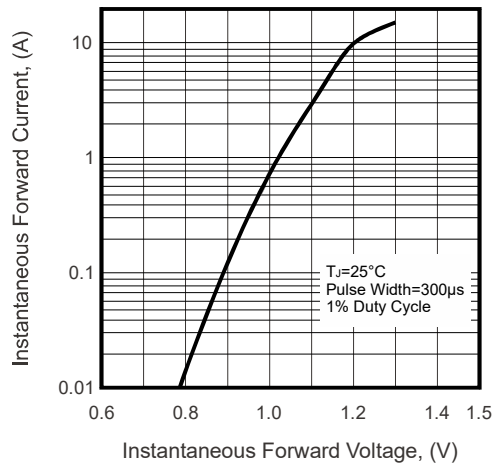
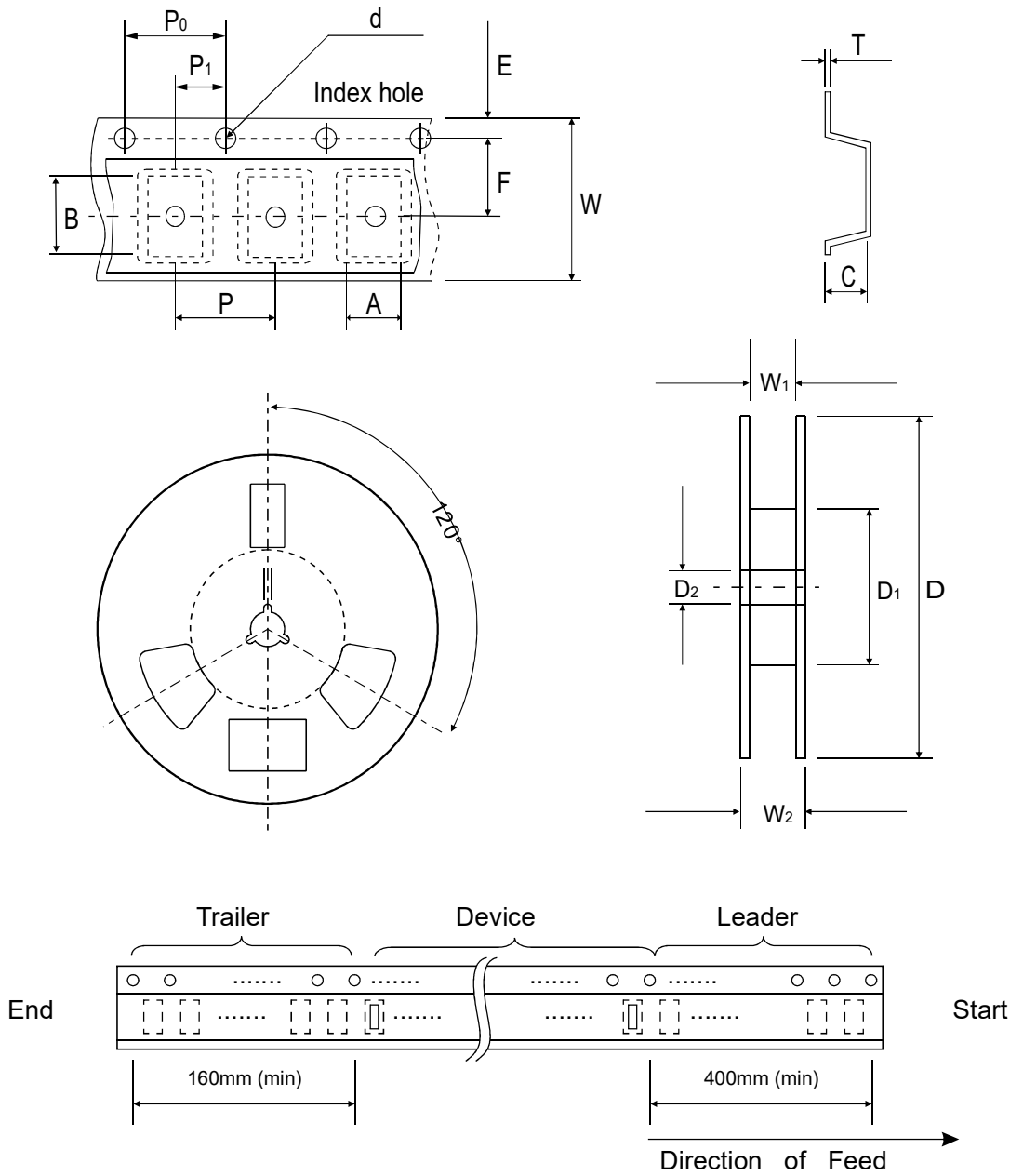

Fig.2 - Typical Instantaneous Forward Characteristics



## Reel Taping Specification



DO-214AB (SMC)	SYMBOL	A	B	C	d	T	D	D <sub>1</sub>	D <sub>2</sub>	
	(mm)	See Note 1				1.55 ± 0.05	0.40 (Max.)	330.00	50.00 (Min.)	13.00 <sup>+0.50</sup> <sub>-0.20</sub>
	(inch)	See Note 1				0.061 ± 0.002	0.016 (Max.)	13.000	1.969 (Min.)	0.512 <sup>+0.020</sup> <sub>-0.008</sub>

DO-214AB (SMC)	SYMBOL	E	F	P	P <sub>0</sub>	P <sub>1</sub>	W	W <sub>1</sub>	W <sub>2</sub>
	(mm)	1.75 ± 0.10	7.50 ± 0.05	8.00 ± 0.10	4.00 ± 0.10	2.00 ± 0.05	16.00 ± 0.10	16.40 <sup>+2.00</sup> <sub>-0.00</sub>	22.40 (Max.)
	(inch)	0.069 ± 0.004	0.295 ± 0.002	0.315 ± 0.004	0.157 ± 0.004	0.079 ± 0.002	0.630 ± 0.004	0.646 <sup>+0.079</sup> <sub>-0.000</sub>	0.882 (Max.)

Notes: 1. A, B, and C the clearance between the component and the cavity must be within 0.5 mm max. for 8 mm tape and 12 mm tape, 1.0 mm max. for 16mm tape and 24 mm tape.

Company reserves the right to improve product design , functions and reliability without notice.

REV:A

## Marking Code

Part Number	Marking code
S3T-HF	S3T
S3W-HF	S3W
S3Y-HF	S3Y

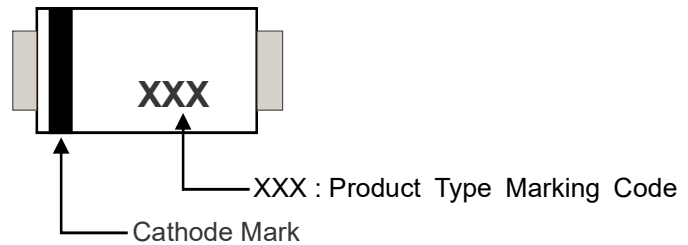

## Suggested PAD Layout

SIZE	DO-214AB(SMC)	
	(mm)	(inch)
A	8.13	0.320
B	4.69 MAX	0.185 MAX
C	1.52 MIN	0.06 MIN
D	3.20 MIN	0.126 MIN

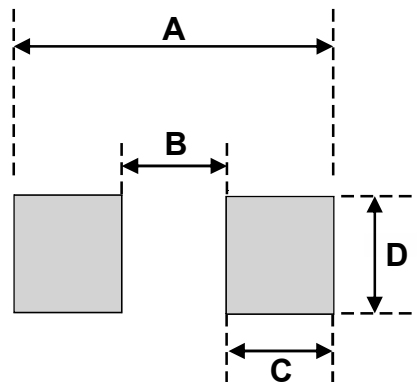

## Standard Packaging

Case Type	REEL PACK	
	REEL ( pcs )	Reel Size (inch)
DO-214AB (SMC)	3,000	13