

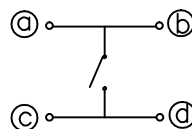

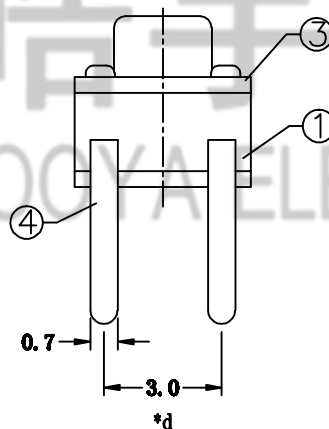

SCHMATIC

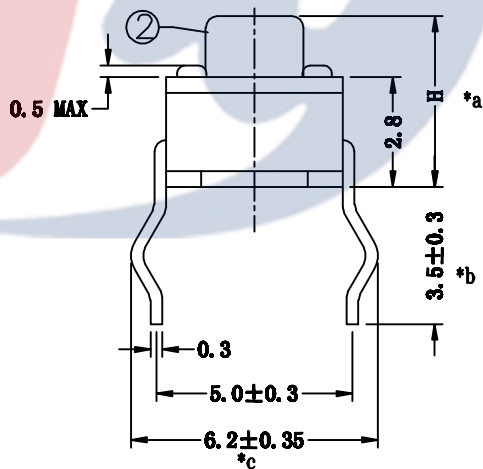
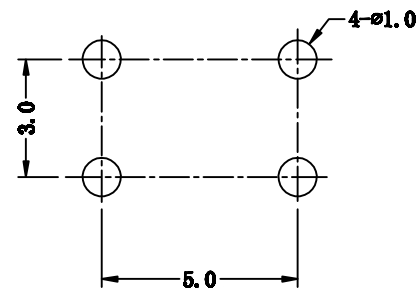

**P.C.B LAYOUT
TOP VIEW**



H=38mm
E: 操作力250gf

					TOLERANCE UNLESS SPECIFIED						
					UP TO 5mm: ±0.1	ANGULAR	1				
					ABOVE 5mm: ±0.2	±1°	NO	DATE	REVISIONS	BY	APPD
4	CONTACT FOOT	BRASS	4	AG-PLATED	TITLE:TACT SWITCH			UNIT : MM	ROHS	DWN	
3	COAT	IRON	1	Ni-PLATED	MODEL: TC-00204-038E			SCALE: 1:1	COMPLIANT	CHK'D	
2	BUTTON	PBT	1		 HAOYU(HONG KONG)LIMITED 皓宇(香港)有限公司			APPD			
1	HOUSING	PBT	1					PRO.AGL:  		REV :A0	
NO.	PART	NAME	MATERIAL	QTY	FINISHING						