

Features

- ◆ The plastic package carries Underwriters Laboratory Flammability Classification 94V-0
- ◆ For surface mounted applications
- ◆ Metal silicon junction, majority carrier conduction
- ◆ Low power loss, high efficiency
- ◆ Built-in strain relief, ideal for automated placement
- ◆ High forward surge current capability
- ◆ High temperature soldering guaranteed: 250°C/10 seconds at terminals
- ◆ Compliant to RoHS Directive 2011/65/EU
- ◆ Suffix "-H" indicates Halogen-free part, ex. SS14-A-H

Mechanical data

- ◆ **Case:** JEDEC DO-214AC molded plastic body
- ◆ **Terminals:** Solder plated, solderable per MIL-STD-750, Method 2026
- ◆ **Polarity:** Color band denotes cathode end
- ◆ **Mounting Position:** Any

Package outline

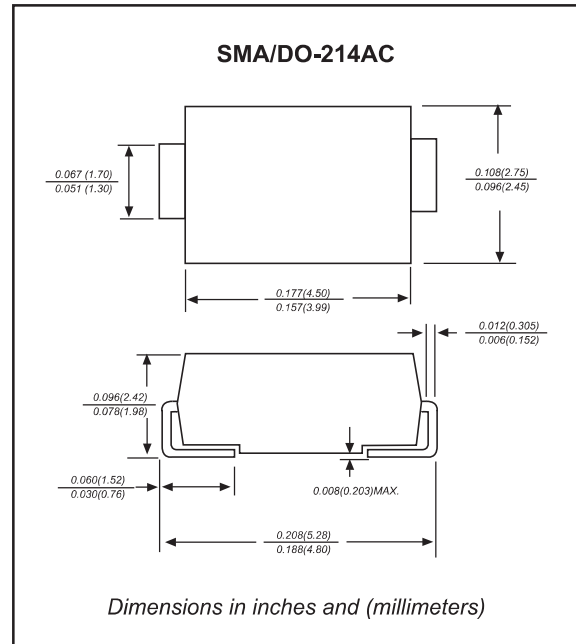

Maximum ratings and Electrical Characteristics (AT $T_A=25^\circ\text{C}$ unless otherwise noted)

PARAMETER	CONDITIONS	Symbol	MIN.	TYP.	MAX.	UNIT
Forward rectified current	See Fig.2	I_O			1.0	A
Forward surge current	8.3ms single half sine-wave (JEDEC methode)	I_{FSM}			30	A
Reverse current	$V_R = V_{RRM} \quad T_A = 25^\circ\text{C}$	I_R			0.5	mA
	$V_R = V_{RRM} \quad T_A = 100^\circ\text{C}$				10	
Thermal resistance	Junction to ambient NOTE 1	$R_{\theta JA}$		88		$^\circ\text{C/W}$
Diode junction capacitance	f=1MHz and applied 4V DC reverse voltage	C_J		110		pF
Storage temperature		T_{STG}	-65		+150	$^\circ\text{C}$

Note: 1.P.C.B. mounted with 0.2x0.2"(5.0x5.0mm) copper pad areas

SYMBOLS	V_{RM}^{*1} (V)	V_{RMS}^{*2} (V)	V_R^{*3} (V)	V_F^{*4} (V)	Operating temperature T_J , ($^\circ\text{C}$)
SS12-A	20	14	20	0.55	-55 to +125
SS13-A	30	21	30		
SS14-A	40	28	40		
SS15-A	50	35	50	0.70	-55 to +150
SS16-A	60	42	60		
SS18-A	80	56	80	0.85	
SS110-A	100	70	100		
SS115-A	150	105	150	0.92	
SS120-A	200	140	200		

*1 Repetitive peak reverse voltage

*2 RMS voltage



*3 Continuous reverse voltage

*4 Maximum forward voltage@ $I_F=1.0\text{A}$

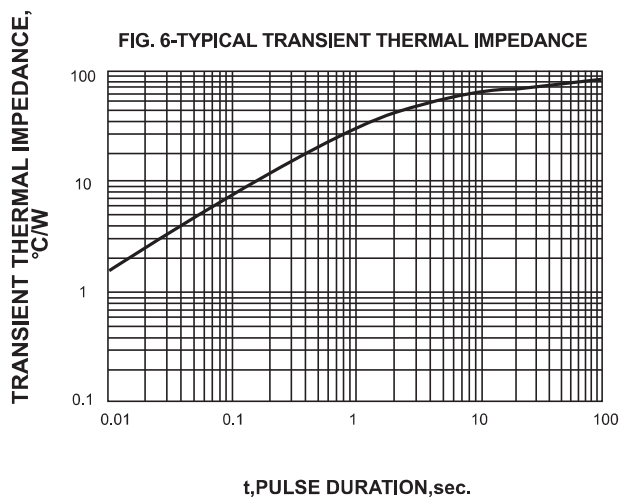
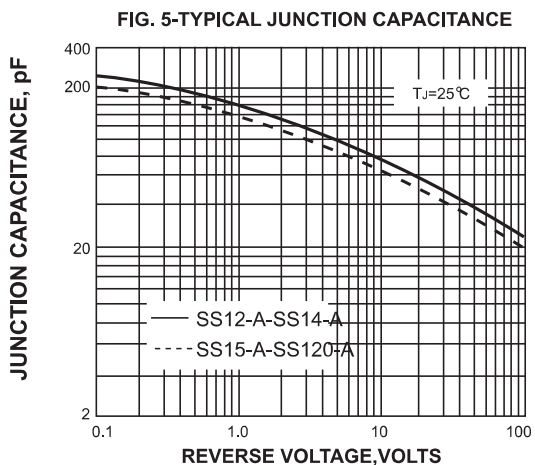
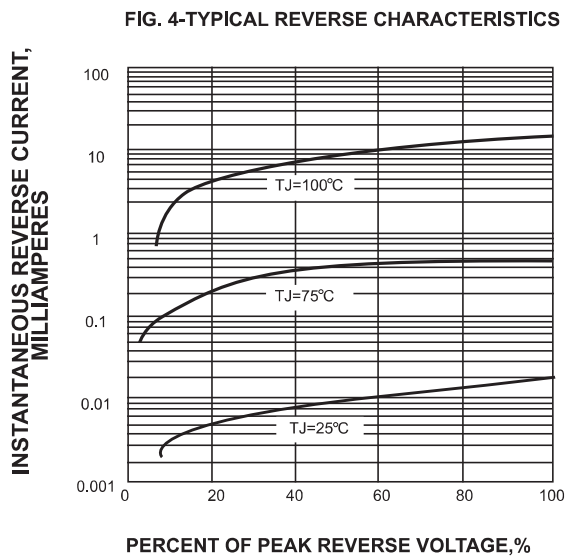
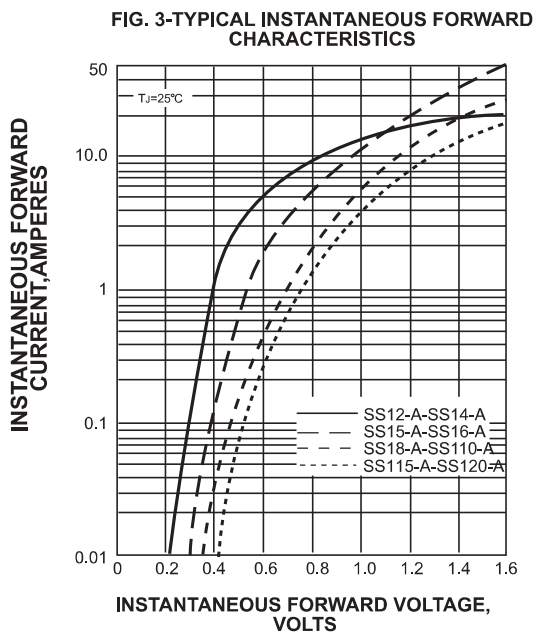
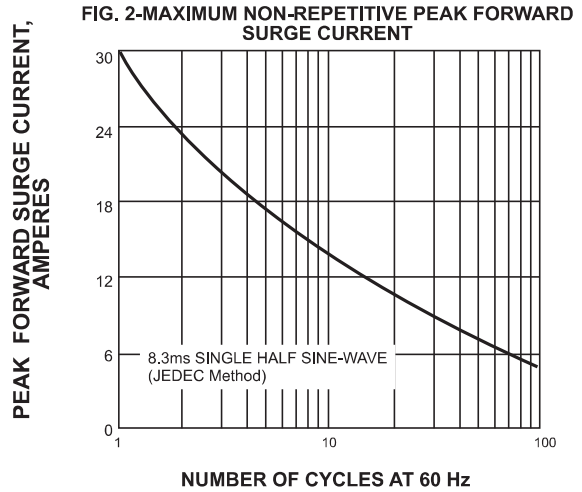
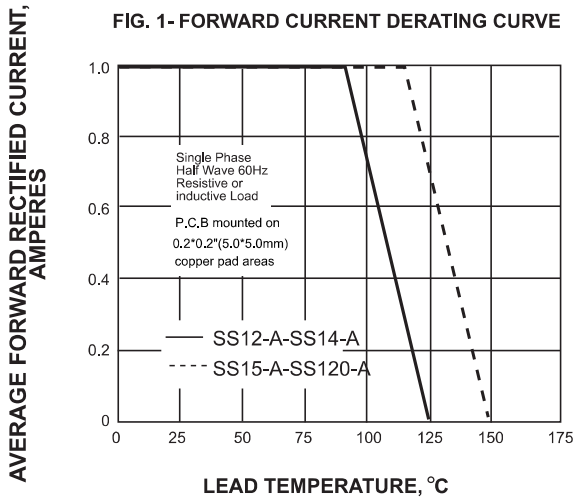
Rating and characteristic curves



Pinning information

Pin	Simplified outline	Symbol
Pin1 cathode Pin2 anode		

Marking

Type number	Marking code	Example	
SS12-A	SS12	For Halogen Device	For Halogen-free Device
SS13-A	SS13		
SS14-A	SS14		
SS15-A	SS15		
SS16-A	SS16		
SS18-A	SS18		
SS110-A	SS110		
SS115-A	SS115		
SS120-A	SS120		

Suggested solder pad layout

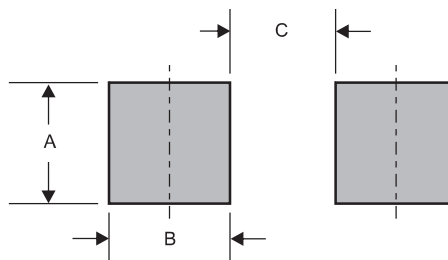

Dimensions in inches and (millimeters)

PACKAGE	A	B	C
SMA	0.110 (2.80)	0.063 (1.60)	0.087 (2.20)